

U.S.-Canada Power System Outage Task Force

**Final Report on the
August 14, 2003 Blackout
in the
United States and Canada:**

**Causes and
Recommendations**

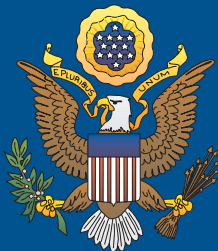

Canada

April 2004

U.S.-Canada Power System Outage Task Force

**Final Report on the
August 14, 2003 Blackout
in the
United States and Canada:**

**Causes and
Recommendations**



Canada

April 2004

U.S.-Canada Power System Outage Task Force



Canada

March 31, 2004

Dear Mr. President and Prime Minister:

We are pleased to submit the Final Report of the U.S.-Canada Power System Outage Task Force. As directed by you, the Task Force has completed a thorough investigation of the causes of the August 14, 2003 blackout and has recommended actions to minimize the likelihood and scope of similar events in the future.

The report makes clear that this blackout could have been prevented and that immediate actions must be taken in both the United States and Canada to ensure that our electric system is more reliable. First and foremost, compliance with reliability rules must be made mandatory with substantial penalties for non-compliance.

We expect continued collaboration between our two countries to implement this report's recommendations. Failure to implement the recommendations would threaten the reliability of the electricity supply that is critical to the economic, energy and national security of our countries.

The work of the Task Force has been an outstanding example of close and effective cooperation between the U.S. and Canadian governments. Such work will continue as we strive to implement the Final Report's recommendations. We resolve to work in cooperation with Congress, Parliament, states, provinces and stakeholders to ensure that North America's electric grid is robust and reliable.

We would like to specifically thank the members of the Task Force and its Working Groups for their efforts and support as we investigated the blackout and moved toward completion of the Final Report. All involved have made valuable contributions. We submit this report with optimism that its recommendations will result in better electric service for the people of both our nations.

Sincerely,

A handwritten signature in blue ink that reads "Spencer Abraham".

U.S. Secretary of Energy

A handwritten signature in black ink that reads "R. John Hood".

Minister of Natural Resources Canada

Contents

	Page
1. Introduction	1
2. Overview of the North American Electric Power System and Its Reliability Organizations	5
The North American Power Grid Is One Large, Interconnected Machine	5
Planning and Reliable Operation of the Power Grid Are Technically Demanding	6
Reliability Organizations Oversee Grid Reliability in North America	10
Key Parties in the Pre-Cascade Phase of the August 14 Blackout	12
3. Causes of the Blackout and Violations of NERC Standards	17
Summary	17
The Causes of the Blackout in Ohio	17
Linking Causes to Specific Weaknesses	17
Institutional Issues	21
4. Context and Preconditions for the Blackout: The Northeastern Power Grid	
Before the Blackout Began	23
Summary	23
Electric Demands on August 14	25
Generation Facilities Unavailable on August 14	25
Unanticipated Outages of Transmission and Generation on August 14	27
Key Parameters for the Cleveland-Akron Area at 15:05 EDT	27
Power Flow Patterns	28
Voltages and Voltage Criteria	31
Past System Events and Adequacy of System Studies	37
Model-Based Analysis of the State of the Regional Power System at 15:05 EDT, Before the Loss of FE's Harding-Chamberlin 345-kV Line	41
System Frequency	43
Conclusion	44
5. How and Why the Blackout Began in Ohio	45
Summary	45
Chapter Organization	45
Phase 1: A Normal Afternoon Degrades: 12:15 EDT to 14:14 EDT	45
Phase 2: FE's Computer Failures: 14:14 EDT to 15:59 EDT	51
Phase 3: Three FE 345-kV Transmission Line Failures and Many Phone Calls: 15:05 EDT to 15:57 EDT	57
Phase 4: 138-kV Transmission System Collapse in Northern Ohio: 15:39 to 16:08 EDT	68
6. The Cascade Stage of the Blackout	73
Phase 5: 345-kV Transmission System Cascade in Northern Ohio and South-Central Michigan	77
Phase 6: The Full Cascade	82
Phase 7: Several Electrical Islands Formed in Northeast U.S. and Canada: 16:10:46 EDT to 16:12 EDT	90
Why the Blackout Stopped Where It Did	91
Under-Frequency and Under-Voltage Load-Shedding	92
Why the Generators Tripped Off	93
7. The August 14 Blackout Compared With Previous Major North American Outages	103
Incidence and Characteristics of Power System Outages	103
Outage Descriptions and Major Causal Factors	104
Common or Similar Factors Among Major Outages	107
Comparisons With the August 14 Blackout	110

Contents (Continued)

Page

8. Performance of Nuclear Power Plants Affected by the Blackout. 111

- Introduction 111
- Findings of the U.S. Nuclear Working Group 112
- Findings of the Canadian Nuclear Working Group 121
- Perspective of Nuclear Regulatory Agencies on Potential Changes to the Grid 129

9. Physical and Cyber Security Aspects of the Blackout 131

- Summary and Primary Findings 131
- SWG Mandate and Scope 132
- Cyber Security in the Electricity Sector 132
- Information Collection and Analysis 133
- Cyber Timeline 136

10. Recommendations to Prevent or Minimize the Scope of Future Blackouts 139

- Introduction 139
- Recommendations. 140

Appendixes

- A. Members of the U.S.-Canada Power System Outage Task Force and Its Three Working Groups . . . 175
- B. Description of Outage Investigation and Process for Development of Recommendations 179
- C. List of Commenters 189
- D. NERC Actions to Prevent and Mitigate the Impacts of Future Cascading Blackouts. 193
- E. List of Electricity Acronyms. 211
- F. Electricity Glossary 213
- G. Transmittal Letters from the Three Working Groups. 221

Tables

- 4.1. Generators Not Available on August 14. 26
- 4.2. Benchmarking Model Results to Actual 28
- 4.3. Comparison of Voltage Criteria (Percent) 33
- 7.1. Changing Conditions That Affect System Reliability 104
- 8.1. U.S. Nuclear Plant Trip Times 116
- 8.2. Summary of Events for U. S. Nuclear Power Plants. 120
- 8.3. Summary of Shutdown Events for Canadian Nuclear Power Plants 128

Figures

- 2.1. Basic Structure of the Electric System 5
- 2.2. North American Interconnections. 6
- 2.3. PJM Load Curve, August 18-24, 2003 7
- 2.4. Normal and Abnormal Frequency Ranges. 7
- 2.5. NERC Regions 11
- 2.6. NERC Regions and Control Areas 12
- 2.7. NERC Reliability Coordinators 13
- 2.8. Reliability Coordinators and Control Areas in Ohio and Surrounding States. 13
- 4.1. August 2003 Temperatures in the U.S. Northeast and Eastern Canada. 25
- 4.2. Load Forecasts Below Actuals, August 11 through 14. 25
- 4.3. MW and MVar Output from Eastlake Unit 5 on August 14. 27
- 4.4. Generation, Demand, and Interregional Power Flows on August 14, 2003, at 15:05 EDT. 29

4.5. Scheduled Imports and Exports for the Northeast Central Region, June 1 through August 13, 2003	29
4.6. Impacts of Transactions Flows on Critical Line Loadings, August 14, 2003	30
4.7. Actual Voltages Across the Ohio Area Before and On August 14, 2003.	34
4.8. Reactive Reserves Around Ohio on August 14, 2003, for Representative Generators in the Area.	37
4.9. Loss of the Perry Unit Hurts Critical Voltages and Reactive Reserves: V-Q Analyses	42
4.10. Impact of Perry Unit Outage on Cleveland-Akron Area Voltage Stability	43
4.11. Frequency on August 14, 2003, up to 16:09 EDT	43
4.12. Hourly Deviations in Eastern Interconnection Frequency for the Month of August 2003	44
5.1. Timeline: Start of the Blackout in Ohio	46
5.2. Timeline Phase 1	48
5.3. Eastlake Unit 5	49
5.4. Timeline Phase 2	52
5.5. FirstEnergy 345-kV Line Flows	57
5.6. Voltages on FirstEnergy’s 345-kV Lines: Impacts of Line Trips	57
5.7. Timeline Phase 3	58
5.8. Harding-Chamberlin 345-kV Line	60
5.9. Hanna-Juniper 345-kV Line	61
5.10. Cause of the Hanna-Juniper Line Loss	62
5.11. Star-South Canton 345-kV Line	63
5.12. Cumulative Effects of Sequential Outages on Remaining 345-kV Lines	64
5.13. Timeline Phase 4	68
5.14. Voltages on FirstEnergy’s 138-kV Lines: Impact of Line Trips.	68
5.15. Simulated Effect of Prior Outages on 138-kV Line Loadings	70
6.1. Rate of Line and Generator Trips During the Cascade	74
6.2. Area Affected by the Blackout	75
6.3. Sammis-Star 345-kV Line Trip, 16:05:57 EDT.	77
6.4. Sammis-Star 345-kV Line Trip	78
6.5. Line Flows Into Michigan	78
6.6. Ohio 345-kV Lines Trip, 16:08:59 to 16:09:07 EDT	79
6.7. New York-Ontario Line Flows at Niagara	79
6.8. First Power Swing Has Varying Impacts Across the Grid	80
6.9. Map of Zone 3 (and Zone 2s Operating Like Zone 3s) Relay Operations on August 14, 2003	81
6.10. Michigan and Ohio Power Plants Trip.	82
6.11. Transmission and Generation Trips in Michigan, 16:10:36 to 16:10:37 EDT	83
6.12. Flows on Keith-Waterman 230-kV Ontario-Michigan Tie Line.	83
6.13. Simulated 345-kV Line Loadings from 16:05:57 through 16:10:38.4 EDT	84
6.14. Simulated Regional Interface Loadings from 16:05:57 through 16:10:38.4 EDT.	84
6.15. Michigan Lines Trip and Ohio Separates from Pennsylvania, 16:10:36 to 16:10:38.6 EDT	85
6.16. Active and Reactive Power and Voltage from Ontario into Detroit	86
6.17. Measured Power Flows and Frequency Across Regional Interfaces, 16:10:30 to 16:11:00 EDT, with Key Events in the Cascade	86
6.18. Cleveland and Toledo Islanded, 16:10:39 to 16:10:46 EDT	88
6.19. Generators Under Stress in Detroit, as Seen from Keith PSDR	88
6.20. Western Pennsylvania Separates from New York, 16:10:39 EDT to 16:10:44 EDT	89
6.21. Northeast Separates from Eastern Interconnection, 16:10:45 EDT	89
6.22. PJM to New York Interties Disconnect.	90
6.23. New York and New England Separate, Multiple Islands Form	91
6.24. Generator Trips by Time and Cause.	95
6.25. Events at One Large Generator During the Cascade	96

Figures (Continued)

Page

6.26. Measured Power Flows and Frequency Across Regional Interfaces, 16:10:45 to 16:11:30 EDT, with Key Events in the Cascade 97

6.27. Frequency Separation Between Ontario and Western New York 99

6.28. Electric Islands Reflected in Frequency Plot 100

6.29. Area Affected by the Blackout 100

6.30. Cascade Sequence 101

7.1. North American Power System Outages, 1984-1997 103

1. Introduction

On August 14, 2003, large portions of the Midwest and Northeast United States and Ontario, Canada, experienced an electric power blackout. The outage affected an area with an estimated 50 million people and 61,800 megawatts (MW) of electric load in the states of Ohio, Michigan, Pennsylvania, New York, Vermont, Massachusetts, Connecticut, New Jersey and the Canadian province of Ontario. The blackout began a few minutes after 4:00 pm Eastern Daylight Time (16:00 EDT), and power was not restored for 4 days in some parts of the United States. Parts of Ontario suffered rolling blackouts for more than a week before full power was restored. Estimates of total costs in the United States range between \$4 billion and \$10 billion (U.S. dollars).¹ In Canada, gross domestic product was down 0.7% in August, there was a net loss of 18.9 million work hours, and manufacturing shipments in Ontario were down \$2.3 billion (Canadian dollars).²

On August 15, President George W. Bush and then-Prime Minister Jean Chrétien directed that a joint U.S.-Canada Power System Outage Task Force be established to investigate the causes of the blackout and ways to reduce the possibility of future outages. They named U.S. Secretary of Energy Spencer Abraham and Herb Dhaliwal, Minister of Natural Resources, Canada, to chair the joint Task Force. (Mr. Dhaliwal was later succeeded by Mr. John Efford as Minister of Natural Resources and as co-chair of the Task Force.) Three other U.S. representatives and three other Canadian representatives were named to the Task Force. The U.S. members were Tom Ridge, Secretary of Homeland Security; Pat Wood III, Chairman of the Federal Energy Regulatory Commission; and Nils Diaz, Chairman of the Nuclear Regulatory Commission. The Canadian members were Deputy Prime Minister John Manley, later succeeded by Deputy Prime Minister Anne McLellan; Kenneth Vollman, Chairman of the National Energy Board; and Linda J. Keen, President and CEO of the Canadian Nuclear Safety Commission.

The Task Force divided its work into two phases:

- ◆ Phase I: Investigate the outage to determine its causes and why it was not contained.
- ◆ Phase II: Develop recommendations to reduce the possibility of future outages and reduce the scope of any that occur.

The Task Force created three Working Groups to assist in both phases of its work—an Electric System Working Group (ESWG), a Nuclear Working Group (NWG), and a Security Working Group (SWG). The Working Groups were made up of state and provincial representatives, federal employees, and contractors working for the U.S. and Canadian government agencies represented on the Task Force.

The Task Force published an Interim Report on November 19, 2003, summarizing the facts that the bi-national investigation found regarding the causes of the blackout on August 14, 2003. After November 19, the Task Force's technical investigation teams pursued certain analyses that were not complete in time for publication in the Interim Report. The Working Groups focused on the drafting of recommendations for the consideration of the Task Force to prevent future blackouts and reduce the scope of any that nonetheless occur. In drafting these recommendations, the Working Groups drew substantially on information and insights from the investigation teams' additional analyses, and on inputs received at three public meetings (in Cleveland, New York City, and Toronto) and two technical conferences (in Philadelphia and Toronto). They also drew on comments filed electronically by interested parties on websites established for this purpose by the U.S. Department of Energy and Natural Resources Canada.

Although this Final Report presents some new information about the events and circumstances before the start of the blackout and additional detail concerning the cascade stage of the blackout, none of the comments received or additional

analyses performed by the Task Force’s investigators have changed the validity of the conclusions published in the Interim Report. This report, however, presents findings concerning additional violations of reliability requirements and institutional and performance deficiencies beyond those identified in the Interim Report.

The organization of this Final Report is similar to that of the Interim Report, and it is intended to update and supersede the Interim Report. It is divided into ten chapters, including this introductory chapter:

- ◆ Chapter 2 provides an overview of the institutional framework for maintaining and ensuring the reliability of the bulk power system in North America, with particular attention to the roles and responsibilities of several types of reliability-related organizations.
- ◆ Chapter 3 identifies the causes of the blackout and identifies failures to perform effectively relative to the reliability policies, guidelines, and standards of the North American Electric Reliability Council (NERC) and, in some cases, deficiencies in the standards themselves.
- ◆ Chapter 4 discusses conditions on the regional power system on and before August 14 and identifies conditions and failures that did and did not contribute to the blackout.
- ◆ Chapter 5 describes the afternoon of August 14, starting from normal operating conditions, then going into a period of abnormal but still potentially manageable conditions, and finally into an uncontrollable blackout in northern Ohio.
- ◆ Chapter 6 provides details on the cascade phase of the blackout as it spread in Ohio and then across the Northeast, and explains why the system performed as it did.
- ◆ Chapter 7 compares the August 14, 2003, blackout with previous major North American power outages.
- ◆ Chapter 8 examines the performance of the nuclear power plants affected by the August 14 outage.
- ◆ Chapter 9 addresses issues related to physical and cyber security associated with the outage.

- ◆ Chapter 10 presents the Task Force’s recommendations for preventing future blackouts and reducing the scope of any that occur.

Chapter 10 includes a total of 46 recommendations, but the single most important of them is that the U.S. Congress should enact the reliability provisions in H.R. 6 and S. 2095 to make compliance with reliability standards mandatory and enforceable. If that could be done, many of the other recommended actions could be accomplished readily in the course of implementing the legislation. An overview of the recommendations (by titles only) is provided on pages 3 and 4.

Chapter 2 is very little changed from the version published in the Interim Report. Chapter 3 is new to this Final Report. Chapters 4, 5, and 6 have been revised and expanded from the corresponding chapters (3, 4, and 5) of the Interim Report. Chapters 7, 8, and 9 are only slightly changed from Chapters 6, 7, and 8 of the Interim Report. The Interim Report had no counterpart to Chapter 10.

This report also includes seven appendixes:

- ◆ Appendix A lists the members of the Task Force and the three working groups.
- ◆ Appendix B describes the Task Force’s investigative process for developing the Task Force’s recommendations.
- ◆ Appendix C lists the parties who either commented on the Interim Report, provided suggestions for recommendations, or both.
- ◆ Appendix D reproduces a document released on February 10, 2004 by NERC, describing its actions to prevent and mitigate the impacts of future cascading blackouts.
- ◆ Appendix E is a list of electricity acronyms.
- ◆ Appendix F provides a glossary of electricity terms.
- ◆ Appendix G contains transmittal letters pertinent to this report from the three Working Groups.

Overview of Task Force Recommendations: Titles Only

Group I. Institutional Issues Related to Reliability

1. Make reliability standards mandatory and enforceable, with penalties for noncompliance.
2. Develop a regulator-approved funding mechanism for NERC and the regional reliability councils, to ensure their independence from the parties they oversee.
3. Strengthen the institutional framework for reliability management in North America.
4. Clarify that prudent expenditures and investments for bulk system reliability (including investments in new technologies) will be recoverable through transmission rates.
5. Track implementation of recommended actions to improve reliability.
6. FERC should not approve the operation of new RTOs or ISOs until they have met minimum functional requirements.
7. Require any entity operating as part of the bulk power system to be a member of a regional reliability council if it operates within the council's footprint.
8. Shield operators who initiate load shedding pursuant to approved guidelines from liability or retaliation.
9. Integrate a "reliability impact" consideration into the regulatory decision-making process.
10. Establish an independent source of reliability performance information.
11. Establish requirements for collection and reporting of data needed for post-blackout analyses.
12. Commission an independent study of the relationships among industry restructuring, competition, and reliability.
13. DOE should expand its research programs on reliability-related tools and technologies.
14. Establish a standing framework for the conduct of future blackout and disturbance investigations.

Group II. Support and Strengthen NERC's Actions of February 10, 2004

15. Correct the direct causes of the August 14, 2003 blackout.
16. Establish enforceable standards for maintenance of electrical clearances in right-of-way areas.
17. Strengthen the NERC Compliance Enforcement Program.
18. Support and strengthen NERC's Reliability Readiness Audit Program.
19. Improve near-term and long-term training and certification requirements for operators, reliability coordinators, and operator support staff.
20. Establish clear definitions for *normal*, *alert* and *emergency* operational system conditions. Clarify roles, responsibilities, and authorities of reliability coordinators and control areas under each condition.
21. Make more effective and wider use of system protection measures.
22. Evaluate and adopt better real-time tools for operators and reliability coordinators.
23. Strengthen reactive power and voltage control practices in all NERC regions.
24. Improve quality of system modeling data and data exchange practices.
25. NERC should reevaluate its existing reliability standards development process and accelerate the adoption of enforceable standards.
26. Tighten communications protocols, especially for communications during alerts and emergencies. Upgrade communication system hardware where appropriate.
27. Develop enforceable standards for transmission line ratings.
28. Require use of time-synchronized data recorders.
29. Evaluate and disseminate lessons learned during system restoration.
30. Clarify criteria for identification of operationally critical facilities, and improve dissemination of updated information on unplanned outages.
31. Clarify that the transmission loading relief (TLR) process should not be used in situations involving an actual violation of an Operating Security Limit. Streamline the TLR process.

(continued on page 142)

Overview of Task Force Recommendations: Titles Only (Continued)

Group III. Physical and Cyber Security of North American Bulk Power Systems

32. Implement NERC IT standards.
33. Develop and deploy IT management procedures.
34. Develop corporate-level IT security governance and strategies.
35. Implement controls to manage system health, network monitoring, and incident management.
36. Initiate U.S.-Canada risk management study.
37. Improve IT forensic and diagnostic capabilities.
38. Assess IT risk and vulnerability at scheduled intervals.
39. Develop capability to detect wireless and remote wireline intrusion and surveillance.
40. Control access to operationally sensitive equipment.
41. NERC should provide guidance on employee background checks.
42. Confirm NERC ES-ISAC as the central point for sharing security information and analysis.
43. Establish clear authority for physical and cyber security.
44. Develop procedures to prevent or mitigate inappropriate disclosure of information.

Group IV. Canadian Nuclear Power Sector

45. The Task Force recommends that the Canadian Nuclear Safety Commission request Ontario Power Generation and Bruce Power to review operating procedures and operator training associated with the use of adjuster rods.
46. The Task Force recommends that the Canadian Nuclear Safety Commission purchase and install backup generation equipment.

Endnotes

¹ See “The Economic Impacts of the August 2003 Blackout,” Electric Consumer Research Council (ELCON), February 2, 2004.

² Statistics Canada, *Gross Domestic Product by Industry*, August 2003, Catalogue No. 15-001; *September 2003 Labour Force Survey*; *Monthly Survey of Manufacturing*, August 2003, Catalogue No. 31-001.

2. Overview of the North American Electric Power System and Its Reliability Organizations

The North American Power Grid Is One Large, Interconnected Machine

The North American electricity system is one of the great engineering achievements of the past 100 years. This electricity infrastructure represents more than \$1 trillion (U.S.) in asset value, more than 200,000 miles—or 320,000 kilometers (km) of transmission lines operating at 230,000 volts and greater, 950,000 megawatts of generating capability, and nearly 3,500 utility organizations serving well over 100 million customers and 283 million people.

Modern society has come to depend on reliable electricity as an essential resource for national security; health and welfare; communications; finance; transportation; food and water supply; heating, cooling, and lighting; computers and electronics; commercial enterprise; and even entertainment and leisure—in short, nearly all aspects of modern life. Customers have grown to expect that electricity will almost always be available when needed at the flick of a switch. Most customers have also experienced local outages caused by a car hitting a power pole, a construction crew accidentally damaging a cable, or a

lightning storm. What is not expected is the occurrence of a massive outage on a calm, warm day. Widespread electrical outages, such as the one that occurred on August 14, 2003, are rare, but they can happen if multiple reliability safeguards break down.

Providing reliable electricity is an enormously complex technical challenge, even on the most routine of days. It involves real-time assessment, control and coordination of electricity production at thousands of generators, moving electricity across an interconnected network of transmission lines, and ultimately delivering the electricity to millions of customers by means of a distribution network.

As shown in Figure 2.1, electricity is produced at lower voltages (10,000 to 25,000 volts) at generators from various fuel sources, such as nuclear, coal, oil, natural gas, hydro power, geothermal, photovoltaic, etc. Some generators are owned by the same electric utilities that serve the end-use customer; some are owned by independent power producers (IPPs); and others are owned by customers themselves—particularly large industrial customers.

Electricity from generators is “stepped up” to higher voltages for transportation in bulk over

Figure 2.1. Basic Structure of the Electric System

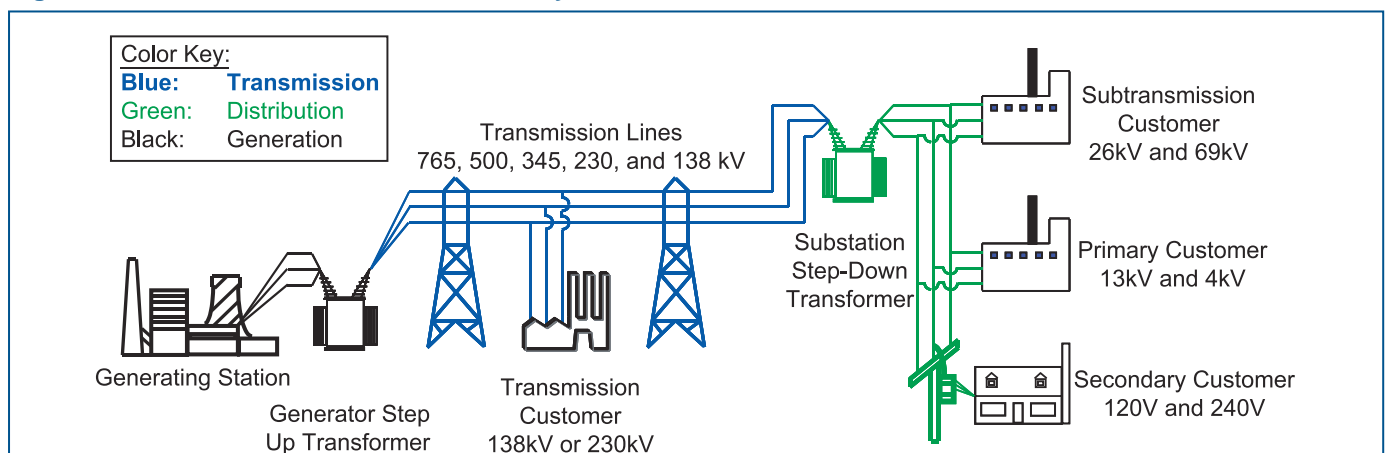

transmission lines. Operating the transmission lines at high voltage (i.e., 230,000 to 765,000 volts) reduces the losses of electricity from conductor heating and allows power to be shipped economically over long distances. Transmission lines are interconnected at switching stations and substations to form a network of lines and stations called a power “grid.” Electricity flows through the interconnected network of transmission lines from the generators to the loads in accordance with the laws of physics—along “paths of least resistance,” in much the same way that water flows through a network of canals. When the power arrives near a load center, it is “stepped down” to lower voltages for distribution to customers. The bulk power system is predominantly an alternating current (AC) system, as opposed to a direct current (DC) system, because of the ease and low cost with which voltages in AC systems can be converted from one level to another. Some larger industrial and commercial customers take service at intermediate voltage levels (12,000 to 115,000 volts), but most residential customers take their electrical service at 120 and 240 volts.

While the power system in North America is commonly referred to as “the grid,” there are actually three distinct power grids or “interconnections” (Figure 2.2). The Eastern Interconnection includes the eastern two-thirds of the continental United States and Canada from Saskatchewan east to the Maritime Provinces. The Western Interconnection includes the western third of the continental United States (excluding Alaska), the Canadian provinces of Alberta and British Columbia, and a portion of Baja California Norte, Mexico. The third interconnection comprises most of the state of Texas. The three interconnections are electrically

independent from each other except for a few small direct current (DC) ties that link them. Within each interconnection, electricity is produced the instant it is used, and flows over virtually all transmission lines from generators to loads.

The northeastern portion of the Eastern Interconnection (about 10 percent of the interconnection’s total load) was affected by the August 14 blackout. The other two interconnections were not affected.¹

Planning and Reliable Operation of the Power Grid Are Technically Demanding

Reliable operation of the power grid is complex and demanding for two fundamental reasons:

- ◆ First, electricity flows at close to the speed of light (186,000 miles per second or 297,600 km/sec) and is not economically storable in large quantities. Therefore electricity must be produced the instant it is used.
- ◆ Second, without the use of control devices too expensive for general use, the flow of alternating current (AC) electricity cannot be controlled like a liquid or gas by opening or closing a valve in a pipe, or switched like calls over a long-distance telephone network.² Electricity flows freely along all available paths from the generators to the loads in accordance with the laws of physics—dividing among all connected flow paths in the network, in inverse proportion to the impedance (resistance plus reactance) on each path.

Maintaining reliability is a complex enterprise that requires trained and skilled operators, sophisticated computers and communications, and careful planning and design. The North American Electric Reliability Council (NERC) and its ten Regional Reliability Councils have developed system operating and planning standards for ensuring the reliability of a transmission grid that are based on seven key concepts:

- ◆ Balance power generation and demand continuously.
- ◆ Balance reactive power supply and demand to maintain scheduled voltages.
- ◆ Monitor flows over transmission lines and other facilities to ensure that thermal (heating) limits are not exceeded.

Figure 2.2. North American Interconnections

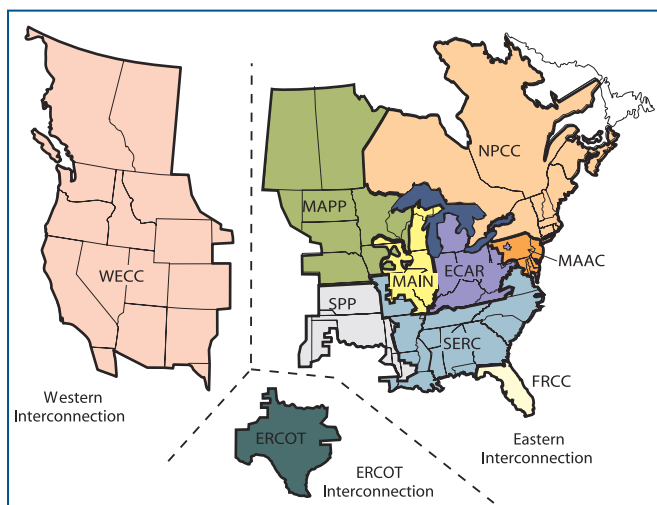

- ◆ Keep the system in a stable condition.
- ◆ Operate the system so that it remains in a reliable condition even if a contingency occurs, such as the loss of a key generator or transmission facility (the “N-1 criterion”).
- ◆ Plan, design, and maintain the system to operate reliably.
- ◆ Prepare for emergencies.

These seven concepts are explained in more detail below.

1. Balance power generation and demand continuously. To enable customers to use as much electricity as they wish at any moment, production by the generators must be scheduled or “dispatched” to meet constantly changing demands, typically on an hourly basis, and then fine-tuned throughout the hour, sometimes through the use of automatic generation controls to continuously match generation to actual demand. Demand is somewhat predictable, appearing as a daily demand curve—in the summer, highest during the afternoon and evening and lowest in the middle of the night, and higher on weekdays when most businesses are open (Figure 2.3).

Failure to match generation to demand causes the frequency of an AC power system (nominally 60 cycles per second or 60 Hertz) to increase (when generation exceeds demand) or decrease (when generation is less than demand) (Figure 2.4). Random, small variations in frequency are normal, as loads come on and off and generators modify their output to follow the demand changes. However, large deviations in frequency can cause the rotational speed of generators to fluctuate, leading to vibrations that can damage generator turbine blades and other equipment. Extreme low frequencies can trigger

Figure 2.3. PJM Load Curve, August 18-24, 2003

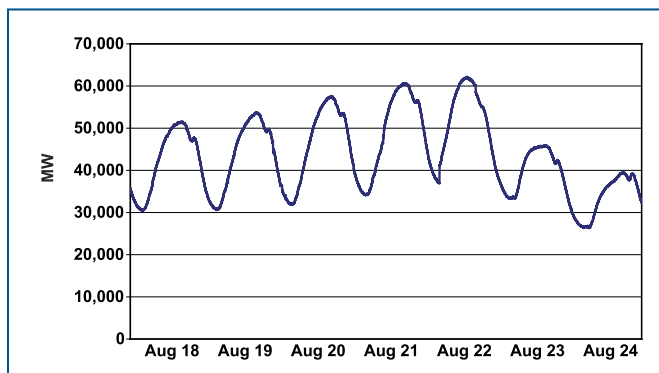

automatic under-frequency “load shedding,” which takes blocks of customers off-line in order to prevent a total collapse of the electric system. As will be seen later in this report, such an imbalance of generation and demand can also occur when the system responds to major disturbances by breaking into separate “islands”; any such island may have an excess or a shortage of generation, compared to demand within the island.

2. Balance reactive power supply and demand to maintain scheduled voltages.

Reactive power sources, such as capacitor banks and generators, must be adjusted during the day to maintain voltages within a secure range pertaining to all system electrical equipment (stations, transmission lines, and customer equipment). Most generators have automatic voltage regulators that cause the reactive power output of generators to increase or decrease to control voltages to scheduled levels. Low voltage can cause electric system instability or collapse and, at distribution voltages, can cause damage to motors and the failure of electronic equipment. High voltages can exceed the insulation capabilities of equipment and cause dangerous electric arcs (“flashovers”).

3. Monitor flows over transmission lines and other facilities to ensure that thermal (heating) limits are not exceeded.

The dynamic interactions between generators and loads, combined with the fact that electricity flows freely across all interconnected circuits, mean that power flow is ever-changing on transmission and distribution lines. All lines, transformers, and other equipment carrying electricity are heated by the flow of electricity through them. The

Figure 2.4. Normal and Abnormal Frequency Ranges

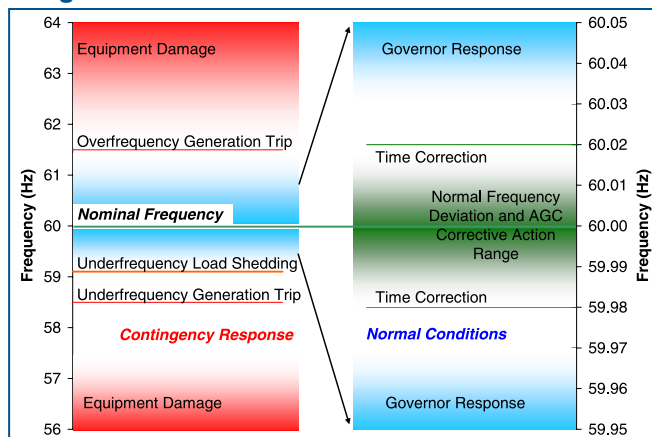

Local Supplies of Reactive Power Are Essential to Maintaining Voltage Stability

A generator typically produces some mixture of “real” and “reactive” power, and the balance between them can be adjusted at short notice to meet changing conditions. Real power, measured in watts, is the form of electricity that powers equipment. Reactive power, a characteristic of AC systems, is measured in volt-amperes reactive (VAR), and is the energy supplied to create or be stored in electric or magnetic fields in and around electrical equipment. Reactive power is particularly important for equipment that relies on magnetic fields for the production of induced electric currents (e.g., motors, transformers, pumps, and air conditioning.) Transmission

lines both consume and produce reactive power. At light loads they are net producers, and at heavy loads, they are heavy consumers. Reactive power consumption by these facilities or devices tends to depress transmission voltage, while its production (by generators) or injection (from storage devices such as capacitors) tends to support voltage. Reactive power can be transmitted only over relatively short distances during heavy load conditions. If reactive power cannot be supplied promptly and in sufficient quantity, voltages decay, and in extreme cases a “voltage collapse” may result.

flow must be limited to avoid overheating and damaging the equipment. In the case of overhead power lines, heating also causes the metal conductor to stretch or expand and sag closer to ground level. Conductor heating is also affected by ambient temperature, wind, and other factors. Flow on overhead lines must be limited to ensure that the line does not sag into obstructions below such as trees or telephone lines, or violate the minimum safety clearances between the energized lines and other objects. (A short circuit or “flashover”—which can start fires or damage equipment—can occur if an energized line gets too close to another object). Most transmission lines, transformers and other current-carrying devices are monitored continuously to ensure that they do not become overloaded or violate other operating constraints. Multiple ratings are typically used, one for normal conditions and a higher rating for emergencies. The primary means of limiting the flow of power on transmission lines is to adjust selectively the output of generators.

4. Keep the system in a stable condition. Because the electric system is interconnected and dynamic, electrical stability limits must be observed. Stability problems can develop very quickly—in just a few cycles (a cycle is 1/60th of a second)—or more slowly, over seconds or minutes. The main concern is to ensure that generation dispatch and the resulting power flows and voltages are such that the system is stable at all times. (As will be described later in this report, part of the Eastern Interconnection became unstable on August 14, resulting in a cascading outage over a wide area.) Stability

limits, like thermal limits, are expressed as a maximum amount of electricity that can be safely transferred over transmission lines.

There are two types of stability limits: (1) Voltage stability limits are set to ensure that the unplanned loss of a line or generator (which may have been providing locally critical reactive power support, as described previously) will not cause voltages to fall to dangerously low levels. If voltage falls too low, it begins to collapse uncontrollably, at which point automatic relays either shed load or trip generators to avoid damage. (2) Power (angle) stability limits are set to ensure that a short circuit or an unplanned loss of a line, transformer, or generator will not cause the remaining generators and loads being served to lose synchronism with one another. (Recall that all generators and loads within an interconnection must operate at or very near a common 60 Hz frequency.) Loss of synchronism with the common frequency means generators are operating out-of-step with one another. Even modest losses of synchronism can result in damage to generation equipment. Under extreme losses of synchronism, the grid may break apart into separate electrical islands; each island would begin to maintain its own frequency, determined by the load/generation balance within the island.

5. Operate the system so that it remains in a reliable condition even if a contingency occurs, such as the loss of a key generator or transmission facility (the “N minus 1 criterion”). The central organizing principle of electricity reliability management is to plan for the unexpected. The unique characteristics of electricity

mean that problems, when they arise, can spread and escalate very quickly if proper safeguards are not in place. Accordingly, through years of experience, the industry has developed a network of defensive strategies for maintaining reliability based on the assumption that equipment can and will fail unexpectedly upon occasion.

This principle is expressed by the requirement that the system must be operated at all times to ensure that it will remain in a secure condition (generally within emergency ratings for current and voltage and within established stability limits) following the loss of the most important generator or transmission facility (a “worst single contingency”). This is called the “N-1 criterion.” In other words, because a generator or line trip can occur at any time from random failure, the power system must be operated in a preventive mode so that the loss of the most important generator or transmission facility

does not jeopardize the remaining facilities in the system by causing them to exceed their emergency ratings or stability limits, which could lead to a cascading outage.

Further, when a contingency does occur, the operators are required to identify and assess immediately the new worst contingencies, given the changed conditions, and promptly make any adjustments needed to ensure that if one of them were to occur, the system would still remain operational and safe. NERC operating policy requires that the system be restored as soon as practical but within no more than 30 minutes to compliance with normal limits, and to a condition where it can once again withstand the next-worst single contingency without violating thermal, voltage, or stability limits. A few areas of the grid are operated to withstand the concurrent loss of two or more facilities (i.e., “N-2”). This may be done, for example, as an added safety measure to protect

Why Don't More Blackouts Happen?

Given the complexity of the bulk power system and the day-to-day challenges of operating it, there are a lot of things that could go wrong—which makes it reasonable to wonder why so few large outages occur.

Large outages or blackouts are infrequent because responsible system owners and operators practice “defense in depth,” meaning that they protect the bulk power system through layers of safety-related practices and equipment. These include:

- 1. A range of rigorous planning and operating studies, including long-term assessments, year-ahead, season-ahead, week-ahead, day-ahead, hour-ahead, and real-time operational contingency analyses.** Planners and operators use these to evaluate the condition of the system, anticipate problems ranging from likely to low probability but high consequence, and develop a good understanding of the limits and rules for safe, secure operation under such contingencies. If multiple contingencies occur in a single area, they are likely to be interdependent rather than random, and should have been anticipated in planning studies.
- 2. Preparation for the worst case.** The operating rule is to always prepare the system to be safe

in the face of the worst single contingency that could occur relative to current conditions, which means that the system is also prepared for less adverse contingencies.

- 3. Quick response capability.** Most potential problems first emerge as a small, local situation. When a small, local problem is handled quickly and responsibly using NERC operating practices—particularly to return the system to N-1 readiness within 30 minutes or less—the problem can usually be resolved and contained before it grows beyond local proportions.
- 4. Maintain a surplus of generation and transmission.** This provides a cushion in day-to-day operations, and helps ensure that small problems don't become big problems.
- 5. Have backup capabilities for all critical functions.** Most owners and operators maintain backup capabilities—such as redundant equipment already on-line (from generation in spinning reserve and transmission operating margin and limits to computers and other operational control systems)—and keep an inventory of spare parts to be able to handle an equipment failure.

a densely populated metropolitan area or when lines share a common structure and could be affected by a common failure mode, e.g., a single lightning strike.

6. Plan, design, and maintain the system to operate reliably. Reliable power system operation requires far more than monitoring and controlling the system in real-time. Thorough planning, design, maintenance, and analysis are required to ensure that the system can be operated reliably and within safe limits. Short-term planning addresses day-ahead and week-ahead operations planning; long-term planning focuses on providing adequate generation resources and transmission capacity to ensure that in the future the system will be able to withstand severe contingencies without experiencing widespread, uncontrolled cascading outages.

A utility that serves retail customers must estimate future loads and, in some cases, arrange for adequate sources of supplies and plan adequate transmission and distribution infrastructure. NERC planning standards identify a range of possible contingencies and set corresponding expectations for system performance under several categories of possible events, ranging from everyday “probable” events to “extreme” events that may involve substantial loss of customer load and generation in a widespread area. NERC planning standards also address requirements for voltage support and reactive power, disturbance monitoring, facility ratings, system modeling and data requirements, system protection and control, and system restoration.

7. Prepare for emergencies. System operators are required to take the steps described above to plan and operate a reliable power system, but emergencies can still occur because of external factors such as severe weather, operator error, or equipment failures that exceed planning, design, or operating criteria. For these rare events, the operating entity is required to have emergency procedures covering a credible range of emergency scenarios. Operators must be trained to recognize and take effective action in response to these emergencies. To deal with a system emergency that results in a blackout, such as the one that occurred on August 14, 2003, there must be procedures and capabilities to use “black start” generators (capable of restarting with no external power source) and to coordinate operations in order to restore the

system as quickly as possible to a normal and reliable condition.

Reliability Organizations Oversee Grid Reliability in North America

NERC is a non-governmental entity whose mission is to ensure that the bulk electric system in North America is reliable, adequate and secure. The organization was established in 1968, as a result of the Northeast blackout in 1965. Since its inception, NERC has operated as a voluntary organization, relying on reciprocity, peer pressure and the mutual self-interest of all those involved to ensure compliance with reliability requirements. An independent board governs NERC.

To fulfill its mission, NERC:

- ◆ Sets standards for the reliable operation and planning of the bulk electric system.
- ◆ Monitors and assesses compliance with standards for bulk electric system reliability.
- ◆ Provides education and training resources to promote bulk electric system reliability.
- ◆ Assesses, analyzes and reports on bulk electric system adequacy and performance.
- ◆ Coordinates with regional reliability councils and other organizations.
- ◆ Coordinates the provision of applications (tools), data and services necessary to support the reliable operation and planning of the bulk electric system.
- ◆ Certifies reliability service organizations and personnel.
- ◆ Coordinates critical infrastructure protection of the bulk electric system.
- ◆ Enables the reliable operation of the interconnected bulk electric system by facilitating information exchange and coordination among reliability service organizations.

Recent changes in the electricity industry have altered many of the traditional mechanisms, incentives and responsibilities of the entities involved in ensuring reliability, to the point that the voluntary system of compliance with reliability standards is generally recognized as not adequate to current needs.³ NERC and many other electricity organizations support the development of a new mandatory system of reliability standards

and compliance, backstopped in the United States by the Federal Energy Regulatory Commission. This will require federal legislation in the United States to provide for the creation of a new electric reliability organization with the statutory authority to enforce compliance with reliability standards among all market participants. Appropriate government entities in Canada and Mexico are prepared to take similar action, and some have already done so. In the meantime, NERC encourages compliance with its reliability standards through an agreement with its members.

NERC’s members are ten regional reliability councils. (See Figure 2.5 for a map showing the locations and boundaries of the regional councils.) In turn, the regional councils have broadened their membership to include all segments of the electric industry: investor-owned utilities; federal power agencies; rural electric cooperatives; state, municipal and provincial utilities; independent power producers; power marketers; and end-use customers. Collectively, the members of the NERC regions account for virtually all the electricity supplied in the United States, Canada, and a portion of Baja California Norte, Mexico. The ten regional councils jointly fund NERC and adapt NERC standards to meet the needs of their regions. The August 14 blackout affected three NERC regional reliability councils—East Central Area Reliability Coordination Agreement (ECAR), Mid-Atlantic Area Council (MAAC), and Northeast Power Coordinating Council (NPCC).

“Control areas” are the primary operational entities that are subject to NERC and regional council standards for reliability. A control area is a geographic area within which a single entity, Independent System Operator (ISO), or Regional Transmission Organization (RTO) balances generation and loads in real time to maintain reliable operation. Control areas are linked with each other through transmission interconnection tie lines. Control area operators control generation directly to maintain their electricity interchange schedules with other control areas. They also operate collectively to support the reliability of their interconnection. As shown in Figure 2.6, there are approximately 140 control areas in North America. The control area dispatch centers have sophisticated monitoring and control systems and are staffed 24 hours per day, 365 days per year.

Traditionally, control areas were defined by utility service area boundaries and operations were largely managed by vertically integrated utilities

that owned and operated generation, transmission, and distribution. While that is still true in some areas, there has been significant restructuring of operating functions and some consolidation of control areas into regional operating entities. Utility industry restructuring has led to an unbundling of generation, transmission and distribution activities such that the ownership and operation of these assets have been separated either functionally or through the formation of independent entities called Independent System Operators (ISOs) and Regional Transmission Organizations (RTOs).

- ◆ ISOs and RTOs in the United States have been authorized by FERC to implement aspects of the Energy Policy Act of 1992 and subsequent FERC policy directives.
- ◆ The primary functions of ISOs and RTOs are to manage in real time and on a day-ahead basis the reliability of the bulk power system and the operation of wholesale electricity markets within their footprint.
- ◆ ISOs and RTOs do not own transmission assets; they operate or direct the operation of assets owned by their members.
- ◆ ISOs and RTOs may be control areas themselves, or they may encompass more than one control area.
- ◆ ISOs and RTOs may also be NERC Reliability Coordinators, as described below.

Five RTOs/ISOs are within the area directly affected by the August 14 blackout. They are:

- ◆ Midwest Independent System Operator (MISO)
- ◆ PJM Interconnection (PJM)

Figure 2.5. NERC Regions

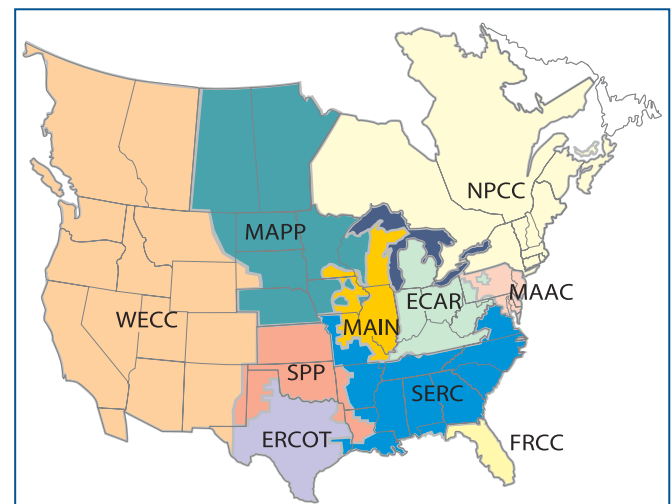

- ◆ New York Independent System Operator (NYISO)
- ◆ New England Independent System Operator (ISO-NE)
- ◆ Ontario Independent Market Operator (IMO)

Reliability coordinators provide reliability oversight over a wide region. They prepare reliability assessments, provide a wide-area view of reliability, and coordinate emergency operations in real time for one or more control areas. They may operate, but do not participate in, wholesale or retail market functions. There are currently 18 reliability coordinators in North America. Figure 2.7 shows the locations and boundaries of their respective areas.

Key Parties in the Pre-Cascade Phase of the August 14 Blackout

The initiating events of the blackout involved two control areas—FirstEnergy (FE) and American

Electric Power (AEP)—and their respective reliability coordinators, MISO and PJM (see Figures 2.7 and 2.8). These organizations and their reliability responsibilities are described briefly in this final subsection.

- 1. FirstEnergy operates a control area in northern Ohio.** FirstEnergy (FE) consists of seven electric utility operating companies. Four of these companies, Ohio Edison, Toledo Edison, The Illuminating Company, and Penn Power, operate in the NERC ECAR region, with MISO serving as their reliability coordinator. These four companies now operate as one integrated control area managed by FE.⁴
- 2. American Electric Power (AEP) operates a control area in Ohio just south of FE.** AEP is both a transmission operator and a control area operator.
- 3. Midwest Independent System Operator (MISO) is the reliability coordinator for FirstEnergy.** The Midwest Independent System

Figure 2.6. NERC Regions and Control Areas

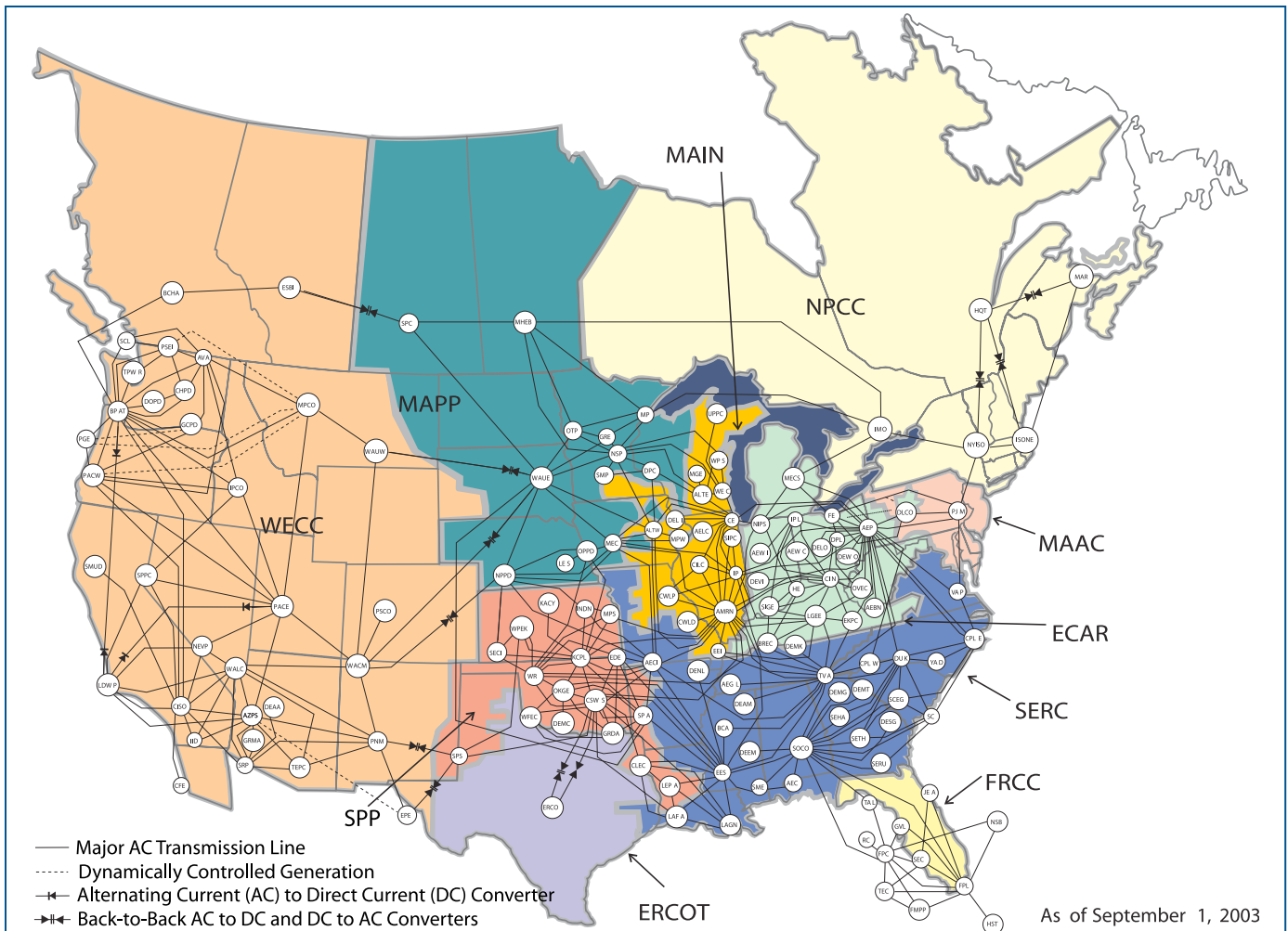

Operator (MISO) is the reliability coordinator for a region of more than 1 million square miles (2.6 million square kilometers), stretching from Manitoba, Canada in the north to Kentucky in the south, from Montana in the west to western Pennsylvania in the east. Reliability coordination is provided by two offices, one in Minnesota, and the other at the MISO headquarters in Indiana. Overall, MISO provides reliability coordination for 37 control areas, most of which are members of MISO.

4. PJM is AEP’s reliability coordinator. PJM is one of the original ISOs formed after FERC orders 888 and 889, but was established as a regional power pool in 1935. PJM recently expanded its footprint to include control areas and transmission operators within MAIN and ECAR (PJM-West). It performs its duties as a reliability coordinator in different ways, depending on the control areas involved. For PJM-East, it is both the control area and reliability coordinator for ten utilities, whose transmission systems span the Mid-Atlantic region of New Jersey, most of Pennsylvania, Delaware, Maryland, West Virginia, Ohio, Virginia, and the District of Columbia. The PJM-West facility has the reliability coordinator desk for five control areas (AEP, Commonwealth Edison, Duquesne Light, Dayton Power and Light, and Ohio Valley Electric Cooperative) and three generation-only control areas (Duke Energy’s Washington County (Ohio) facility, Duke’s Lawrence County/Hanging Rock (Ohio) facility, and Allegheny Energy’s Buchanan (West Virginia) facility.

Reliability Responsibilities of Control Area Operators and Reliability Coordinators

1. Control area operators have primary responsibility for reliability. Their most important responsibilities, in the context of this report, are:

N-1 criterion. NERC Operating Policy 2.A—Transmission Operations:

“All CONTROL AREAS shall operate so that instability, uncontrolled separation, or cascading outages will not occur as a result of the most severe single contingency.”

Emergency preparedness and emergency response. NERC Operating Policy 5—Emergency Operations, General Criteria:

“Each system and CONTROL AREA shall promptly take appropriate action to relieve any abnormal conditions, which jeopardize reliable Interconnection operation.”

“Each system, CONTROL AREA, and Region shall establish a program of manual and automatic load shedding which is designed to arrest frequency or voltage decays that could result in an uncontrolled failure of components of the interconnection.”

NERC Operating Policy 5.A—Coordination with Other Systems:

“A system, CONTROL AREA, or pool that is experiencing or anticipating an operating emergency shall communicate its current and future status to neighboring systems, CONTROL AREAS, or pools and throughout the interconnection A system shall inform

Figure 2.7. NERC Reliability Coordinators

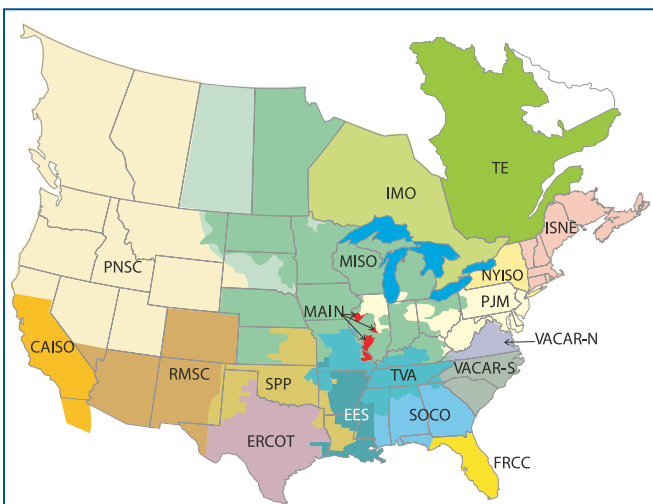
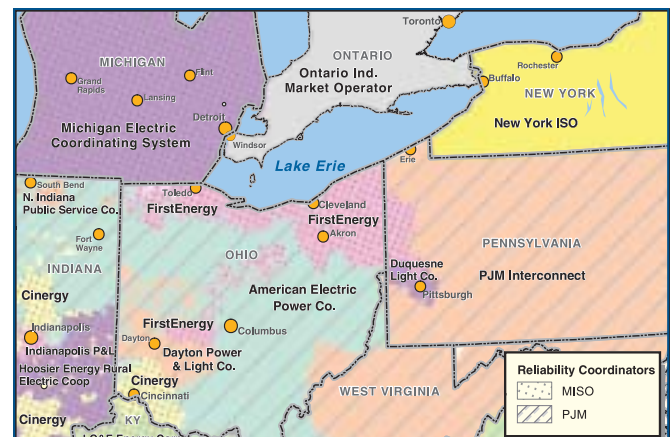

Figure 2.8. Reliability Coordinators and Control Areas in Ohio and Surrounding States



other systems . . . whenever . . . the system’s condition is burdening other systems or reducing the reliability of the Interconnection . . . [or whenever] the system’s line loadings and voltage/reactive levels are such that a single contingency could threaten the reliability of the Interconnection.”

NERC Operating Policy 5.C—Transmission System Relief:

“Action to correct an OPERATING SECURITY LIMIT violation shall not impose unacceptable stress on internal generation or transmission equipment, reduce system reliability beyond acceptable limits, or unduly impose voltage or reactive burdens on neighboring systems. If all other means fail, corrective action may require load reduction.”

Operating personnel and training: NERC Operating Policy 8.B—Training:

“Each OPERATING AUTHORITY should periodically practice simulated emergencies. The scenarios included in practice situations should represent a variety of operating conditions and emergencies.”

2. Reliability Coordinators such as MISO and PJM are expected to comply with all aspects of NERC Operating Policies, especially Policy 9, Reliability Coordinator Procedures, and its appendices. Key requirements include:

NERC Operating Policy 9, Criteria for Reliability Coordinators, 5.2:

Have “detailed monitoring capability of the RELIABILITY AREA and sufficient monitoring

Institutional Complexities and Reliability in the Midwest

The institutional arrangements for reliability in the Midwest are much more complex than they are in the Northeast—i.e., the areas covered by the Northeast Power Coordinating Council (NPCC) and the Mid-Atlantic Area Council (MAAC). There are two principal reasons for this complexity. One is that in NPCC and MAAC, the independent system operator (ISO) also serves as the single control area operator for the individual member systems. In comparison, MISO provides reliability coordination for 35 control areas in the ECAR, MAIN, and MAPP regions and 2 others in the SPP region, and PJM provides reliability coordination for 8 control areas in the ECAR and MAIN regions (plus one in MAAC). (See table below.) This results in 18 control-area-to-control-area interfaces across the PJM/MISO reliability coordinator boundary.

The other is that MISO has less reliability-related authority over its control area members than PJM

has over its members. Arguably, this lack of authority makes day-to-day reliability operations more challenging. Note, however, that (1) FERC’s authority to require that MISO have greater authority over its members is limited; and (2) before approving MISO, FERC asked NERC for a formal assessment of whether reliability could be maintained under the arrangements proposed by MISO and PJM. After reviewing proposed plans for reliability coordination within and between PJM and MISO, NERC replied affirmatively but provisionally. FERC approved the new MISO-PJM configuration based on NERC’s assessment. NERC conducted audits in November and December 2002 of the MISO and PJM reliability plans, and some of the recommendations of the audit teams are still being addressed. The adequacy of the plans and whether the plans were being implemented as written are factors in NERC’s ongoing investigation.

Reliability Coordinator (RC)	Control Areas in RC Area	Regional Reliability Councils Affected and Number of Control Areas	Control Areas of Interest in RC Area
MISO	37	ECAR (12), MAIN (9), MAPP (14), SPP (2)	FE, Cinergy, Michigan Electric Coordinated System
PJM	9	MAAC (1), ECAR (7), MAIN (1)	PJM, AEP, Dayton Power & Light
ISO New England	2	NPCC (2)	ISONE, Maritime Provinces
New York ISO	1	NPCC (1)	NYISO
Ontario Independent Market Operator	1	NPCC (1)	IMO
Trans-Energie	1	NPCC (1)	Hydro Québec

capability of the surrounding RELIABILITY AREAS to ensure potential security violations are identified.”

NERC Operating Policy 9, Functions of Reliability Coordinators, 1.7:

“Monitor the parameters that may have significant impacts within the RELIABILITY AREA and with neighboring RELIABILITY AREAS with respect to . . . sharing with other RELIABILITY COORDINATORS any information regarding potential, expected, or actual critical operating conditions that could negatively impact other RELIABILITY AREAS. The RELIABILITY COORDINATOR will coordinate with other RELIABILITY COORDINATORS and CONTROL AREAS as needed to develop appropriate plans to mitigate negative impacts of potential, expected, or actual critical operating conditions”

What Constitutes an Operating Emergency?

An operating emergency is an unsustainable condition that cannot be resolved using the resources normally available. The NERC Operating Manual defines a “capacity emergency” as when a system’s or pool’s operating generation capacity, plus firm purchases from other systems, to the extent available or limited by transfer capability, is inadequate to meet its demand plus its regulating requirements. It defines an “energy emergency” as when a load-serving entity has exhausted all other options and can no longer provide its customers’ expected energy requirements. A transmission emergency exists when “the system’s line loadings and voltage/ reactive levels are such that a single contingency could threaten the reliability of the Interconnection.” Control room operators and dispatchers are given substantial latitude to determine when to declare an emergency. (See pages 66-67 in Chapter 5 for more detail.)

NERC Operating Policy 9, Functions of Reliability Coordinators, 6:

“Conduct security assessment and monitoring programs to assess contingency situations. Assessments shall be made in real time and for the operations planning horizon at the CONTROL AREA level with any identified problems reported to the RELIABILITY COORDINATOR. The RELIABILITY COORDINATOR is to ensure that CONTROL AREA, RELIABILITY AREA, and regional boundaries are sufficiently modeled to capture any problems crossing such boundaries.”

Endnotes

¹ The province of Québec, although considered a part of the Eastern Interconnection, is connected to the rest of the Eastern Interconnection only by DC ties. In this instance, the DC ties acted as buffers between portions of the Eastern Interconnection; transient disturbances propagate through them less readily. Therefore, the electricity system in Québec was not affected by the outage, except for a small portion of the province’s load that is directly connected to Ontario by AC transmission lines. (Although DC ties can act as a buffer between systems, the tradeoff is that they do not allow instantaneous generation support following the unanticipated loss of a generating unit.)

² In some locations, bulk power flows are controlled through specialized devices or systems, such as phase angle regulators, “flexible AC transmission systems” (FACTS), and high-voltage DC converters (and reconverters) spliced into the AC system. These devices are still too expensive for general application.

³ See, for example, *Maintaining Reliability in a Competitive Electric Industry* (1998), a report to the U.S. Secretary of Energy by the Task Force on Electric Systems Reliability; *National Energy Policy* (2001), a report to the President of the United States by the National Energy Policy Development Group, p. 7-6; and *National Transmission Grid Study* (2002), U.S. Dept. of Energy, pp. 46-48.

⁴ The remaining three FE companies, Penelec, Met-Ed, and Jersey Central Power & Light, are in the NERC MAAC region and have PJM as their reliability coordinator. The focus of this report is on the portion of FE in the ECAR reliability region and within the MISO reliability coordinator footprint.

3. Causes of the Blackout and Violations of NERC Standards

Summary

This chapter explains in summary form the causes of the initiation of the blackout in Ohio, based on the analyses by the bi-national investigation team. It also lists NERC’s findings to date concerning seven specific violations of its reliability policies, guidelines, and standards. Last, it explains how some NERC standards and processes were inadequate because they did not give sufficiently clear direction to industry members concerning some preventive measures needed to maintain reliability, and that NERC does not have the authority to enforce compliance with the standards. Clear standards with mandatory compliance, as contemplated under legislation pending in the U.S. Congress, might have averted the start of this blackout.

Chapters 4 and 5 provide the details that support the conclusions summarized here, by describing conditions and events during the days before and the day of the blackout, and explain how those events and conditions did or did not cause or contribute to the initiation of the blackout. Chapter 6 addresses the cascade as the blackout spread beyond Ohio and reviews the causes and events of the cascade as distinct from the earlier events in Ohio.

The Causes of the Blackout in Ohio

A dictionary definition of “cause” is “something that produces an effect, result, or consequence.”¹ In searching for the causes of the blackout, the investigation team looked back through the progression of sequential events, actions and inactions to identify the cause(s) of each event. The idea of “cause” is here linked not just to what happened or why it happened, but more specifically to the entities whose duties and responsibilities were to anticipate and prepare to deal with the things that could go wrong. Four major causes, or groups of causes, are identified (see box on page 18).

Although the causes discussed below produced the failures and events of August 14, they did not leap into being that day. Instead, as the following chapters explain, they reflect long-standing institutional failures and weaknesses that need to be understood and corrected in order to maintain reliability.

Linking Causes to Specific Weaknesses

Seven violations of NERC standards, as identified by NERC,² and other conclusions reached by NERC and the bi-national investigation team are aligned below with the specific causes of the blackout. There is an additional category of conclusions beyond the four principal causes—the failure to act, when it was the result of preceding conditions. For instance, FE did not respond to the loss of its transmission lines because it did not have sufficient information or insight to reveal the need for action. Note: NERC’s list of violations has been revised and extended since publication of the Interim Report. Two violations (numbers 4 and 6, as cited in the Interim Report) were dropped, and three new violations have been identified in this report (5, 6, and 7, as numbered here). NERC continues to study the record and may identify additional violations.³

Group 1: FirstEnergy and ECAR failed to assess and understand the inadequacies of FE’s system, particularly with respect to voltage instability and the vulnerability of the Cleveland-Akron area, and FE did not operate its system with appropriate voltage criteria and remedial measures.

- ◆ FE did not monitor and manage reactive reserves for various contingency conditions as required by NERC Policy 2, Section B, Requirement 2.
- ◆ NERC Policy 2, Section A, requires a 30-minute period of time to re-adjust the system to prepare to withstand the next contingency.

Causes of the Blackout's Initiation

The Ohio phase of the August 14, 2003, blackout was caused by deficiencies in specific practices, equipment, and human decisions by various organizations that affected conditions and outcomes that afternoon—for example, insufficient reactive power was an issue in the blackout, but it was not a cause in itself. Rather, deficiencies in corporate policies, lack of adherence to industry policies, and inadequate management of reactive power and voltage caused the blackout, rather than the lack of reactive power. There are four groups of causes for the blackout:

Group 1: FirstEnergy and ECAR failed to assess and understand the inadequacies of FE's system, particularly with respect to voltage instability and the vulnerability of the Cleveland-Akron area, and FE did not operate its system with appropriate voltage criteria. (Note: This cause was not identified in the Task Force's Interim Report. It is based on analysis completed by the investigative team after the publication of the Interim Report.)

As detailed in Chapter 4:

- A) FE failed to conduct rigorous long-term planning studies of its system, and neglected to conduct appropriate multiple contingency or extreme condition assessments. (See pages 37-39 and 41-43.)
- B) FE did not conduct sufficient voltage analyses for its Ohio control area and used operational voltage criteria that did not reflect actual voltage stability conditions and needs. (See pages 31-37.)
- C) ECAR (FE's reliability council) did not conduct an independent review or analysis of FE's voltage criteria and operating needs, thereby allowing FE to use inadequate practices without correction. (See page 39.)
- D) Some of NERC's planning and operational requirements and standards were sufficiently ambiguous that FE could interpret them to include practices that were inadequate for reliable system operation. (See pages 31-33.)

Group 2: Inadequate situational awareness at FirstEnergy. FE did not recognize or understand the deteriorating condition of its system.

As discussed in Chapter 5:

- A) FE failed to ensure the security of its transmission system after significant unforeseen contingencies because it did not use an effective contingency analysis capability on a routine basis. (See pages 49-50 and 64.)
- B) FE lacked procedures to ensure that its operators were continually aware of the functional state of their critical monitoring tools. (See pages 51-53, 56.)
- C) FE control center computer support staff and operations staff did not have effective internal communications procedures. (See pages 54, 56, and 65-67.)
- D) FE lacked procedures to test effectively the functional state of its monitoring tools after repairs were made. (See page 54.)
- E) FE did not have additional or back-up monitoring tools to understand or visualize the status of their transmission system to facilitate its operators' understanding of transmission system conditions after the failure of their primary monitoring/alarming systems. (See pages 53, 56, and 65.)

Group 3: FE failed to manage adequately tree growth in its transmission rights-of-way.

This failure was the common cause of the outage of three FE 345-kV transmission lines and one 138-kV line. (See pages 57-64.)

Group 4: Failure of the interconnected grid's reliability organizations to provide effective real-time diagnostic support.

As discussed in Chapter 5:

- A) MISO did not have real-time data from Dayton Power and Light's Stuart-Atlanta 345-kV line incorporated into its state estimator (a system monitoring tool). This precluded

(continued on page 19)

Causes of the Blackout's Initiation (Continued)

MISO from becoming aware of FE's system problems earlier and providing diagnostic assistance or direction to FE. (See pages 49-50.)

- B) MISO's reliability coordinators were using non-real-time data to support real-time "flowgate" monitoring. This prevented MISO from detecting an N-1 security violation in FE's system and from assisting FE in necessary relief actions. (See pages 48 and 63.)
- C) MISO lacked an effective way to identify the location and significance of transmission line breaker operations reported by their Energy Management System (EMS). Such information would have enabled MISO operators to become aware earlier of important line outages. (See page 48.)

- D) PJM and MISO lacked joint procedures or guidelines on when and how to coordinate a security limit violation observed by one of them in the other's area due to a contingency near their common boundary. (See pages 62-63 and 65-66.)

In the chapters that follow, sections that relate to particular causes are denoted with the following symbols:

Cause 1
Inadequate
System
Understanding

Cause 2
Inadequate
Situational
Awareness

Cause 3
Inadequate
Tree
Trimming

Cause 4
Inadequate
RC Diagnostic
Support

- ◆ NERC is lacking a well-defined control area (CA) audit process that addresses all CA responsibilities. Control area audits have generally not been conducted with sufficient regularity and have not included a comprehensive audit of the control area's compliance with all NERC and Regional Council requirements. Compliance with audit results is not mandatory.
- ◆ ECAR did not conduct adequate review or analyses of FE's voltage criteria, reactive power management practices, and operating needs.
- ◆ FE does not have an adequate automatic under-voltage load-shedding program in the Cleveland-Akron area.

Group 2: Inadequate situational awareness at FirstEnergy. FE did not recognize or understand the deteriorating condition of its system.

Violations (Identified by NERC):

- ◆ **Violation 7:** FE's operational monitoring equipment was not adequate to alert FE's operators regarding important deviations in operating conditions and the need for corrective action as required by NERC Policy 4, Section A, Requirement 5.
- ◆ **Violation 3:** FE's state estimation and contingency analysis tools were not used to assess system conditions, violating NERC Operating Policy 5, Section C, Requirement 3, and Policy 4, Section A, Requirement 5.

Other Problems:

- ◆ FE personnel did not ensure that their Real-Time Contingency Analysis (RTCA) was a functional and effective EMS application as required by NERC Policy 2, Section A, Requirement 1.
- ◆ FE's operational monitoring equipment was not adequate to provide a means for its operators to evaluate the effects of the loss of significant transmission or generation facilities as required by NERC Policy 4, Section A, Requirement 4.
- ◆ FE's operations personnel were not provided sufficient operations information and analysis tools as required by NERC Policy 5, Section C, Requirement 3.
- ◆ FE's operations personnel were not adequately trained to maintain reliable operation under emergency conditions as required by NERC Policy 8, Section 1.
- ◆ NERC Policy 4 has no detailed requirements for: (a) monitoring and functional testing of critical EMS and supervisory control and data acquisition (SCADA) systems, and (b) contingency analysis.
- ◆ NERC Policy 6 includes a requirement to plan for loss of the primary control center, but lacks specific provisions concerning what must be addressed in the plan.
- ◆ NERC system operator certification tests for basic operational and policy knowledge.

Significant additional training is needed to qualify an individual to perform system operation and management functions.

Group 3: FE failed to manage adequately tree growth in its transmission rights-of-way. This failure was the common cause of the outage of three FE 345-kV transmission lines and affected several 138-kV lines.

- ◆ FE failed to maintain equipment ratings through a vegetation management program. A vegetation management program is necessary to fulfill NERC Policy 2, Section A, Requirement 1 (Control areas shall develop, maintain, and implement formal policies and procedures to provide for transmission security . . . including equipment ratings.)
- ◆ Vegetation management requirements are not defined in NERC Standards and Policies.

Group 4: Failure of the interconnected grid's reliability organizations to provide effective diagnostic support.

Violations (Identified by NERC):

- ◆ **Violation 4:** MISO did not notify other reliability coordinators of potential system problems as required by NERC Policy 9, Section C, Requirement 2.
- ◆ **Violation 5:** MISO was using non-real-time data to support real-time operations, in violation of NERC Policy 9, Appendix D, Section A, Criteria 5.2.
- ◆ **Violation 6:** PJM and MISO as reliability coordinators lacked procedures or guidelines between their respective organizations regarding the coordination of actions to address an operating security limit violation observed by one of them in the other's area due to a contingency near their common boundary, as required by Policy 9, Appendix C. **Note:** Policy 9 lacks specifics on what constitutes coordinated procedures and training.

Other Problems:

- ◆ MISO did not have adequate monitoring capability to fulfill its reliability coordinator responsibilities as required by NERC Policy 9, Appendix D, Section A.
- ◆ Although MISO is the reliability coordinator for FE, on August 14 FE was not a signatory to the

MISO Transmission Owners Agreement and was not under the MISO tariff, so MISO did not have the necessary authority as FE's Reliability Coordinator as required by NERC Policy 9, Section B, Requirement 2.

- ◆ Although lacking authority under a signed agreement, MISO as reliability coordinator nevertheless should have issued directives to FE to return system operation to a safe and reliable level as required by NERC Policy 9, Section B, Requirement 2, before the cascading outages occurred.
- ◆ American Electric Power (AEP) and PJM attempted to use the transmission loading relief (TLR) process to address transmission power flows without recognizing that a TLR would not solve the problem.
- ◆ NERC Policy 9 does not contain a requirement for reliability coordinators equivalent to the NERC Policy 2 statement that monitoring equipment is to be used in a manner that would bring to the reliability coordinator's attention any important deviations in operating conditions.
- ◆ NERC Policy 9 lacks criteria for determining the critical facilities lists in each reliability coordinator area.
- ◆ NERC Policy 9 lacks specifics on coordinated procedures and training for reliability coordinators regarding "operating to the most conservative limit" in situations when operating conditions are not fully understood.

Failures to act by FirstEnergy or others to solve the growing problem, due to the other causes.

Violations (Identified by NERC):

- ◆ **Violation 1:** Following the outage of the Chamberlin-Harding 345-kV line, FE operating personnel did not take the necessary action to return the system to a safe operating state as required by NERC Policy 2, Section A, Standard 1.
- ◆ **Violation 2:** FE operations personnel did not adequately communicate its emergency operating conditions to neighboring systems as required by NERC Policy 5, Section A.

Other Problems:

- ◆ FE operations personnel did not promptly take action as required by NERC Policy 5, General

Criteria, to relieve the abnormal conditions resulting from the outage of the Harding-Chamberlin 345-kV line.

- ◆ FE operations personnel did not implement measures to return system operation to within security limits in the prescribed time frame of NERC Policy 2, Section A, Standard 2, following the outage of the Harding-Chamberlin 345-kV line.
- ◆ FE operations personnel did not exercise the authority to alleviate the operating security limit violation as required by NERC Policy 5, Section C, Requirement 2.
- ◆ FE did not exercise a load reduction program to relieve the critical system operating conditions as required by NERC Policy 2, Section A, Requirement 1.2.
- ◆ FE did not demonstrate the application of effective emergency operating procedures as required by NERC Policy 6, Section B, Emergency Operations Criteria.
- ◆ FE operations personnel did not demonstrate that FE has an effective manual load shedding program designed to address voltage decays that result in uncontrolled failure of components of the interconnection as required by NERC Policy 5, General Criteria.
- ◆ NERC Policy 5 lacks specifics for Control Areas on procedures for coordinating with other systems and training regarding “operating to the most conservative limit” in situations when operating conditions are not fully understood.

Institutional Issues

As indicated above, the investigation team identified a number of institutional issues with respect to NERC’s reliability standards. Many of the institutional problems arise not because NERC is an inadequate or ineffective organization, but rather because it has no structural independence from the industry it represents and has no authority to develop strong reliability standards and to enforce compliance with those standards. While many in the industry and at NERC support such measures, legislative action by the U.S. Congress is needed to make this happen.

These institutional issues can be summed up generally:

1. Although NERC’s provisions address many of the factors and practices which contributed to the blackout, some of the policies or guidelines are inexact, non-specific, or lacking in detail, allowing divergent interpretations among reliability councils, control areas, and reliability coordinators. NERC standards are minimum requirements that may be made more stringent if appropriate by regional or subregional bodies, but the regions have varied in their willingness to implement exacting reliability standards.
2. NERC and the industry’s reliability community were aware of the lack of specificity and detail in some standards, including definitions of Operating Security Limits, definition of planned outages, and delegation of Reliability Coordinator functions to control areas, but they moved slowly to address these problems effectively.
3. Some standards relating to the blackout’s causes lack specificity and measurable compliance criteria, including those pertaining to operator training, back-up control facilities, procedures to operate when part or all of the EMS fails, emergency procedure training, system restoration plans, reactive reserve requirements, line ratings, and vegetation management.
4. The NERC compliance program and region-based auditing process has not been comprehensive or aggressive enough to assess the capability of all control areas to direct the operation of their portions of the bulk power system. The effectiveness and thoroughness of regional councils’ efforts to audit for compliance with reliability requirements have varied significantly from region to region. Equally important, absent mandatory compliance and penalty authority, there is no requirement that an entity found to be deficient in an audit must remedy the deficiency.
5. NERC standards are frequently administrative and technical rather than results-oriented.
6. A recently-adopted NERC process for development of standards is lengthy and not yet fully understood or applied by many industry participants. Whether this process can be adapted to support an expedited development of clear and auditable standards for key topics remains to be seen.

7. NERC has not had an effective process to ensure that recommendations made in various reports and disturbance analyses are tracked for accountability. On their own initiative, some regional councils have developed effective tracking procedures for their geographic areas.

Control areas and reliability coordinators operate the grid every day under guidelines, policies, and requirements established by the industry's reliability community under NERC's coordination. If those policies are strong, clear, and unambiguous, then everyone will plan and operate the system at a high level of performance and reliability will be high. But if those policies are ambiguous and do not make entities' roles and responsibilities clear and certain, they allow companies to perform at varying levels and system reliability is likely to be compromised.

Given that NERC has been a voluntary organization that makes decisions based on member votes, if NERC's standards have been unclear, non-specific, lacking in scope, or insufficiently strict, that reflects at least as much on the industry community that drafts and votes on the standards as it does on NERC. Similarly, NERC's ability to obtain compliance with its requirements through its audit process has been limited by the extent to which the industry has been willing to support the audit program.

Endnotes

¹ *Webster's II New Riverside University Dictionary*, Riverside Publishing Co., 1984.

² A NERC team looked at whether and how violations of NERC's reliability requirements may have occurred in the events leading up to the blackout. They also looked at whether deficiencies in the requirements, practices and procedures of NERC and the regional reliability organizations may have contributed to the blackout. They found seven specific violations of NERC operating policies (although some are qualified by a lack of specificity in the NERC requirements).

The Standards, Procedures and Compliance Investigation Team reviewed the NERC Policies for violations, building on work and going beyond work done by the Root Cause Analysis Team. Based on that review the Standards team identified a number of violations related to policies 2, 4, 5, and 9.

Violation 1: Following the outage of the Chamberlin-Harding 345-kV line, FE did not take the necessary actions to return the system to a safe operating state within 30 minutes.

(While Policy 5 on Emergency Operations does not address the issue of "operating to the most conservative limit" when coordinating with other systems and operating conditions are not understood, other NERC policies do address this matter: Policy 2, Section A, Standard 1, on basic reliability for single contingencies; Policy 2, Section A, Standard 2, to return a system to within operating security limits within 30 minutes; Policy 2, Section A, Requirement 1, for formal policies and procedures to provide for transmission security; Policy 5, General Criteria, to relieve any abnormal conditions that jeopardize reliable operation; Policy 5, Section C, Requirement 1, to relieve security limit violations; and Policy 5, Section 2, Requirement 2, which gives system operators responsibility and authority to alleviate operating security limit violations using timely and appropriate actions.)

Violation 2: FE did not notify other systems of an impending system emergency. (Policy 5, Section A, Requirement 1, directs a system to inform other systems if it is burdening others, reducing system reliability, or if its lack of single contingency coverage could threaten interconnection reliability. Policy 5, Section A, Criteria, has similar provisions.)

Violation 3: FE's state estimation/contingency analysis tools were not used to assess the system conditions. (This is addressed in Operating Policy 5, Section C, Requirement 3, concerning assessment of Operating Security Limit violations, and Policy 4, Section A, Requirement 5, which addresses using monitoring equipment to inform the system operator of important conditions and the potential need for corrective action.)

Violation 4: MISO did not notify other reliability coordinators of potential problems. (Policy 9, Section C, Requirement 2, directing the reliability coordinator to alert all control areas and reliability coordinators of a potential transmission problem.)

Violation 5: MISO was using non-real-time data to support real-time operations. (Policy 9, Appendix D, Section A, Criteria For Reliability Coordinators 5.2, regarding adequate facilities to perform their responsibilities, including detailed monitoring capability to identify potential security violations.)

Violation 6: PJM and MISO as Reliability Coordinators lacked procedures or guidelines between themselves on when and how to coordinate an operating security limit violation observed by one of them in the other's area due to a contingency near their common boundary (Policy 9, Appendix 9C, Emergency Procedures). **Note:** Since Policy 9 lacks specifics on coordinated procedures and training, it was not possible for the bi-national team to identify the exact violation that occurred.

Violation 7: The monitoring equipment provided to FE operators was not sufficient to bring the operators' attention to the deviation on the system. (Policy 4, Section A, System Monitoring Requirements regarding resource availability and the use of monitoring equipment to alert operators to the need for corrective action.)

³ NERC has not yet completed its review of planning standards and violations.

4. Context and Preconditions for the Blackout: The Northeastern Power Grid Before the Blackout Began

Summary

This chapter reviews the state of the northeast portion of the Eastern Interconnection during the days and hours before 16:00 EDT on August 14, 2003, to determine whether grid conditions before the blackout were in some way unusual and might have contributed to the initiation of the blackout. Task Force investigators found that at 15:05 Eastern Daylight Time, immediately before the tripping (automatic shutdown) of FirstEnergy’s (FE) Harding-Chamberlin 345-kV transmission line, the system was electrically secure and was able to withstand the occurrence of any one of more than 800 contingencies, including the loss of the Harding-Chamberlin line. At that time the system was electrically within prescribed limits and in compliance with NERC’s operating policies.

Determining that the system was in a reliable operational state at 15:05 EDT on August 14, 2003, is extremely significant for determining the causes of the blackout. It means that none of the electrical conditions on the system before 15:05 EDT was a direct cause of the blackout. This eliminates a number of possible causes of the blackout, whether individually or in combination with one another, such as:

- ◆ Unavailability of individual generators or transmission lines
- ◆ High power flows across the region
- ◆ Low voltages earlier in the day or on prior days
- ◆ System frequency variations
- ◆ Low reactive power output from independent power producers (IPPs).

This chapter documents that although the system was electrically secure, there was clear experience and evidence that the Cleveland-Akron area was highly vulnerable to voltage instability problems. While it was possible to operate the system

securely despite those vulnerabilities, FirstEnergy was not doing so because the company had not conducted the long-term and operational planning studies needed to understand those vulnerabilities and their operational implications.

It is important to emphasize that establishing whether conditions were normal or unusual prior to and on August 14 does not change the responsibilities and actions expected of the organizations and operators charged with ensuring power system reliability. As described in Chapter 2, the electricity industry has developed and codified a set of mutually reinforcing reliability standards and practices to ensure that system operators are prepared for the unexpected. The basic assumption underlying these standards and practices is that power system elements will fail or become unavailable in unpredictable ways and at

Reliability and Security

NERC—and this report—use the following definitions for reliability, adequacy, and security.

Reliability: The degree of performance of the elements of the bulk electric system that results in electricity being delivered to customers within accepted standards and in the amount desired. Reliability may be measured by the frequency, duration, and magnitude of adverse effects on the electricity supply.

Adequacy: The ability of the electric system to supply the aggregate electrical demand and energy requirements of the customers at all times, taking into account scheduled and reasonably expected unscheduled outages of system elements.

Security: The ability of the electric system to withstand sudden disturbances such as electric short circuits or unanticipated loss of system elements.

unpredictable times. Sound reliability management is designed to ensure that operators can continue to operate the system within appropriate thermal, voltage, and stability limits following the unexpected loss of any key element (such as a major generator or key transmission facility). These practices have been designed to maintain a functional and reliable grid, regardless of whether actual operating conditions are normal.

It is a basic principle of reliability management that “operators must operate the system they have in front of them”—unconditionally. The system must be operated at all times to withstand any single contingency and yet be ready within 30 minutes for the next contingency. If a facility is lost unexpectedly, the system operators must determine whether to make operational changes, including adjusting generator outputs, curtailing

Geography Lesson

In analyzing the August 14 blackout, it is crucial to understand the geography of the FirstEnergy area. FirstEnergy has seven subsidiary distribution utilities: Toledo Edison, Ohio Edison, and The Illuminating Company in Ohio and four more in Pennsylvania and New Jersey. Its Ohio control area spans the three Ohio distribution utility footprints and that of Cleveland Public Power, a municipal utility serving the city of Cleveland. Within FE’s Ohio control area is the Cleveland-Akron area, shown in red cross-hatch.

This geographic distinction matters because the Cleveland-Akron area is a transmission-constrained load pocket with relatively limited generation. While some analyses of the blackout refer to voltages and other indicators measured at the boundaries of FE’s Ohio control area, those indicators have limited relevance to the blackout—the indicators of conditions at the edges of and within the Cleveland-Akron area are the ones that matter.

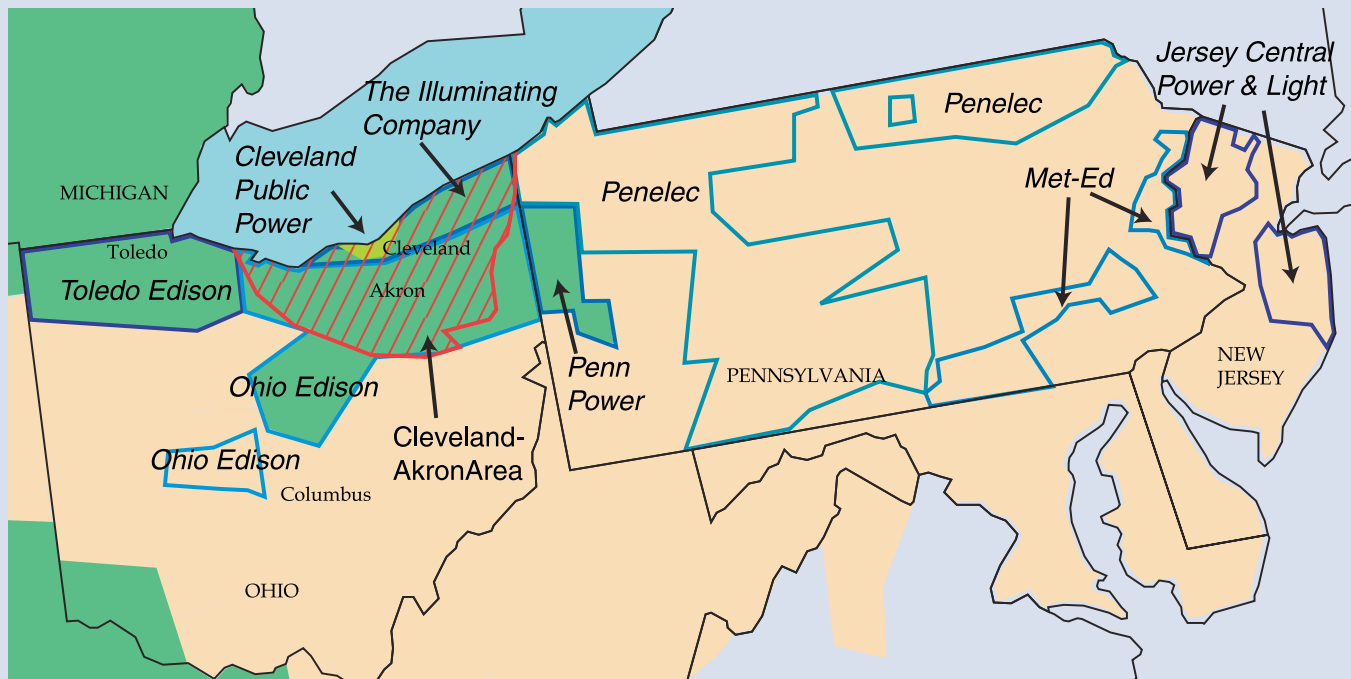

Area	All-Time Peak Load (MW)	Load on August 14, 2003 (MW)
Cleveland-Akron Area (including Cleveland Public Power)	7,340	6,715
FirstEnergy Control Area, Ohio	13,299	12,165
FirstEnergy Retail Area, including PJM	24,267	22,631

NA = not applicable.

electricity transactions, taking transmission elements out of service or restoring them, and if necessary, shedding interruptible and firm customer load—i.e., cutting some customers off temporarily, and in the right locations, to reduce electricity demand to a level that matches what the system is then able to deliver safely.

This chapter discusses system conditions in and around northeast Ohio on August 14 and their relevance to the blackout. It reviews electric loads (real and reactive), system topology (transmission and generation equipment availability and capabilities), power flows, voltage profiles and reactive power reserves. The discussion examines actual system data, investigation team modeling results, and past FE and AEP experiences in the Cleveland-Akron area. The detailed analyses will be presented in a NERC technical report.

Electric Demands on August 14

Temperatures on August 14 were hot but in a normal range throughout the northeast region of the United States and in eastern Canada (Figure 4.1). Electricity demands were high due to high air conditioning loads typical of warm days in August, though not unusually so. As the temperature increased from 78°F (26°C) on August 11 to 87°F (31°C) on August 14, peak load within FirstEnergy’s control area increased by 20%, from 10,095 MW to 12,165 MW. System operators had successfully managed higher demands in northeast Ohio and across the Midwest, both earlier in the summer and in previous years—historic peak load for FE’s control area was 13,299 MW. August 14 was FE’s peak demand day in 2003.

Several large operators in the Midwest consistently under-forecasted load levels between

August 11 and 14. Figure 4.2 shows forecast and actual power demands for AEP, Michigan Electrical Coordinated Systems (MECS), and FE from August 11 through August 14. Variances between actual and forecast loads are not unusual, but because those forecasts are used for day-ahead planning for generation, purchases, and reactive power management, they can affect equipment availability and schedules for the following day.

The existence of high air conditioning loads across the Midwest on August 14 is relevant because air conditioning loads (like other induction motors) have lower power factors than other customer electricity uses, and consume more reactive power. Because it had been hot for several days in the Cleveland-Akron area, more air conditioners were running to overcome the persistent heat, and consuming relatively high levels of reactive power—further straining the area’s limited reactive generation capabilities.

Generation Facilities Unavailable on August 14

Several key generators in the region were out of service going into the day of August 14. On any given day, some generation and transmission capacity is unavailable; some facilities are out for routine maintenance, and others have been forced out by an unanticipated breakdown and require repairs. August 14, 2003, in northeast Ohio was no exception (Table 4.1).

The generating units that were not available on August 14 provide real and reactive power directly to the Cleveland, Toledo, and Detroit areas. Under standard practice, system operators take into account the unavailability of such units and any

Figure 4.1. August 2003 Temperatures in the U.S. Northeast and Eastern Canada

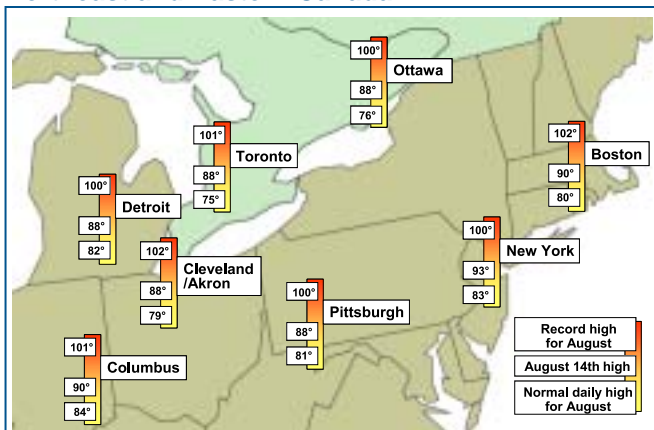
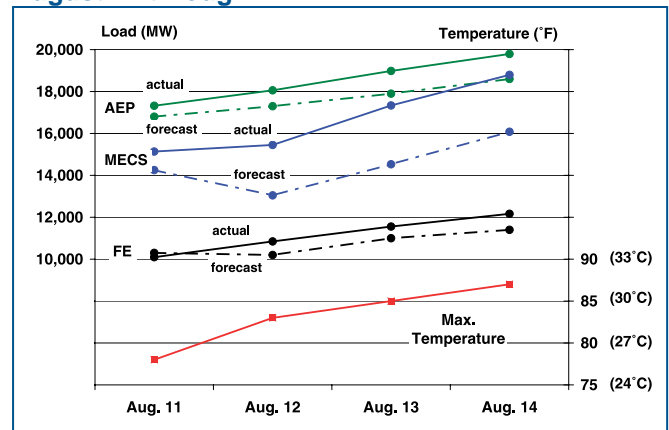

Figure 4.2. Load Forecasts Below Actuals, August 11 through 14



transmission facilities known to be out of service in the day-ahead planning studies they perform to ensure a secure system for the next day. Knowing the status of key facilities also helps operators determine in advance the safe electricity transfer levels for the coming day.

MISO’s day-ahead planning studies for August 14 took the above generator outages and transmission outages reported to MISO into account and

determined that the regional system could be operated safely. The unavailability of these generation units did not cause the blackout.

On August 14 four or five capacitor banks within the Cleveland-Akron area had been removed from service for routine inspection, including capacitor banks at Fox and Avon 138-kV substations.¹ These static reactive power sources are important for voltage support, but were not restored to

Table 4.1. Generators Not Available on August 14

Generator	Rating	Reason
Davis-Besse Nuclear Unit	883 MW	Prolonged NRC-ordered outage beginning on 3/22/02
Sammis Unit 3	180 MW	Forced outage on 8/12/03
Eastlake Unit 4	238 MW	Forced outage on 8/13/03
Monroe Unit 1	817 MW	Planned outage, taken out of service on 8/8/03
Cook Nuclear Unit 2	1,060 MW	Outage began on 8/13/03

Load Power Factors and Reactive Power

Load power factor is a measure of the relative magnitudes of real power and reactive power consumed by the load connected to a power system. Resistive load, such as electric space heaters or incandescent lights, consumes only real power and no reactive power and has a load power factor of 1.0. Induction motors, which are widely used in manufacturing processes, mining, and homes (e.g., air-conditioners, fan motors in forced-air furnaces, and washing machines) consume both real power and reactive power. Their load power factors are typically in the range of 0.7 to 0.9 during steady-state operation. Single-phase small induction motors (e.g., household items) generally have load power factors in the lower range.

The lower the load power factor, the more reactive power is consumed by the load. For example, a 100 MW load with a load power factor of 0.92 consumes 43 MVar of reactive power, while the same 100 MW of load with a load power factor of 0.88 consumes 54 MVar of reactive power. Under depressed voltage conditions, the induction motors used in air-conditioning units and refrigerators, which are used more heavily on hot and humid days, draw even more reactive power than under normal voltage conditions.

In addition to end-user loads, transmission elements such as transformers and transmission lines consume reactive power. Reactive power compensation is required at various locations in the network to support the transmission of real

power. Reactive power is consumed within transmission lines in proportion to the square of the electric current shipped, so a 10% increase of power transfer will require a 21% increase in reactive power generation to support the power transfer.

In metropolitan areas with summer peaking loads, it is generally recognized that as temperatures and humidity increase, load demand increases significantly. The power factor impact can be quite large—for example, for a metropolitan area of 5 million people, the shift from winter peak to summer peak demand can shift peak load from 9,200 MW in winter to 10,000 MW in summer; that change to summer electric loads can shift the load power factor from 0.92 in winter down to 0.88 in summer; and this will increase the MVar load demand from 3,950 in winter up to 5,400 in summer—all due to the changed composition of end uses and the load factor influences noted above.

Reactive power does not travel far, especially under heavy load conditions, and so must be generated close to its point of consumption. This is why urban load centers with summer peaking loads are generally more susceptible to voltage instability than those with winter peaking loads. Thus, control areas must continually monitor and evaluate system conditions, examining reactive reserves and voltages, and adjust the system as necessary for secure operation.

service that afternoon despite the system operators' need for more reactive power in the area.² Normal utility practice is to inspect and maintain reactive resources in off-peak seasons so the facilities will be fully available to meet peak loads.

Cause 1
Inadequate System Understanding

The unavailability of the critical reactive resources was not known to those outside of FirstEnergy. NERC policy requires that critical facilities be identified and that neighboring control areas and reliability coordinators be made aware of the status of those facilities to identify the impact of those conditions on their own facilities. However, FE never identified these capacitor banks as critical and so did not pass on status information to others.

Recommendations
23, page 160; 30, page 163

Recommendation
30, page 163

Unanticipated Outages of Transmission and Generation on August 14

Three notable unplanned outages occurred in Ohio and Indiana on August 14 before 15:05 EDT. Around noon, several Cinergy transmission lines in south-central Indiana tripped; at 13:31 EDT, FE's Eastlake 5 generating unit along the southwestern shore of Lake Erie tripped; at 14:02 EDT, a line within the Dayton Power and Light (DPL) control area, the Stuart-Atlanta 345-kV line in southern Ohio, tripped. Only the Eastlake 5 trip was electrically significant to the FirstEnergy system.

- ◆ Transmission lines on the Cinergy 345-, 230-, and 138-kV systems experienced a series of outages starting at 12:08 EDT and remained out of service during the entire blackout. The loss of these lines caused significant voltage and loading problems in the Cinergy area. Cinergy made generation changes, and MISO operators responded by implementing transmission loading relief (TLR) procedures to control flows on the transmission system in south-central Indiana. System modeling by the investigation team (see details below, pages 41-43) showed that the loss of these lines was not electrically related to subsequent events in northern Ohio that led to the blackout.
- ◆ The Stuart-Atlanta 345-kV line, operated by DPL, and monitored by the PJM reliability coordinator, tripped at 14:02 EDT. This was the result of a tree contact, and the line remained out of service the entire afternoon. As explained below, system modeling by the investigation

team has shown that this outage did not cause the subsequent events in northern Ohio that led to the blackout. However, since the line was not in MISO's footprint, MISO operators did not monitor the status of this line and did not know it had gone out of service. This led to a data mismatch that prevented MISO's state estimator (a key monitoring tool) from producing usable results later in the day at a time when system conditions in FE's control area were deteriorating (see details below, pages 46 and 48-49).

- ◆ Eastlake Unit 5 is a 597 MW (net) generating unit located west of Cleveland on Lake Erie. It is a major source of reactive power support for the Cleveland area. It tripped at 13:31 EDT. The cause of the trip was that as the Eastlake 5 operator sought to increase the unit's reactive power output (Figure 4.3), the unit's protection system detected that VAR output exceeded the unit's VAR capability and tripped the unit off-line. The loss of the Eastlake 5 unit did not put the grid into an unreliable state—i.e., it was still able to withstand safely another contingency. However, the loss of the unit required FE to import additional power to make up for the loss of the unit's output (612 MW), made voltage management in northern Ohio more challenging, and gave FE operators less flexibility in operating their system (see details on pages 45-46 and 49-50).

Key Parameters for the Cleveland-Akron Area at 15:05 EDT

The investigation team benchmarked their power flow models against measured data provided by

Figure 4.3. MW and MVar Output from Eastlake Unit 5 on August 14

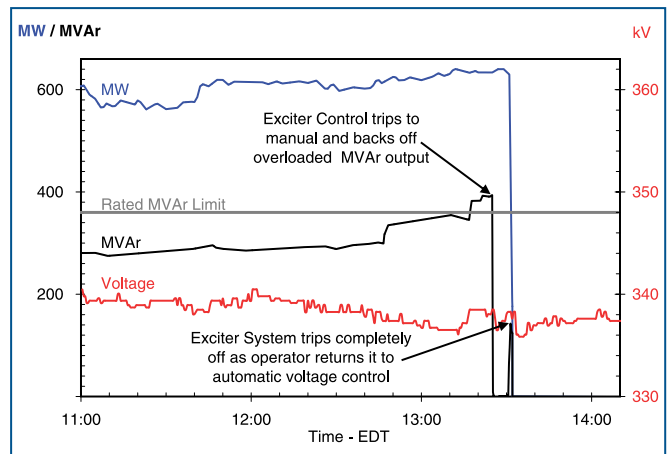

FirstEnergy for the Cleveland-Akron area at 15:05 EDT (just before the first of FirstEnergy’s key transmission lines failed), as shown in Table 4.2. Although the modeled figures do not match actual system conditions perfectly, overall this model shows a very high correspondence to the actual occurrences and thus its results merit a high degree of confidence. Although Table 4.2 shows only a few key lines within the Cleveland-Akron area, the model was successfully benchmarked to match actual flows, line-by-line, very closely across the entire area for the afternoon of August 14, 2003.

The power flow model assumes the following system conditions for the Cleveland-Akron area at 15:05 EDT on August 14:

- ◆ Cleveland-Akron area load = 6,715 MW and 2,402 MVar
- ◆ Transmission losses = 189 MW and 2,514 MVar
- ◆ Reactive power from fixed shunt capacitors (all voltage levels) = 2,585 MVar
- ◆ Reactive power from line charging (all voltage levels) = 739 MVar
- ◆ Network configuration = after the loss of Eastlake 5, before the loss of Harding-Chamberlin 345-kV line
- ◆ Area generation combined output: 3,000 MW and 1,200 MVar.

Cause 1
Inadequate System Understanding

Given these conditions, the power flow model indicates that about 3,900 MW and 400 MVar of real power and reactive power flow into the Cleveland-Akron area

was needed to meet the sum of customer load demanded plus line losses. There was about 688 MVar of reactive reserve from generation in the area, which is slightly more than the 660 MVar reactive capability of the Perry nuclear unit. Combined with the fact that a 5% reduction in operating voltage would cause a 10% reduction in

reactive power (330 MVar) from shunt capacitors and line charging and a 10% increase (250 MVar) in reactive losses from transmission lines, these parameters indicate that the Cleveland-Akron area would be precariously short of reactive power if the Perry plant were lost.

Power Flow Patterns

Several commentators have suggested that the voltage problems in northeast Ohio and the subsequent blackout occurred due to unprecedented high levels of inter-regional power transfers occurring on August 14. Investigation team analysis indicates that in fact, power transfer levels were high but were within established limits and previously experienced levels. Analysis of actual and test case power flows demonstrates that inter-regional power transfers had a minimal effect on the transmission corridor containing the Harding-Chamberlin, Hanna-Juniper, and Star-South Canton 345-kV lines on August 14. It was the increasing native load relative to the limited amount of reactive power available in the Cleveland-Akron area that caused the depletion of reactive power reserves and declining voltages.

On August 14, the flow of power through the ECAR region as a whole (lower Michigan, Indiana, Ohio, Kentucky, West Virginia, and western Pennsylvania) was heavy as a result of transfers of power from the south (Tennessee, etc.) and west (Wisconsin, Minnesota, Illinois, Missouri, etc.) to the north (Ohio, Michigan, and Ontario) and east (New York, Pennsylvania). The destinations for much of the power were northern Ohio, Michigan, PJM, and Ontario. This is shown in Figure 4.4, which shows the flows between control areas on August 14 based on power flow simulations just before the Harding-Chamberlin line tripped at 15:05 EDT. FE’s total load peaked at 12,165MW at 16:00 EDT. Actual system data indicate that between 15:00 and 16:00 EDT, actual line flows into FE’s control area were 2,695 MW for both transactions and native load.

Table 4.2. Benchmarking Model Results to Actual

FE Circuit		MVA Comparison		Benchmark Accuracy
From	To	Model Base Case MVA	Actual 8/14 MVA	
Chamberlin	Harding	482	500	3.6%
Hanna	Juniper	1,009	1,007	0.2%
S. Canton	Star	808	810	0.2%
Tidd	Canton Central	633	638	0.8%
Sammis	Star	728	748	2.7%

Figure 4.4. Generation, Demand, and Interregional Power Flows on August 14, 2003, at 15:05 EDT

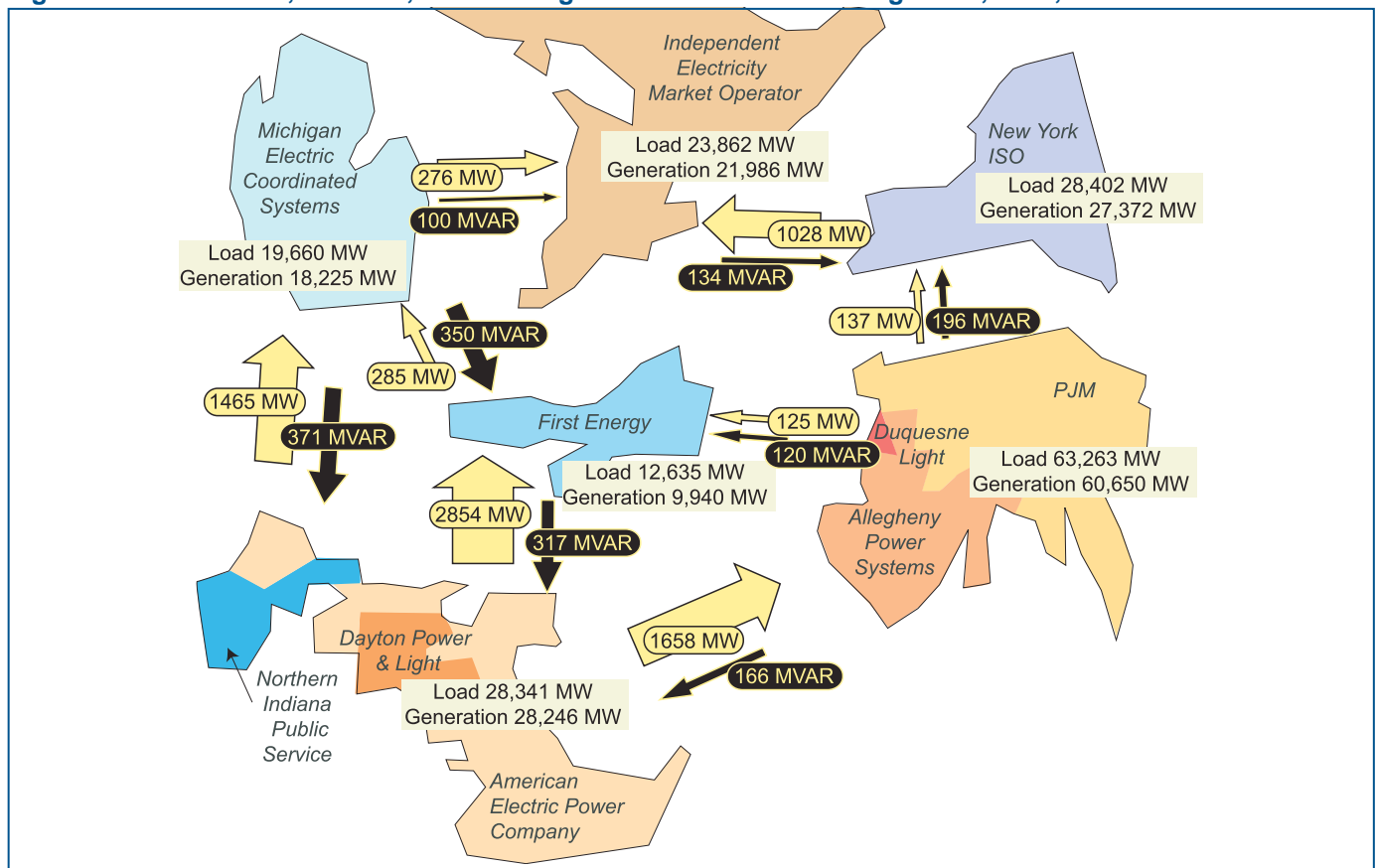
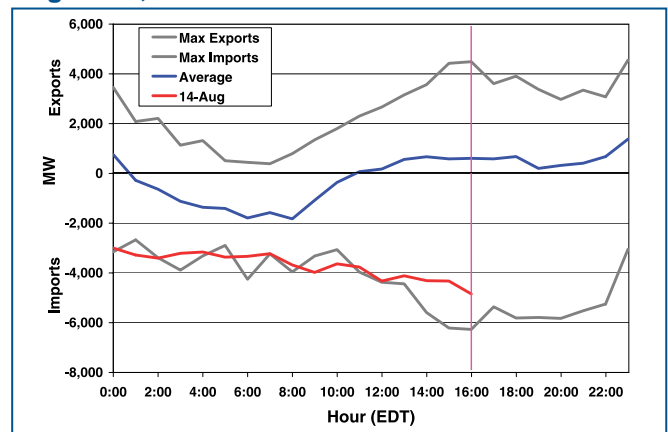

Figure 4.5 shows total scheduled imports for the entire northeast region for June through August 14, 2003. These transfers were well within the range of previous levels, as shown in Figure 4.5, and well within all established limits. In particular, on August 14 increasing amounts of the growing imports into the area were being delivered to FirstEnergy’s Ohio territory to meet its increasing demand and to replace the generation lost with the trip of Eastlake 5. The level of imports into Ontario from the U.S. on August 14 was high (e.g., 1,334 MW at 16:00 EDT through the New York and Michigan ties) but not unusual, and well within IMO’s import capability. Ontario is a frequent importer and exporter of power, and had imported similar and higher amounts of power several times during the summers of 2002 and 2003. PJM and Michigan also routinely import and export power across ECAR.

Some have suggested that the level of power flows into and across the Midwest was a direct cause of the blackout on August 14. Investigation team modeling proves that these flows were neither a cause nor a contributing factor to the blackout. The team used detailed modeling and simulation incorporating the NERC TagNet data on actual

Figure 4.5. Scheduled Imports and Exports for the Northeast Central Region, June 1 through August 13, 2003



Note: These flows from within the Northeast Central Area include ECAR, PJM, IMO, NYISO, and exclude transfers from Québec, the Maritimes and New England, since the latter areas had minimal flows across the region of interest.

transactions to determine whether and how the transactions affected line loadings within the Cleveland-Akron area. The MUST (Managing Utilization of System Transmission) analytical tool uses the transactions data from TagNet along with a power flow program to determine the impact of transactions on the loading of transmission

flowgates or specific facilities, calculating transfer distribution factors across the various flowgates. The MUST analysis shows that for actual flows at 15:05 EDT, only 10% of the loading on Cleveland-Akron lines was for through flows for which FE was neither the importer nor exporter.

According to real-time TagNet records, at 15:05 EDT the incremental flows due to transactions were approximately 2,800 MW flowing into the FirstEnergy control area and approximately 800 MW out of FE to Duquesne Light Company (DLCO). Among the flows into or out of the FE control area, the bulk of the flows were for transactions where FE was the recipient or the source—at 15:05 EDT the incremental flows due to transactions into FE were 1,300 MW from interconnections with PJM, AEP, DPL and MECS, and approximately 800 MW from interconnections with DLCO. But not all of that energy moved through the Cleveland-Akron area and across the lines which failed on August 14, as Figure 4.6 shows.

Figure 4.6 shows how all of the transactions flowing across the Cleveland-Akron area on the afternoon of August 14 affected line loadings at key FE facilities, organized by time and types of transactions. It shows that before the first transmission line failed, the bulk of the loading on the four critical FirstEnergy circuits—Harding-Chamberlin, Hanna-Juniper, Star-South Canton and Sammis-Star—was to serve Cleveland-Akron area native load. Flows to serve native load included transfers from FE’s 1,640 MW Beaver Valley nuclear power plant and its Seneca plant, both in Pennsylvania, which have been traditionally counted by FirstEnergy not as imports but rather as in-area

Figure 4.6. Impacts of Transactions Flows on Critical Line Loadings, August 14, 2003

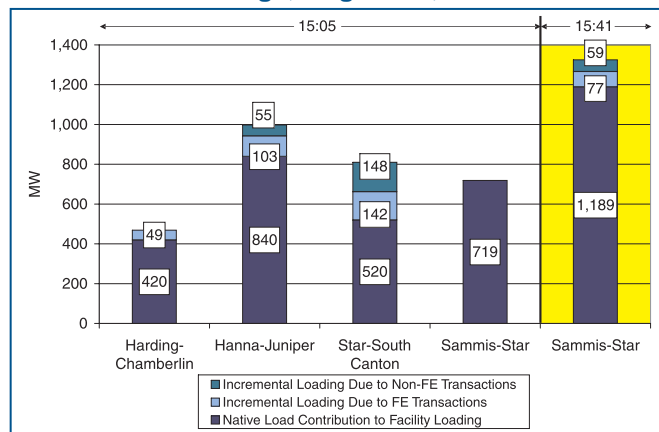

generation, and as such excluded from TLR curtailments. An additional small increment of line loading served transactions for which FE was either the importer or exporter, and the remaining line loading was due to through-flows initiated and received by other entities. The Star-South Canton line experienced the greatest impact from through-flows—148 MW, or 18% of the total line loading at 15:05 EDT, was due to through-flows resulting from non-FE transactions. By 15:41 EDT, right before Star-South Canton tripped—without being overloaded—the Sammis-Star line was serving almost entirely native load, with loading from through-flows down to only 4.5%.

Cause 1
Inadequate System Understanding

The central point of this analysis is that because the critical lines were loaded primarily to serve native load and FE-related flows, attempts to reduce flows through

transaction curtailments in and around the Cleveland-Akron area would have had minimal impact on line loadings and the declining voltage situation within that area. Rising load in the Cleveland-Akron area that afternoon was depleting the remaining reactive power reserves. Since there was no additional in-area generation, only in-area load cuts could have reduced local line loadings and improved voltage security. This is confirmed by the loadings on the Sammis-Star at 15:42 EDT, after the loss of Star-South

Recommendations
3, page 143; 23, page 160

Canton—fully 96% of the current on that line was to serve FE load and FE-related transactions, and a cut of *every non-FE through transaction* flowing across northeast Ohio would have obtained only 59 MW (4%) of relief for this specific line. This means that redispatch of generation beyond northeast Ohio would have had almost no impact upon conditions within the Cleveland-Akron area (which after 13:31 EDT had no remaining generation reserves). Equally important, cutting flows on the Star-South Canton line might not have changed subsequent events—because the line opened three times that afternoon due to tree contacts, reducing its loading would not have assured its continued operation.

Power flow patterns on August 14 did not cause the blackout in the Cleveland-Akron area. But once the first four FirstEnergy lines went down, the magnitude and pattern of flows on the overall system did affect the ultimate path, location and speed of the cascade after 16:05:57 EDT.³

Voltages and Voltage Criteria

During the days before August 14 and throughout the morning and mid-day on August 14, voltages were depressed across parts of northern Ohio because of high air conditioning demand and other loads, and power transfers into and to a lesser extent across the region. Voltage varies by location across an electrical region, and operators monitor voltages continuously at key locations across their systems.

Entities manage voltage using long-term planning and day-ahead planning for adequate reactive supply, and real-time adjustments to operating equipment. On August 14, for example, PJM implemented routine voltage management procedures developed for heavy load conditions. Within Ohio, FE began preparations early in the afternoon of August 14, requesting capacitors to be restored to service⁴ and additional voltage support from generators.⁵ As the day progressed, operators across the region took additional actions, such as increasing plants' reactive power output, plant redispatch, and transformer tap changes to respond to changing voltage conditions.

Voltages at key FirstEnergy buses (points at which lines, generators, transformers, etc., converge)

were declining over the afternoon of August 14. Actual measured voltage levels at the Star bus and others on FE's transmission system on August 14 were below 100% starting early in the day. At 11:00 EDT, voltage at the Star bus equaled 98.5%, declined to 97.3% after the loss of Eastlake 5 at 13:31 EDT, and dropped to 95.9% at 15:05 EDT after the loss of the Harding-Chamberlin line. FirstEnergy system operators reported this voltage performance to be typical for a warm summer day on the FirstEnergy system. The gradual decline of voltage over the early afternoon was consistent with the increase of load over the same time period, particularly given that FirstEnergy had no additional generation within the Cleveland-Akron area load pocket to provide additional reactive support.

Cause 1 Inadequate System Understanding

NERC and regional reliability councils' planning criteria and operating policies (such as NERC I.A and I.D, NPCC A-2, and ECAR Document 1) specify voltage criteria in such generic terms as: acceptable voltages under normal and emergency conditions shall be maintained within normal limits and applicable emergency limits respectively, with due recognition to avoiding voltage instability and widespread system collapse in the event of certain contingencies. Each system then defines its own

Do ATC and TTC Matter for Reliability?

Each transmission provider calculates Available Transfer Capability (ATC) and Total Transfer Capability (TTC) as part of its Open Access Transmission Tariff, and posts those on the OASIS to enable others to plan power purchase transactions. TTC is the forecast amount of electric power that can be transferred over the interconnected transmission network in a reliable manner under specific system conditions. ATCs are forecasts of the amount of transmission available for additional commercial trade above projected committed uses. These are not real-time operating security limits for the grid.

The monthly TTC and ATC values for August 2003 were first determined a year previously; those for August 14, 2003 were calculated 30 days in advance; and the hourly TTC and ATC values for the afternoon of August 14 were calculated approximately seven days ahead using forecasted system conditions. Each of these values should be updated as the forecast of system

conditions changes. Thus the TTC and ATC are advance estimates for commercial purposes and do not directly reflect actual system conditions. NERC's operating procedures are designed to manage actual system conditions, not forecasts such as ATC and TTC.

Within ECAR, ATCs and TTCs are determined on a first contingency basis, assuming that only the most critical system element may be forced out of service during the relevant time period. If actual grid conditions—loads, generation dispatch, transaction requests, and equipment availability—differ from the conditions assumed previously for the ATC and TTC calculation, then the ATC and TTC have little relevance for actual system operations. Regardless of what pre-calculated ATC and TTC levels may be, system operators must use real-time monitoring and contingency analysis to track and respond to real-time facility loadings to assure that the transmission system is operated reliably.

acceptable voltage criteria based on its own system design and equipment characteristics, detailing quantified measures including acceptable minimum and maximum voltages in percentages of nominal voltage and acceptable voltage

declines from the pre-contingency voltage. Good utility practice requires that these determinations be based on a full set of V-Q (voltage performance V relative to reactive power supply Q) and P-V (real power transfer P relative to voltage V)

Competition and Increased Electric Flows

Besides blaming high inter-regional power flows for causing the blackout, some blame the existence of those power flows upon wholesale electric competition. Before 1978, most power plants were owned by vertically-integrated utilities; purchases between utilities occurred when a neighbor had excess power at a price lower than other options. A notable increase in inter-regional power transfers occurred in the mid-1970s after the oil embargo, when eastern utilities with a predominance of high-cost oil-fired generation purchased coal-fired energy from Midwestern generators. The 1970s and 1980s also saw the development of strong north-to-south trade between British Columbia and California in the west, and Ontario, Québec, and New York-New England in the east. Americans benefited from Canada's competitively priced hydroelectricity and nuclear power while both sides gained from seasonal and daily banking and load balancing—Canadian provinces had winter peaking loads while most U.S. utilities had primarily summer peaks.

In the United States, wholesale power sales by independent power producers (IPPs) began after passage of the Public Utility Regulatory Policy Act of 1978, which established the right of non-utility producers to operate and sell their energy to utilities. This led to extensive IPP development in the northeast and west, increasing in-region and inter-regional power sales as utility loads grew without corresponding utility investments in transmission. In 1989, investor-owned utilities purchased 17.8% of their total energy (self-generation plus purchases) from other utilities and IPPs, compared to 37.3% in 2002; and in 1992, large public power entities purchased 36.3% of total energy (self-generation plus purchases), compared to 40.5% in 2002.^a

In the Energy Policy Act of 1992, Congress continued to promote the development of

competitive energy markets by introducing exempt wholesale generators that would compete with utility generation in wholesale electric markets (see Section 32 of the Public Utility Holding Company Act). Congress also broadened the authority of the Federal Energy Regulatory Commission to order transmission access on a case-by-case basis under Section 211 of the Federal Power Act. Consistent with this Congressional action, the Commission in Order 888 ordered all public utilities that own, operate, or control interstate transmission facilities to provide open access for sales of energy transmitted over those lines.

Competition is not the only thing that has grown over the past few decades. Between 1986 and 2002, peak demand across the United States grew by 26%, and U.S. electric generating capacity grew by 22%,^b but U.S. transmission capacity grew little beyond the interconnection of new power plants. Specifically, “the amount of transmission capacity per unit of consumer demand declined during the past two decades and . . . is expected to drop further in the next decade.”^c

Load-serving entities today purchase power for the same reason they did before the advent of competition—to serve their customers with low-cost energy—and the U.S. Department of Energy estimates that Americans save almost \$13 billion (U.S.) annually on the cost of electricity from the opportunity to buy from distant, economical sources. But it is likely that the increased loads and flows across a transmission grid that has experienced little new investment is causing greater “stress upon the hardware, software and human beings that are the critical components of the system.”^d A thorough study of these issues has not been possible as part of the Task Force's investigation, but such a study would be worthwhile. For more discussion, see Recommendation 12, page 148.

^aRDI PowerDat database.

^bU.S. Energy Information Administration, *Energy Annual Data Book*, 2003 edition.

^cDr. Eric Hirst, “Expanding U.S. Transmission Capacity,” August 2000, p. vii.

^dLetter from Michael H. Dworkin, Chairman, State of Vermont Public Service Board, February 11, 2004, to Alison Silverstein and Jimmy Glotfelty.

analyses for a wide range of system conditions. Table 4.3 compares the voltage criteria used by FirstEnergy and other relevant transmission operators in the region. As this table shows, FE uses minimum acceptable normal voltages which are lower than and incompatible with those used by its interconnected neighbors.

Recommendation
23, page 160

Cause 1
Inadequate System Understanding

The investigation team probed deeply into voltage management issues within the Cleveland-Akron area. As noted previously, a power system with higher operating voltage and larger reactive power reserves is more resilient or robust in the face of load increases and operational contingencies. Higher transmission voltages enable higher power transfer capabilities and reduce transmission line losses (both real and reactive). For the Cleveland-Akron area, FE has been operating the system with the minimum voltage level at 90% of nominal rating, with alarms set at 92%.⁶ The criteria allow for a single contingency to occur if voltage remains above 90%. The team conducted extensive voltage stability studies (discussed below), concluding that FE’s 90% minimum voltage level was not only far less stringent than nearby interconnected systems (most of which set the pre-contingency minimum voltage criteria at 95%), but was not adequate for secure system operations.

Examination of the Form 715 filings made by Ohio Edison, FE’s predecessor company, for 1994 through 1997 indicate that Ohio Edison used a pre-contingency bus voltage criteria of 95 to 105 % and 90% emergency post-contingency voltage, with acceptable change in voltage no greater than 5%. These historic criteria were compatible with neighboring transmission operator practices.

A look at voltage levels across the region illustrates the difference between FE’s voltage situation on August 14 and that of its neighbors.

Cause 1
Inadequate System Understanding

Figure 4.7 shows the profile of voltage levels at key buses from southeast Michigan across Ohio into western Pennsylvania from August 11 through 14 and for several hours on August 14. These transects show that across the area, voltage levels were consistently lower at the 345-kV buses in the Cleveland-Akron area (from Beaver to Hanna on the west to east plot and from Avon Lake to Star on the north to south plot) for the three days and the 13:00 to 15:00 EDT period preceding the blackout. Voltage was consistently and considerably higher at the outer ends of each transect, where it never dropped below 96% even on August 14. These profiles also show clearly the decline of voltage over the afternoon of August 14, with voltage at the Harding bus at 15:00 EDT just below 96% before the Harding-Chamberlin line tripped at 15:05 EDT, and dropping down to around 93% at 16:00 EDT after the loss of lines and load in the immediate area.

Cause 1
Inadequate System Understanding

Using actual data provided by FE, ITC, AEP and PJM, Figure 4.8 shows the availability of reactive reserves (the difference between reactive power generated and the maximum reactive capability) within the Cleveland-Akron area and four regions surrounding it, from ITC to PJM. On the afternoon of August 14, the graph shows that reactive power generation was heavily taxed in the Cleveland-Akron area but that extensive MVAR reserves were available in the neighboring areas. As the afternoon progressed, reactive reserves diminished for all five regions as load grew. But reactive reserves were fully depleted within the Cleveland-Akron area by 16:00 EDT without drawing down the reserves in neighboring areas, which remained at scheduled voltages. The region as a whole had sufficient reactive reserves, but because reactive power cannot be transported far but must be supplied from

Table 4.3. Comparison of Voltage Criteria (Percent)

345 kV/138 kV	FE	PJM	AEP	METC ^a	ITC ^b	MISO	IMO ^c
High	105	105	105	105	105	105	110
Normal Low	90	95	95	97	95	95	98
Emergency/Post N-1 Low	90	92	90 ^d		87		94
Maximum N-1 deviation	5 ^e			5			10

^aApplies to 138 kV only. 345 kV not specified.
^bApplies to 345 kV only. Min-max normal voltage for 120 kV and 230 kV is 93-105%.
^c500 kV.
^d92% for 138 kV.
^e10% for 138 kV.

Figure 4.7. Actual Voltages Across the Ohio Area Before and On August 14, 2003

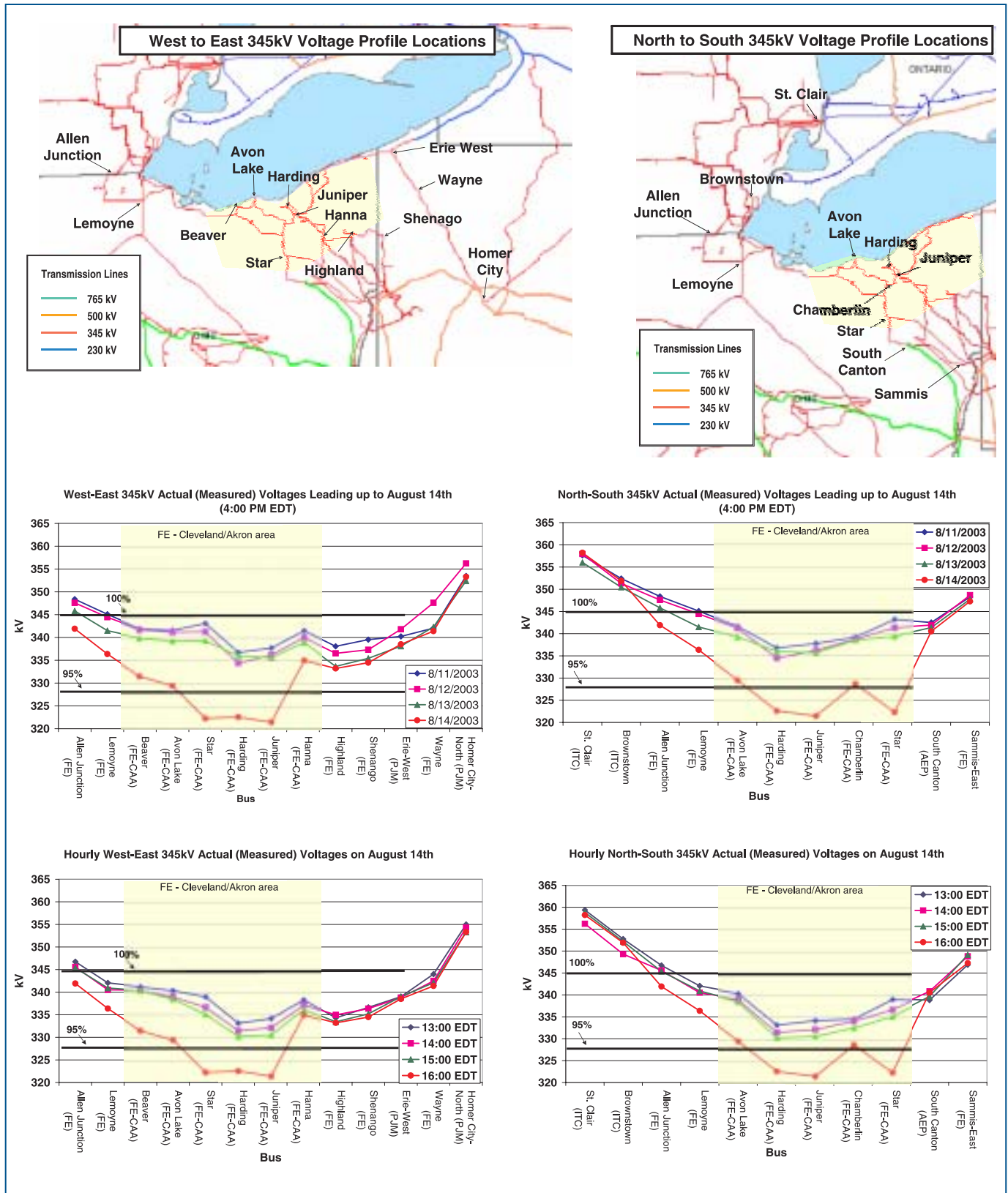

Voltage Stability Analysis

Voltage instability or voltage collapse occurs on a power system when voltages progressively decline until stable operating voltages can no longer be maintained. This is precipitated by an imbalance of reactive power supply and demand, resulting from one or more changes in system conditions including increased real or reactive loads, high power transfers, or the loss of generation or transmission facilities. Unlike the phenomenon of transient instability, where generators swing out of synchronism with the rest of the power system within a few seconds or less after a critical fault, voltage instability can occur gradually within tens of seconds or minutes.

Voltage instability is best studied using V-Q (voltage relative to reactive power) and P-V (real power relative to voltage) analysis. V-Q analysis evaluates the reactive power required at a bus to maintain stable voltage at that bus. A simulated reactive power source is added to the bus, the voltage schedule at the bus is adjusted in small steps from an initial operating point, and power flows are solved to determine the change in reactive power demand resulting from the change in voltage. Under stable operating conditions, when voltage increases the reactive power requirement also increases, and when voltage

falls the reactive requirement also falls. But when voltage is lowered at the bus and the reactive requirement at that bus begins to increase (rather than continuing to decrease), the system becomes unstable. The voltage point corresponding to the transition from stable to unstable conditions is known as the “critical voltage,” and the reactive power level at that point is the “reactive margin.” The desired operating voltage level should be well above the critical voltage with a large buffer for changes in prevailing system conditions and contingencies. Similarly, reactive margins should be large to assure robust voltage levels and secure, stable system performance.

The illustration below shows a series of V-Q curves. The lowest curve, A, reflects baseline conditions for the grid with all facilities available. Each higher curve represents the same loads and transfers for the region modeled, but with another contingency event (a circuit loss) occurring to make the system less stable. With each additional contingency, the critical voltage rises (the point on the horizontal axis corresponding to the lowest point on the curve) and the reactive margin decreases (the difference between the reactive power at the critical voltage and the zero point on the vertical axis). This means the system is closer to instability.

V-Q (Voltage-Reactive Power) Curves

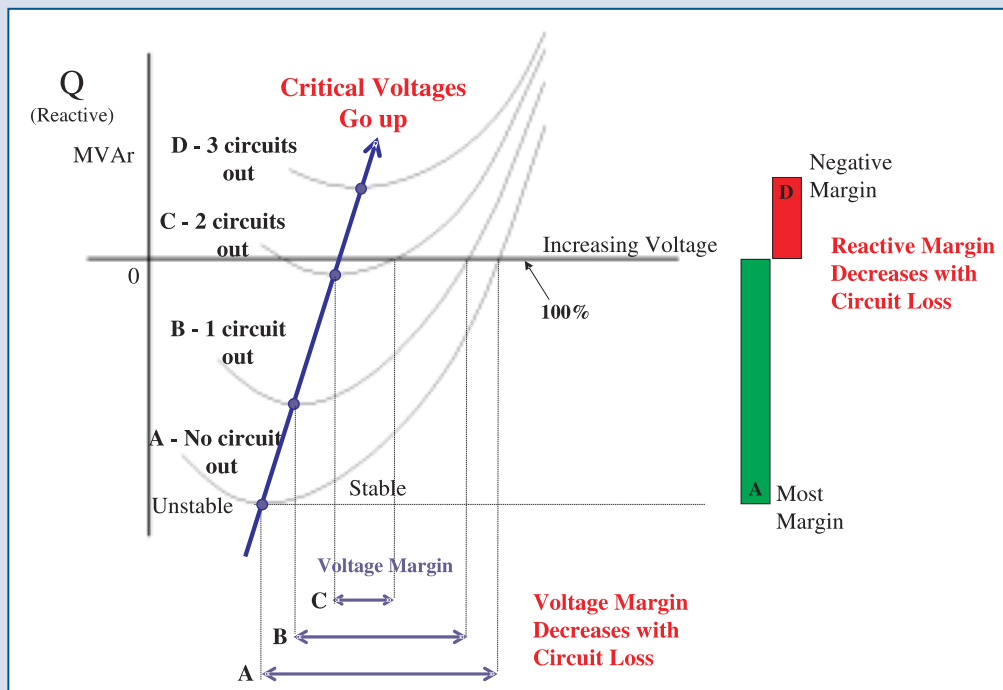

Voltage Stability Analysis (Continued)

V-Q analyses and experience with heavily loaded power systems confirm that critical voltage levels can rise above the 95% level traditionally considered as normal. Thus voltage magnitude alone is a poor indicator of voltage stability and V-Q analysis must be carried out for several critical buses in a local area, covering a range of load and generation conditions and known contingencies that affect voltages at these buses.

P-V analysis (real power relative to voltage) is a companion tool which determines the real power transfer capability across a transmission interface for load supply or a power transfer. Starting from a base case system state, a series of load flows with increasing power transfers are solved while monitoring voltages at critical buses. When power transfers reach a high enough level a stable voltage cannot be sustained and the power flow model fails to solve. The point where the power flow last solved corresponds to the critical voltage level found in the V-Q curve for those conditions. On a P-V curve (see below), this point is called the “nose” of the curve.

This set of P-V curves illustrates that for baseline conditions shown in curve A, voltage remains relatively steady (change along the vertical axis) as load increases within the region (moving out along the horizontal axis). System conditions are secure and stable in the area above the “nose” of

the curve. After a contingency occurs, such as a transmission circuit or generator trip, the new condition set is represented by curve B, with lower voltages (relative to curve A) for any load on curve B. As the operator’s charge is to keep the system stable against the next worst contingency, the system must be operated to stay well inside the load level for the nose of curve B. If the B contingency occurs, there is a next worst contingency curve inside curve B, and the operator must adjust the system to pull back operations to within the safe, buffered space represented by curve C.

The investigation team conducted extensive V-Q and P-V analyses for the area around Cleveland-Akron for the conditions in effect on August 14, 2003. Team members examined over fifty 345-kV and 138-kV buses across the systems of FirstEnergy, AEP, International Transmission Company, Duquesne Light Company, Alleghany Power Systems and Dayton Power & Light. The V-Q analysis alone involved over 10,000 power flow simulations using a system model with more than 43,000 buses and 57,000 lines and transformers. The P-V analyses used the same model and data sets. Both examined conditions and combinations of contingencies for critical times before and after key events on the FirstEnergy system on the day of the blackout.

P-V (Power-Voltage) Curves

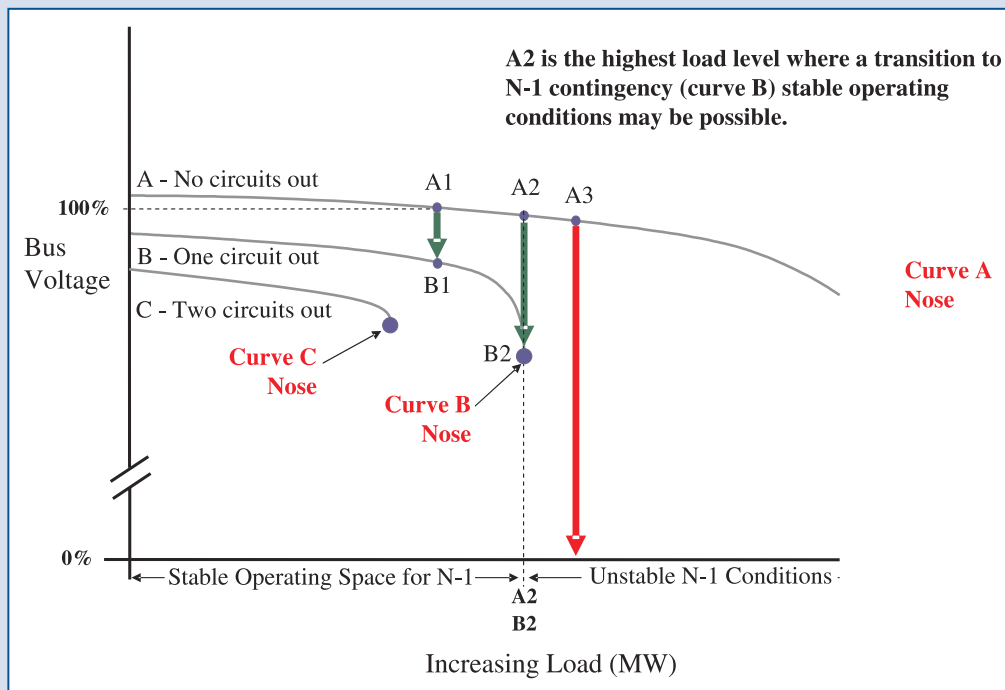

local sources, these healthy reserves nearby could not support the Cleveland-Akron area's reactive power deficiency and growing voltage problems. Even FE's own generation in the Ohio Valley had reactive reserves that could not support the sagging voltages inside the Cleveland-Akron area.

Cause 1
Inadequate System Understanding

An important consideration in reactive power planning is to ensure an appropriate balance between static and dynamic reactive power resources across the interconnected system (as specified in NERC Planning Standard 1D.S1). With so little generation left in the Cleveland-Akron area on August 14, the area's dynamic reactive reserves were depleted and the area relied heavily on static compensation to respond to changing system conditions and support voltages. But a system relying on static compensation can experience a gradual voltage degradation followed by a sudden drop in voltage stability—the P-V curve for such a system has a very steep slope close to the nose, where voltage collapses. On August 14, the lack of adequate dynamic reactive reserves, coupled with not knowing the critical voltages and maximum import capability to serve native load, left the Cleveland-Akron area in a very vulnerable state.

Recommendation
23, page 160

Past System Events and Adequacy of System Studies

Cause 1
Inadequate System Understanding

In June 1994, with three generators in the Cleveland area out on maintenance, inadequate reactive reserves and falling voltages in the Cleveland area forced Cleveland Electric Illuminating (CEI, a predecessor company to FirstEnergy) to shed load within Cleveland (a municipal utility and wholesale transmission and purchase customers within CEI's control area) to avoid voltage collapse.⁷ The Cleveland-Akron area's voltage problems were well-known and reflected in the stringent voltage criteria used by control area operators until 1998.⁸

Cause 1
Inadequate System Understanding

In the summer of 2002, AEP's South Canton 765 kV to 345 kV transformer (which connects to FirstEnergy's Star 345-kV line) experienced eleven days of severe overloading when actual loadings exceeded normal rating and contingency loadings were at or above summer emergency ratings. In each instance, AEP took all available actions short of load shedding to return the system to a secure state, including TLRs, switching, and dispatch adjustments. These excessive loadings were

Figure 4.8. Reactive Reserves Around Ohio on August 14, 2003, for Representative Generators in the Area

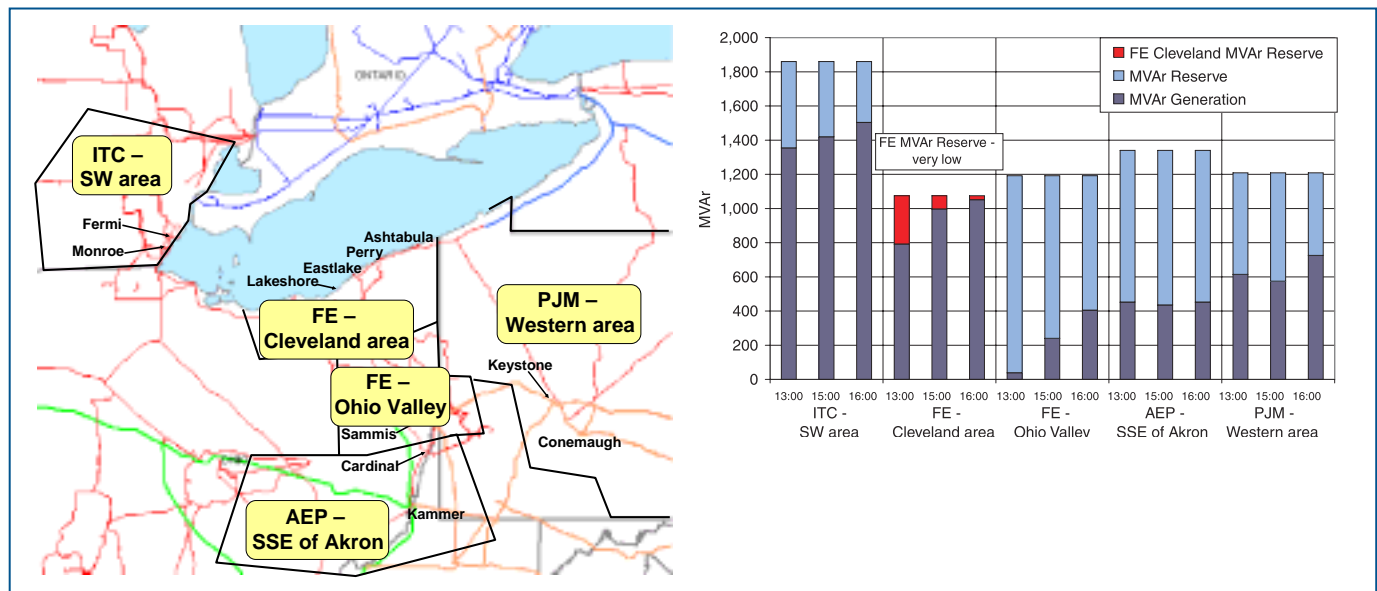

Note: These reactive reserve MVar margins were calculated for the five regions for the following plants: (1) Cleveland area of FirstEnergy—Ashtabula 5, Perry 1, Eastlake 1, Eastlake 3, Lakeshore 18; (2) Northern central portion of AEP near FirstEnergy (South-Southeast of Akron)—Cardinal 1, Cardinal 2, Cardinal 3, Kammer 2, Kammer 3; (3) Southwest area of MECS (ITC)—Fermi 1, Monroe 2, Monroe 3, Monroe 4; (4) Ohio Valley portion of FirstEnergy—Sammis 4, Sammis 5, Sammis 6, Sammis 7; (5) Western portion of PJM—Keystone 1, Conemaugh 1, Conemaugh 2.

calculated to have diminished the remaining life of the transformer by 30%. AEP replaced this single phase transformer in the winter of 2002-03, marginally increasing the capacity of the South Canton transformer bank.

Following these events, AEP conducted extensive modeling to understand the impact of a potential outage of this transformer. That modeling revealed that loss of the South Canton transformer,

especially if it occurred in combination with outages of other critical facilities, would cause significant low voltages and overloads on both the AEP and FirstEnergy systems. AEP shared these findings with FirstEnergy in a meeting on January 10, 2003.⁹

AEP subsequently completed a set of system studies, including long range studies for 2007, which included both single contingency and extreme

Independent Power Producers and Reactive Power

Independent power producers (IPPs) are power plants that are not owned by utilities. They operate according to market opportunities and their contractual agreements with utilities, and may or may not be under the direct control of grid operators. An IPP's reactive power obligations are determined by the terms of its contractual interconnection agreement with the local transmission owner. Under routine conditions, some IPPs provide limited reactive power because they are not required or paid to produce it; they are only paid to produce active power. (Generation of reactive power by a generator can require scaling back generation of active power.) Some contracts, however, compensate IPPs for following a voltage schedule set by the system operator, which requires the IPP to vary its output of reactive power as system conditions change. Further, contracts typically require increased reactive power production from IPPs when it is requested

by the control area operator during times of a system emergency. In some contracts, provisions call for the payment of opportunity costs to IPPs when they are called on for reactive power (i.e., they are paid the value of foregone active power production).

Thus, the suggestion that IPPs may have contributed to the difficulties of reliability management on August 14 because they don't provide reactive power is misplaced. What the IPP is required to produce is governed by contractual arrangements, which usually include provisions for contributions to reliability, particularly during system emergencies. More importantly, it is the responsibility of system planners and operators, not IPPs, to plan for reactive power requirements and make any short-term arrangements needed to ensure that adequate reactive power resources will be available.

Power Flow Simulation of Pre-Cascade Conditions

The bulk power system has no memory. It does not matter if frequencies or voltage were unusual an hour, a day, or a month earlier. What matters for reliability are loadings on facilities, voltages, and system frequency at a given moment and the collective capability of these system components at that same moment to withstand a contingency without exceeding thermal, voltage, or stability limits.

Power system engineers use a technique called power flow simulation to reproduce known operating conditions at a specific time by calibrating an initial simulation to observed voltages and line flows. The calibrated simulation can then be used to answer a series of "what if" questions to determine whether the system was in a safe operating state at that time. The "what if" questions consist of systematically simulating outages by removing key elements (e.g., generators or trans-

mission lines) one by one and reassessing the system each time to determine whether line or voltage limits would be exceeded. If a limit is exceeded, the system is not in a secure state. As described in Chapter 2, NERC operating policies require operators, upon finding that their system is not in a reliable state, to take immediate actions to restore the system to a reliable state as soon as possible and within a maximum of 30 minutes.

To analyze the evolution of the system on the afternoon of August 14, this process was followed to model several points in time, corresponding to key transmission line trips. For each point, three solutions were obtained: (1) conditions immediately before a facility tripped off; (2) conditions immediately after the trip; and (3) conditions created by any automatic actions taken following the trip.

disturbance possibilities. These studies showed that with heavy transfers to the north, expected overloading of the South Canton transformer and depressed voltages would occur following the loss of the Perry unit and the loss of the Tidd-Canton Central 345-kV line, and probable cascading into voltage collapse across northeast Ohio would occur for nine different double contingency combinations of generation and transmission or transmission and transmission outages.¹⁰ AEP shared these findings with FirstEnergy in a meeting on May 21, 2003. Meeting notes indicate that “neither AEP or FE were able to identify any changes in transmission configuration or operating procedures which could be used during 2003 summer to be able to control power flows through the S. Canton bank.”¹¹ Meeting notes include an action item that both “AEP and FE would share the results of these studies and expected performance for 2003 summer with their Management and Operations personnel.”¹²

Reliability coordinators and control areas prepare regional and seasonal studies for a variety of system-stressing scenarios, to better understand potential operational situations, vulnerabilities, risks, and solutions. However, the studies FirstEnergy relied on—both by FirstEnergy and ECAR—were not robust, thorough, or up-to-date. This left FE’s planners and operators with a deficient understanding of their system’s capabilities and risks under a range of system conditions. None of the past voltage events noted above or the significant risks identified in AEP’s 2002-2003 studies are reflected in any FirstEnergy or ECAR seasonal or longer-term planning studies or operating protocols available to the investigation team.

Cause 1
Inadequate System Understanding

FE’s 2003 Summer Study focused primarily on single-contingency (N-1) events, and did not consider significant multiple contingency losses and security. FirstEnergy examined only thermal limits and looked at voltage only to assure that voltage levels remained within range of 90 to 105% of nominal voltage on the 345 kV and 138 kV network. The study assumed that only the Davis-Besse power plant (883 MW) would be out of service at peak load of 13,206 MW; on August 14, peak load reached 12,166 MW and scheduled generation outages included Davis-Besse, Sammis 3 (180 MW) and Eastlake 4 (240 MW), with Eastlake 5 (597 MW) lost in real time. The study assumed that all transmission facilities would be in service; on August 14, scheduled transmission outages included the

Eastlake #62 345/138 kV transformer and the Fox #1 138-kV capacitor, with other capacitors down in real time. Last, the study assumed a single set of import and export conditions, rather than testing a wider range of generation dispatch, import-export, and inter-regional transfer conditions. Overall, the summer study posited less stressful system conditions than actually occurred August 14, 2003 (when load was well below historic peak demand). It did not examine system sensitivity to key parameters to determine system operating limits within the constraints of transient stability, voltage stability, and thermal capability.

Recommendation
23, page 160

Cause 1
Inadequate System Understanding

FirstEnergy has historically relied upon the ECAR regional assessments to identify anticipated reactive power requirements and recommended corrective actions. But ECAR over the past five years has not conducted any detailed analysis of the Cleveland-Akron area and its voltage-constrained import capability—although that constraint had been an operational consideration in the 1990s and was documented in testimony filed in 1996 with the Federal Energy Regulatory Commission.¹³ The voltage-constrained import capability was not studied; FirstEnergy had modified the criteria around 1998 and no longer followed the tighter voltage limits used earlier. In the ECAR “2003 Summer Assessment of Transmission System Performance,” dated May 2003, First Energy’s Individual Company Assessment identified potential overloads for the loss of both Star 345/138 transformers, but did not mention any expected voltage limitation.

Recommendation
3, page 143

FE participates in ECAR studies that evaluate extreme contingencies and combinations of events. ECAR does not conduct exacting region-wide analyses, but compiles individual members’ internal studies of N-2 and multiple contingencies (which may include loss of more than one circuit, loss of a transmission corridor with several transmission lines, loss of a major substation or generator, or loss of a major load pocket). The last such study conducted was published in 2000, projecting system conditions for 2003. That study did not include any contingency cases that resulted in 345-kV line overloading or voltage violations on 345-kV buses. FE reported no evidence of a risk of cascading, but reported that some local load would be lost and generation redispatch would be needed to alleviate some thermal overloads.

ECAR and Organizational Independence

ECAR was established in 1967 as a regional reliability council, to “augment the reliability of the members’ electricity supply systems through coordination of the planning and operation of the members’ generation and transmission facilities.”^a ECAR’s membership includes 29 major electricity suppliers serving more than 36 million people.

ECAR’s annual budget for 2003 was \$5.15 million (U.S.), including \$1.775 million (U.S.) paid to fund NERC.^b These costs are funded by its members in a formula that reflects megawatts generated, megawatt load served, and miles of high voltage lines. AEP, ECAR’s largest member, pays about 15% of total ECAR expenses; FirstEnergy pays approximately 8 to 10%.^c

Utilities “whose generation and transmission have an impact on the reliability of the interconnected electric systems” of the region are full ECAR members, while small utilities, independent power producers, and marketers can be associate members.^d Its Executive Board has 22 seats, one for each full member utility or major supplier (including every control area operator in ECAR). Associate members do not have voting rights, either on the Board or on the technical committees which do all the work and policy-setting for the ECAR region.

All of the policy and technical decisions for ECAR, including all interpretations of NERC guidelines, policies, and standards within ECAR, are developed by committees (called “panels”), staffed by representatives from the ECAR member companies. Work allocation and leadership within ECAR are provided by the Board, the Coordination Review Committee, and the Market Interface Committee.

ECAR has a staff of 18 full-time employees, headquartered in Akron, Ohio. The staff provides engineering analysis and support to the various committees and working groups. Ohio Edison, a FirstEnergy subsidiary, administers salary, benefits, and accounting services for ECAR. ECAR employees automatically become part of Ohio Edison’s (FirstEnergy’s) 401(k) retirement plan; they receive FE stock as a matching share to employee 401(k) investments and can purchase FE stock as well. Neither ECAR staff nor board members are required to divest stock holdings in ECAR member companies.^e Despite the close link between FirstEnergy’s financial health and the interest of ECAR’s staff and management, the investigation team has found no evidence to suggest that ECAR staff favor FirstEnergy’s interests relative to other members.

ECAR decisions appear to be dominated by the member control areas, which have consistently allowed the continuation of past practices within each control area to meet NERC requirements, rather than insisting on more stringent, consistent requirements for such matters as operating voltage criteria or planning studies. ECAR member representatives also staff the reliability council’s audit program, measuring individual control area compliance against local standards and interpretations. It is difficult for an entity dominated by its members to find that the members’ standards and practices are inadequate. But it should also be recognized that NERC’s broadly worded and ambiguous standards have enabled and facilitated the lax interpretation of reliability requirements within ECAR over the years.

Recommendations
2, page 143; 3, page 143

^aECAR “Executive Manager’s Remarks,” <http://www.ecar.org>.

^bInterview with Brantley Eldridge, ECAR Executive Manager, March 10, 2004.

^cInterview with Brantley Eldridge, ECAR Executive Manager, March 3, 2004.

^dECAR “executive Manager’s Remarks,” <http://www.ecar.org>.

^eInterview with Brantley Eldridge, ECAR Executive Manager, March 3, 2004.

Model-Based Analysis of the State of the Regional Power System at 15:05 EDT, Before the Loss of FE’s Harding-Chamberlin 345-kV Line

As the first step in modeling the August 14 blackout, the investigation team established a base case by creating a power flow simulation for the entire Eastern Interconnection and benchmarking it to recorded system conditions at 15:05 EDT on August 14. The team started with a projected summer 2003 power flow case for the Eastern Interconnection developed in the spring of 2003 by the Regional Reliability Councils to establish guidelines for safe operations for the coming summer. The level of detail involved in this region-wide power flow case far exceeds that normally considered by individual control areas and reliability coordinators. It consists of a detailed representation of more than 43,000 buses, 57,600 transmission lines, and all major generating stations across the northern U.S. and eastern Canada. The team revised the summer power flow case to match recorded generation, demand, and power interchange levels among control areas at 15:05 EDT on August 14. The benchmarking consisted of matching the calculated voltages and line flows to recorded observations at more than 1,500 locations within the grid. Thousands of hours of effort were required to benchmark the model satisfactorily to observed conditions at 15:05 EDT.

Once the base case was benchmarked, the team ran a contingency analysis that considered more than 800 possible events—including the loss of the Harding-Chamberlin 345-kV line—as points of departure from the 15:05 EDT case. None of these contingencies resulted in a violation of a transmission line loading or bus voltage limit prior to the trip of FE’s Harding-Chamberlin 345-kV line. That is, according to these simulations, the system at 15:05 EDT was capable of safe operation following the occurrence of any of the tested contingencies. From an electrical standpoint, therefore, *before* 15:05 EDT the Eastern Interconnection was being operated within all established limits and in full compliance with NERC’s operating policies. However, *after* loss of the Harding-Chamberlin 345-kV line, the system would have exceeded emergency ratings immediately on several lines for two of the contingencies studied—in other words, it would no longer be operating in compliance with NERC Operating Policy A.2 because it could not be

brought back into a secure operating condition within 30 minutes.

Perry Nuclear Plant as a First Contingency

Investigation team modeling demonstrates that the Perry nuclear unit (1,255 MW near Lake Erie) is critical to the voltage stability of the Cleveland-Akron area in general and particularly on August 14. The modeling reveals that had Perry tripped before 15:05 EDT, voltage levels at key FirstEnergy buses would have fallen close to 93% with only a 150 MW of area load margin (2% of the Cleveland-Akron area load); but had Perry been lost after the Harding-Chamberlin line went down at 15:05 EDT, the Cleveland-Akron area would have been close to voltage collapse.

Cause 1
Inadequate System Understanding

Perry and Eastlake 5 together have a combined real power capability of 1,852 MW and reactive capability of 930 MVar. If one of these units is lost, it is necessary to

immediately replace the lost generation with MW and MVar imports (although reactive power does not travel far under heavy loading); without quick-start generation or spinning reserves or dynamic reactive reserves inside the Cleveland-Akron area, system security may be jeopardized. On August 14, as noted previously, there were no significant spinning reserves remaining within the Cleveland-Akron area following the loss of Eastlake 5 at 13:31 EDT. If Perry had been lost FE would have been unable to meet the 30-minute security adjustment requirement of NERC’s Operating Policy 2, without the ability to shed load quickly. The loss of Eastlake 5 followed by the loss of Perry are contingencies that should be assessed in the operations planning timeframe, to develop measures to readjust the system between contingencies. Since FirstEnergy did not conduct such contingency analysis planning and develop these advance measures, it was in violation of NERC Planning Standard 1A, Category C3.

Recommendation
23, page 160

This operating condition is not news. Historically, the loss of Perry at full output has been recognized as FE’s most critical single contingency for the Cleveland Electric Illuminating area, as documented by FE’s 1998 Summer Import Capability study. Perry’s MW and MVar total output capability exceeded the import capability of any of the critical 345-kV circuits into the Cleveland-Akron area after the loss of Eastlake 5 at 13:31 EDT. This

means that if the Perry plant had been lost on August 14 after Eastlake 5 went down—or on many other days with similar loads and outages—it would have been difficult or impossible for FE operators to adjust the system within 30 minutes to prepare for the next critical contingency, as required by NERC Operating Policy A.2. In real-time operations, operators would have to calculate operating limits and prepare to use the last resort of manually shedding large blocks of load before the second contingency, or immediately after it if automatic load-shedding is available.

Cause 1
Inadequate System Understanding

The investigation team could not find FirstEnergy contingency plans or operational procedures for operators to manage the FirstEnergy control area and protect the Cleveland-Akron area from the unexpected loss of the Perry plant.

protect the Cleveland-Akron area from the unexpected loss of the Perry plant.

To examine the impact of this worst contingency on the Cleveland-Akron area on August 14, Figure 4.9 shows the V-Q curves for key buses in the Cleveland-Akron area at 15:05 EDT, before and after the loss of the Harding-Chamberlin line. The curves on the left look at the impact of the loss of Perry before the Harding-Chamberlin trip, while the curves on the right show the impact had the nuclear plant been lost after Harding-Chamberlin went out of service. Had Perry gone down *before* the Harding-Chamberlin outage, reactive margins at key FE buses would have been minimal (with the tightest margin at the Harding bus, read along the Y-axis) and the critical voltage (the point before voltage collapse, read along the X-axis) at

Recommendation
23, page 160

Figure 4.9. Loss of the Perry Unit Hurts Critical Voltages and Reactive Reserves: V-Q Analyses

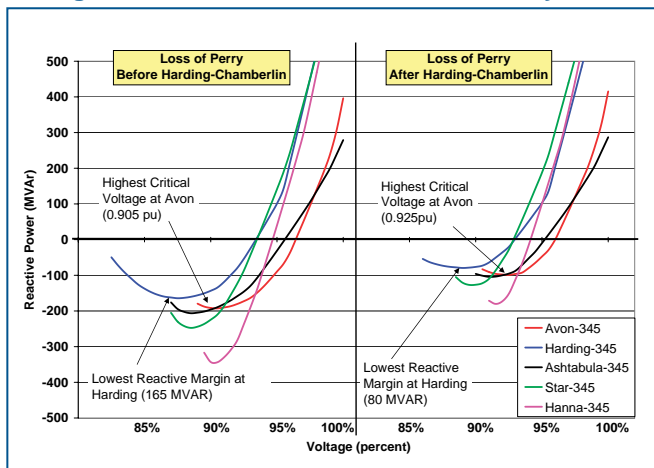

the Avon bus would have risen to 90.5%—uncomfortably close to the limits which FE considered as an acceptable operating range. But had the Perry unit gone off-line *after* Harding-Chamberlin, reactive margins at all these buses would have been even tighter (with only 60 MVAR at the Harding bus), and critical voltage at Avon would have risen to 92.5%, worse than FE’s 90% minimum acceptable voltage. The system at this point would be very close to voltage instability. If the first line outage on August 14, 2003, had been at Hanna-Juniper rather than at Harding-Chamberlin, the FirstEnergy system could not have withstood the loss of the Perry plant.

Cause 1
Inadequate System Understanding

The above analysis assumed load levels consistent with August 14. But temperatures were not particularly high that day and loads were nowhere near FE’s historic

load level of 13,229 MW for the control area (in August 2002). Therefore the investigation team looked at what might have happened in the Cleveland-Akron area had loads neared the historic peak—approximately 625 MW higher than the 6,715 MW peak load in the Cleveland-Akron area in 2003. Figure 4.10 uses P-V analysis to show the impact of increased load levels on voltages at the Star bus with and without the Perry unit before the loss of the Harding-Chamberlin line at 15:05 EDT. The top line shows that with the Perry plant available, local load could have increased by 625 MW and voltage at Star would have remained above 95%. But the bottom line, simulating the loss of Perry, indicates that load could only have increased by about 150 MW before voltage at Star would have become unsolvable, indicating no voltage stability margin and depending on load dynamics, possible voltage collapse.

The above analyses indicate that the Cleveland-Akron area was highly vulnerable on the afternoon of August 14. Although the system was compliant with NERC Operating Policy 2A.1 for single contingency reliability before the loss of the Harding-Chamberlin line at 15:05 EDT, had FE lost the Perry plant its system would have neared voltage instability or could have gone into a full voltage collapse immediately if the Cleveland-Akron area load were 150 MW higher. It is worth noting that this could have happened on August 14—at 13:43 EDT that afternoon, the Perry plant operator called the control area operator to warn about low voltages. At 15:36:51 EDT the Perry plant operator called FirstEnergy’s system control center to ask about voltage spikes at the plant’s main

transformer.¹⁴ At 15:42:49 EDT the Perry operator called the FirstEnergy operator to say, “I’m still getting a lot of voltage spikes and swings on the generator . . . I’m taking field volts pretty close to where I’ll trip the turbine off.”¹⁵

System Frequency

Assuming stable conditions, the system frequency is the same across an interconnected grid at any particular moment. System frequency will vary from moment to moment, however, depending on the second-to-second balance between aggregate generation and aggregate demand across the interconnection. System frequency is monitored on a continuous basis.

There were no significant or unusual frequency oscillations in the Eastern Interconnection on August 14 prior to 16:09 EDT compared to prior days, and frequency was well within the bounds of safe operating practices. System frequency variation was not a cause or precursor of the initiation of the blackout. But once the cascade began, the large frequency swings that occurred early on became a principal means by which the blackout spread across a wide area.

Figure 4.11 shows Eastern Interconnection frequency on August 14, 2003. Frequency declines or increases from a mismatch between generation and load on the order of about 3,200 MW per 0.1 Hertz (alternatively, a change in load or generation of 1,000 MW would cause a frequency

change of about ± 0.031 Hz). Significant frequency excursions reflect large changes in load relative to generation and could cause unscheduled flows between control areas and even, in the extreme, cause automatic under-frequency load-shedding or automatic generator trips.

The investigation team examined Eastern Interconnection frequency and Area Control Error (ACE) for August 14, 2003 and the entire month of August, looking for patterns and anomalies. Extensive analysis using Fast Fourier Transforms (described in the NERC Technical Report) revealed no unusual variations. Rather, transforms using various time samples of average frequency (from 1 hour to 6 seconds in length) indicate instead that the Eastern Interconnection exhibits regular deviations.¹⁶

The largest deviations in frequency occur at regular intervals. These intervals reflect interchange

Figure 4.10. Impact of Perry Unit Outage on Cleveland-Akron Area Voltage Stability

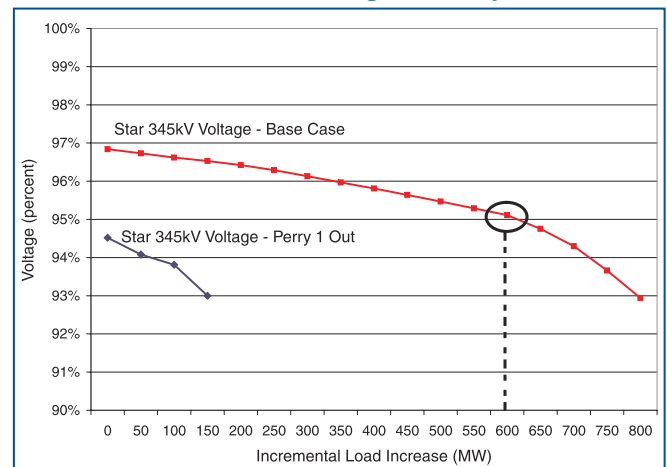
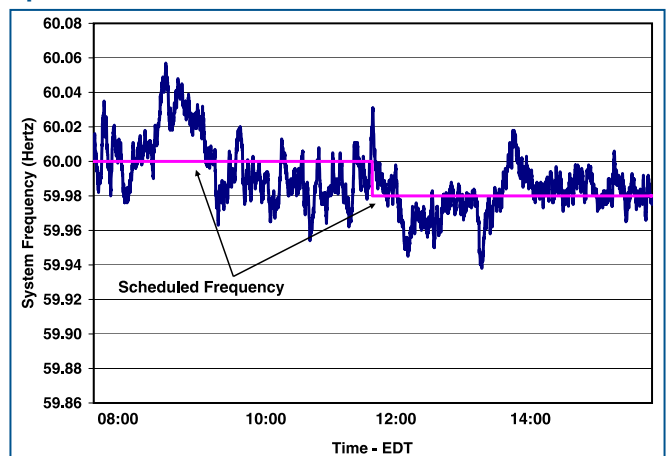

Figure 4.11. Frequency on August 14, 2003, up to 16:09 EDT



Frequency Management

Each control area is responsible for maintaining a balance between its generation and demand. If persistent under-frequency occurs, at least one control area somewhere is “leaning on the grid,” meaning that it is taking unscheduled electricity from the grid, which both depresses system frequency and creates unscheduled power flows. In practice, minor deviations at the control area level are routine; it is very difficult to maintain an exact balance between generation and demand. Accordingly, NERC has established operating rules that specify maximum permissible deviations, and focus on prohibiting persistent deviations, but not instantaneous ones. NERC monitors the performance of control areas through specific measures of control performance that gauge how accurately each control area matches its load and generation.

schedule changes at the peak to off-peak schedule changes (06:00 to 07:00 and 21:00 to 22:00, as shown in Figure 4.12) and on regular hourly and half-hour schedule changes as power plants ramp up and down to serve scheduled purchases and interchanges. Frequency tends to run high in the early part of the day because extra generation capacity is committed and waiting to be dispatched for the afternoon peak, and then runs lower in the afternoon as load rises relative to available generation and spinning reserve. The investigation team concluded that frequency data collection and frequency management in the Eastern Interconnection should be improved, but that frequency oscillations before 16:09 EDT on August 14 had no effect on the blackout.

Conclusion

Determining that the system was in a reliable operational state at 15:05 EDT is extremely significant for understanding the causes of the blackout. It means that none of the electrical conditions on the system before 15:05 EDT was a cause of the blackout. This eliminates low voltages earlier in the day or on prior days, the unavailability of individual generators or transmission lines (either individually or in combination with one another), high power flows to Canada, unusual system frequencies, and many other issues as direct, principal or sole causes of the blackout.

Although FirstEnergy's system was technically in secure electrical condition before 15:05 EDT, it was still highly vulnerable, because some of its assumptions and limits were not accurate for safe operating criteria. Analysis of Cleveland-Akron area voltages and reactive margins shows that FirstEnergy was operating that system on the very edge of NERC operational reliability standards, and that it could have been compromised by a number of potentially disruptive scenarios that were foreseeable by thorough planning and operations studies. A system with this little reactive margin would leave little room for adjustment, with few relief actions available to operators in the face of single or multiple contingencies. As the next chapter will show, the vulnerability created by inadequate system planning and understanding was exacerbated because the FirstEnergy operators were not adequately trained or prepared to recognize and deal with emergency situations.

Figure 4.12. Hourly Deviations in Eastern Interconnection Frequency for the Month of August 2003

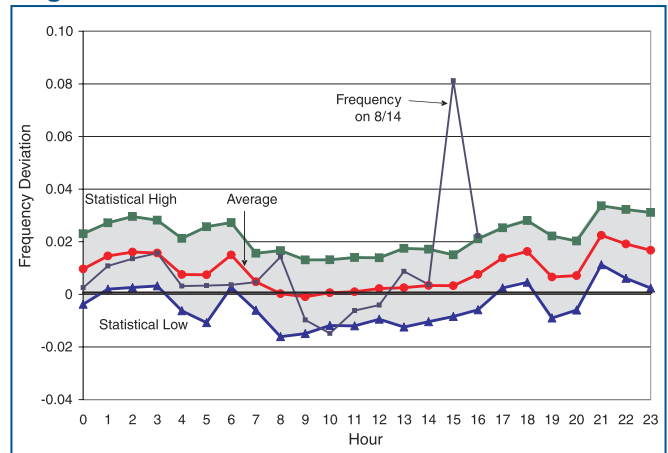

Endnotes

- 1 FE transcripts, Channel 14, 13:33:44.
- 2 FE transcripts, Channel 14 at 13:21:05; channel 3 at 13:41:54; 15:30:36.
- 3 “ECAR Investigation of August 14, 2003 Blackout by Major System Disturbance Analysis Task Force, Recommendations Report,” page 6.
- 4 Transmission operator at FE requested the restoration of the Avon Substation capacitor bank #2. Example at Channel 3, 13:33:40. However, no additional capacitors were available.
- 5 From 13:13 through 13:28, reliability operator at FE called nine plant operators to request additional voltage support. Examples at Channel 16, 13:13:18, 13:15:49, 13:16:44, 13:20:44, 13:22:07, 13:23:24, 13:24:38, 13:26:04, 13:28:40.
- 6 DOE/NERC fact-finding meeting, September 2003, statement by Mr. Steve Morgan (FE), PR0890803, lines 5-23.
- 7 See 72 FERC 61,040, the order issued for FERC dockets EL 94-75-000 and EL 94-80-000, for details of this incident.
- 8 Testimony by Stanley Szwed, Vice President of Engineering and Planning, Centerior Service Company (Cleveland Electric Illuminating Company and Toledo Edison), FERC docket EL 94-75-000, February 22, 1996.
- 9 Presentation notes for January 10, 2003 meeting between AEP and FirstEnergy, and meeting summary notes by Paul Johnson, AEP Manager, East Bulk Transmission Planning, January 10, 2003.
- 10 “Talking Points” for May 21, 2003 meeting between AEP and FirstEnergy, prepared by AEP.
- 11 Memo, “Summary of AEP/FE Meeting on 5/21/03,” by Scott P. Lockwood, AEP, May 29, 2003.
- 12 *Ibid.*
- 13 Testimony by Stanley Szwed, Vice President of Engineering and Planning, Centerior Service Company (Cleveland Electric Illuminating Company and Toledo Edison), FERC docket EL 94-75-000, February 22, 1996.
- 14 FE transcript, Channel 8.
- 15 FE transcript, Channel 8.
- 16 See NERC Blackout Investigation Technical Reports, to be released in 2004.

5. How and Why the Blackout Began in Ohio

Summary

This chapter explains the major events—electrical, computer, and human—that occurred as the blackout evolved on August 14, 2003, and identifies the causes of the initiation of the blackout. The period covered in this chapter begins at 12:15 Eastern Daylight Time (EDT) on August 14, 2003 when inaccurate input data rendered MISO’s state estimator (a system monitoring tool) ineffective. At 13:31 EDT, FE’s Eastlake 5 generation unit tripped and shut down automatically. Shortly after 14:14 EDT, the alarm and logging system in FE’s control room failed and was not restored until after the blackout. After 15:05 EDT, some of FE’s 345-kV transmission lines began tripping out because the lines were contacting overgrown trees within the lines’ right-of-way areas.

By around 15:46 EDT when FE, MISO and neighboring utilities had begun to realize that the FE system was in jeopardy, the only way that the blackout might have been averted would have been to drop at least 1,500 MW of load around Cleveland and Akron. No such effort was made, however, and by 15:46 EDT it may already have been too late for a large load-shed to make any difference. After 15:46 EDT, the loss of some of FE’s key 345-kV lines in northern Ohio caused its underlying network of 138-kV lines to begin to fail, leading in turn to the loss of FE’s Sammis-Star 345-kV line at 16:06 EDT. The chapter concludes with the loss of FE’s Sammis-Star line, the event that triggered the uncontrollable 345 kV cascade portion of the blackout sequence.

The loss of the Sammis-Star line triggered the cascade because it shut down the 345-kV path into northern Ohio from eastern Ohio. Although the area around Akron, Ohio was already blacked out due to earlier events, most of northern Ohio remained interconnected and electricity demand was high. This meant that the loss of the heavily overloaded Sammis-Star line instantly created major and unsustainable burdens on lines in adjacent areas, and the cascade spread rapidly as lines

and generating units automatically tripped by protective relay action to avoid physical damage.

Chapter Organization

This chapter is divided into several phases that correlate to major changes within the FirstEnergy system and the surrounding area in the hours leading up to the cascade:

- ◆ **Phase 1:** A normal afternoon degrades
- ◆ **Phase 2:** FE’s computer failures
- ◆ **Phase 3:** Three FE 345-kV transmission line failures and many phone calls
- ◆ **Phase 4:** The collapse of the FE 138-kV system and the loss of the Sammis-Star line.

Key events within each phase are summarized in Figure 5.1, a timeline of major events in the origin of the blackout in Ohio. The discussion that follows highlights and explains these significant events within each phase and explains how the events were related to one another and to the cascade. Specific causes of the blackout and associated recommendations are identified by icons.

Phase 1: A Normal Afternoon Degrades: 12:15 EDT to 14:14 EDT

Overview of This Phase

Northern Ohio was experiencing an ordinary August afternoon, with loads moderately high to serve air conditioning demand, consuming high levels of reactive power. With two of Cleveland’s active and reactive power production anchors already shut down (Davis-Besse and Eastlake 4), the loss of the Eastlake 5 unit at 13:31 EDT further depleted critical voltage support for the Cleveland-Akron area. Detailed simulation modeling reveals that the loss of Eastlake 5 was a significant factor in the outage later that afternoon—with Eastlake 5 out of service, transmission line

Figure 5.1. Timeline: Start of the Blackout in Ohio

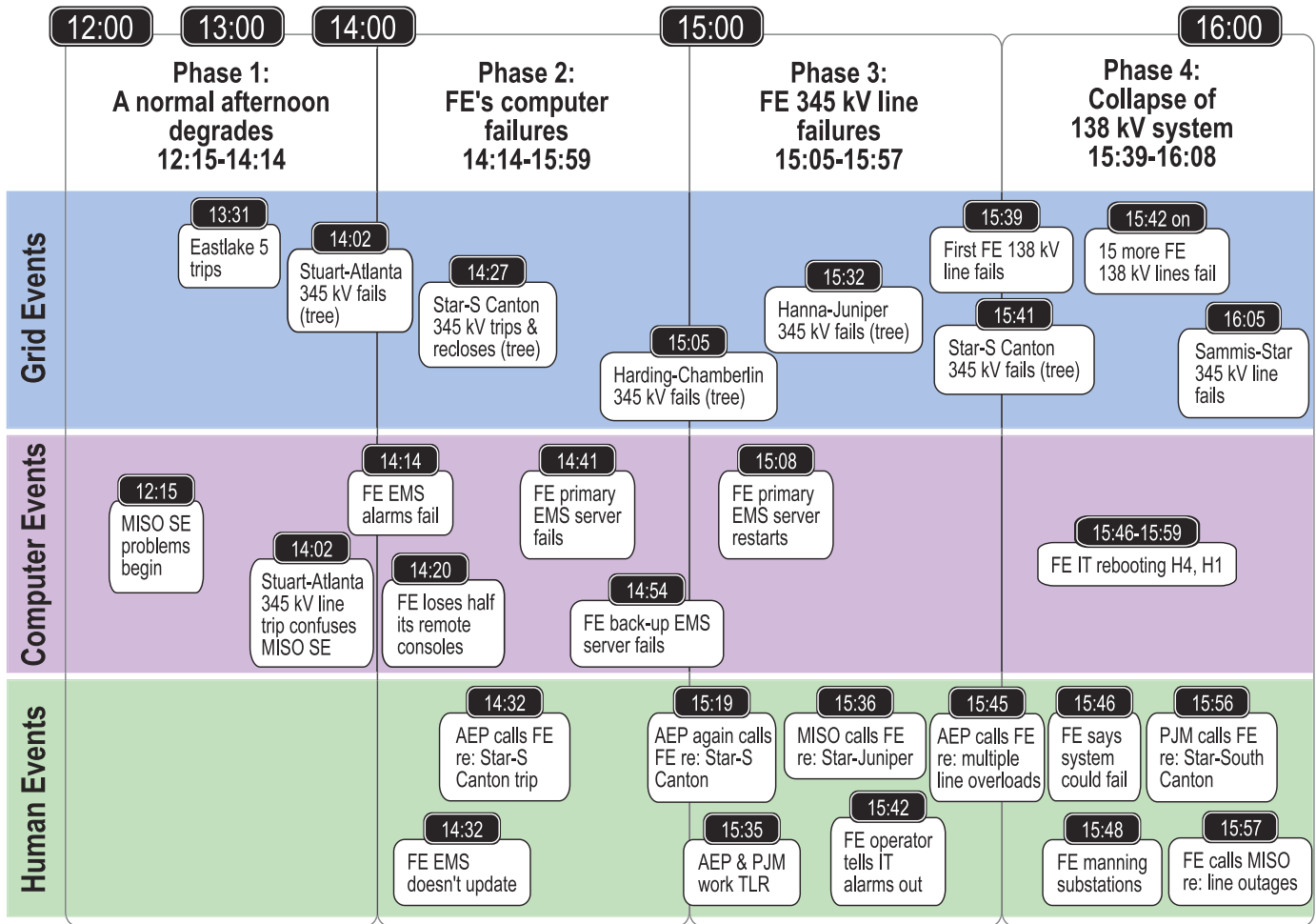

loadings were notably higher but well within normal ratings. After the loss of FE’s Harding-Chamberlin line at 15:05 EDT, the system eventually became unable to sustain additional contingencies, even though key 345 kV line loadings did not exceed their normal ratings. Had Eastlake 5 remained in service, subsequent line loadings would have been lower. Loss of Eastlake 5, however, did not initiate the blackout. Rather, subsequent computer failures leading to the loss of situational awareness in FE’s control room and the loss of key FE transmission lines due to contacts with trees were the most important causes.

At 14:02 EDT, Dayton Power & Light’s (DPL) Stuart-Atlanta 345-kV line tripped off-line due to a tree contact. This line had no direct electrical effect on FE’s system—but it did affect MISO’s performance as reliability coordinator, even though PJM is the reliability coordinator for the DPL line. One of MISO’s primary system condition evaluation tools, its state estimator, was unable to assess system conditions for most of the period between

12:15 and 15:34 EDT, due to a combination of human error and the effect of the loss of DPL’s Stuart-Atlanta line on other MISO lines as reflected in the state estimator’s calculations. Without an effective state estimator, MISO was unable to perform contingency analyses of generation and line losses within its reliability zone. Therefore, through 15:34 EDT MISO could not determine that with Eastlake 5 down, other transmission lines would overload if FE lost a major transmission line, and could not issue appropriate warnings and operational instructions.

In the investigation interviews, all utilities, control area operators, and reliability coordinators indicated that the morning of August 14 was a reasonably typical day.¹ FE managers referred to it as peak load conditions on a less than peak load day. Dispatchers consistently said that while voltages were low, they were consistent with historical voltages.² Throughout the morning and early afternoon of August 14, FE reported a growing need for voltage support in the upper Midwest.

The FE reliability operator was concerned about low voltage conditions on the FE system as early as 13:13 EDT. He asked for voltage support (i.e., increased reactive power output) from FE's interconnected generators. Plants were operating in automatic voltage control mode (reacting to system voltage conditions and needs rather than constant reactive power output). As directed in FE's Manual of Operations,³ the FE reliability operator began to call plant operators to ask for additional voltage support from their units. He noted to most of them that system voltages were sagging "all over." Several mentioned that they were already at or near their reactive output limits. None were

asked to reduce their real power output to be able to produce more reactive output. He called the Sammis plant at 13:13 EDT, West Lorain at 13:15 EDT, Eastlake at 13:16 EDT, made three calls to unidentified plants between 13:20 EDT and 13:23 EDT, a "Unit 9" at 13:24 EDT, and two more at 13:26 EDT and 13:28 EDT.⁴ The operators worked to get shunt capacitors at Avon that were out of service restored to support voltage,⁵ but those capacitors could not be restored to service.

Following the loss of Eastlake 5 at 13:31 EDT, FE's operators' concern about voltage levels increased. They called Bay Shore at 13:41 EDT and Perry at

Energy Management System (EMS) and Decision Support Tools

Operators look at potential problems that could arise on their systems by using contingency analyses, driven from state estimation, that are fed by data collected by the SCADA system.

SCADA: System operators use System Control and Data Acquisition systems to acquire power system data and control power system equipment. SCADA systems have three types of elements: field remote terminal units (RTUs), communication to and between the RTUs, and one or more Master Stations.

Field RTUs, installed at generation plants and substations, are combination data gathering and device control units. They gather and provide information of interest to system operators, such as the status of a breaker (switch), the voltage on a line or the amount of real and reactive power being produced by a generator, and execute control operations such as opening or closing a breaker. Telecommunications facilities, such as telephone lines or microwave radio channels, are provided for the field RTUs so they can communicate with one or more SCADA Master Stations or, less commonly, with each other.

Master stations are the pieces of the SCADA system that initiate a cycle of data gathering from the field RTUs over the communications facilities, with time cycles ranging from every few seconds to as long as several minutes. In many power systems, Master Stations are fully integrated into the control room, serving as the direct interface to the Energy Management System (EMS), receiving incoming data from the field RTUs and relaying control operations commands to the field devices for execution.

State Estimation: Transmission system operators must have visibility (condition information) over

their own transmission facilities, and recognize the impact on their own systems of events and facilities in neighboring systems. To accomplish this, system state estimators use the real-time data measurements available on a subset of those facilities in a complex mathematical model of the power system that reflects the configuration of the network (which facilities are in service and which are not) and real-time system condition data to estimate voltage at each bus, and to estimate real and reactive power flow quantities on each line or through each transformer. Reliability coordinators and control areas that have them commonly run a state estimator on regular intervals or only as the need arises (i.e., upon demand). Not all control areas use state estimators.

Contingency Analysis: Given the state estimator's representation of current system conditions, a system operator or planner uses contingency analysis to analyze the impact of specific outages (lines, generators, or other equipment) or higher load, flow, or generation levels on the security of the system. The contingency analysis should identify problems such as line overloads or voltage violations that will occur if a new event (contingency) happens on the system. Some transmission operators and control areas have and use state estimators to produce base cases from which to analyze next contingencies ("N-1," meaning normal system minus 1 key element) from the current conditions. This tool is typically used to assess the reliability of system operation. Many control areas do not use real time contingency analysis tools, but others run them on demand following potentially significant system events.

Figure 5.2. Timeline Phase 1

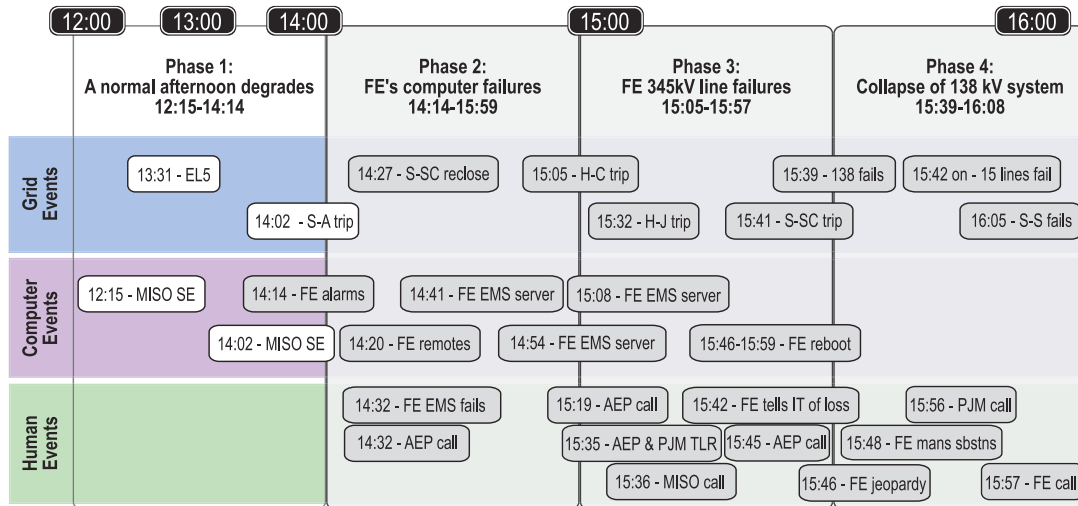

13:43 EDT to ask the plants for more voltage support. Again, while there was substantial effort to support voltages in the Ohio area, FirstEnergy personnel characterized the conditions as not being unusual for a peak load day, although this was not an all-time (or record) peak load day.⁶

Key Phase 1 Events

- 1A) 12:15 EDT to 16:04 EDT: MISO’s state estimator software solution was compromised, and MISO’s single contingency reliability assessment became unavailable.
- 1B) 13:31:34 EDT: Eastlake Unit 5 generation tripped in northern Ohio.
- 1C) 14:02 EDT: Stuart-Atlanta 345-kV transmission line tripped in southern Ohio.

1A) MISO’s State Estimator Was Turned Off: 12:15 EDT to 16:04 EDT

It is common for reliability coordinators and control areas to use a state estimator (SE) to improve the accuracy of the raw sampled data they have for the electric system by mathematically processing raw data to make it consistent with the electrical system model. The resulting information on equipment voltages and loadings is used in software tools such as real time contingency analysis (RTCA) to simulate various conditions and outages to evaluate the reliability of the power system. The RTCA tool is used to alert operators if the system is operating insecurely; it can be run either on a regular schedule (e.g., every 5 minutes), when triggered by some system event (e.g., the loss of a power plant or transmission line), or when initiated by an operator. MISO usually runs the SE

every 5 minutes, and the RTCA less frequently. If the model does not have accurate and timely information about key pieces of system equipment or if key input data are wrong, the state estimator may be unable to reach a solution or it will reach a solution that is labeled as having a high degree of error. In August, MISO considered its SE and RTCA tools to be still under development and not fully mature; those systems have since been completed and placed into full operation.

On August 14 at about 12:15 EDT, MISO’s state estimator produced a solution with a high mismatch (outside the bounds of acceptable error). This was traced to an outage of Cinergy’s Bloomington-Denois Creek 230-kV line—although it was out of service, its status was not updated in MISO’s state estimator. Line status information within MISO’s reliability coordination area is transmitted to MISO by the ECAR data network or direct links and is intended to be automatically linked to the SE. This requires coordinated data naming as well as instructions that link the data to the tools. For this line, the automatic linkage of line status to the state estimator had not yet been established. The line status was corrected and MISO’s analyst obtained a good SE solution at 13:00 EDT and an RTCA solution at 13:07 EDT. However, to troubleshoot this problem the analyst had turned off the automatic trigger that runs the state estimator every five minutes. After fixing the problem he forgot to re-enable it, so although he had successfully run the SE and RTCA manually to reach a set of correct system analyses, the tools were not returned to normal automatic operation. Thinking the system had been successfully restored, the analyst went to lunch.

Cause 4
Inadequate
RC Diagnostic
Support

The fact that the state estimator was not running automatically on its regular 5-minute schedule was discovered about 14:40 EDT. The automatic trigger was re-enabled

but again the state estimator failed to solve successfully. This time investigation identified the Stuart-Atlanta 345-kV line outage (which occurred at 14:02 EDT) to be the likely cause. This line is within the Dayton Power and Light control area in southern Ohio and is under PJM's reliability umbrella rather than MISO's. Even though it affects electrical flows within MISO, its status had not been automatically linked to MISO's state estimator.

The discrepancy between actual measured system flows (with Stuart-Atlanta off-line) and the MISO model (which assumed Stuart-Atlanta on-line) prevented the state estimator from solving correctly. At 15:09 EDT, when informed by the system engineer that the Stuart-Atlanta line appeared to be the problem, the MISO operator said (mistakenly) that this line was in service. The system engineer then tried unsuccessfully to reach a solution with the Stuart-Atlanta line modeled as in service until approximately 15:29 EDT, when the MISO operator called PJM to verify the correct status. After they determined that Stuart-Atlanta had tripped, they updated the state estimator and it solved successfully. The RTCA was then run manually and solved successfully at 15:41 EDT. MISO's state estimator and contingency analysis were back under full automatic operation and solving effectively by 16:04 EDT, about two minutes before the start of the cascade.

In summary, the MISO state estimator and real time contingency analysis tools were effectively out of service between 12:15 EDT and 16:04 EDT. This prevented MISO from promptly performing precontingency "early warning" assessments of power system reliability over the afternoon of August 14.

Recommendations
3, page 143; 6, page 147;
30, page 163

1B) Eastlake Unit 5 Tripped: 13:31 EDT

Eastlake Unit 5 (rated at 597 MW) is in northern Ohio along the southern shore of Lake Erie, connected to FE's 345-kV transmission system (Figure 5.3). The Cleveland and Akron loads are generally supported by generation from a combination of the Eastlake, Perry and Davis-Besse units, along with significant imports, particularly from 9,100 MW of generation located along the Ohio and Pennsylvania border. The unavailability of

Eastlake 4 and Davis-Besse meant that FE had to import more energy into the Cleveland-Akron area to support its load.

When Eastlake 5 dropped off-line, replacement power transfers and the associated reactive power to support the imports to the local area contributed to the additional line loadings in the region. At 15:00 EDT on August 14, FE's load was approximately 12,080 MW, and they were importing about 2,575 MW, 21% of their total. FE's system reactive power needs rose further.

Cause 1
Inadequate
System
Understanding

The investigation team's system simulations indicate that the loss of Eastlake 5 was a critical step in the sequence of events. Contingency analysis simulation of the conditions following the loss of the Harding-Chamberlin 345-kV circuit at 15:05 EDT showed that the system would be unable to sustain some contingencies without line overloads above emergency ratings. However, when Eastlake 5 was modeled as in service and fully available in those simulations, all overloads above emergency limits were eliminated, even with the loss of Harding-Chamberlin.

Recommendation
23, page 160

Cause 2
Inadequate
Situational
Awareness

FE did not perform a contingency analysis after the loss of Eastlake 5 at 13:31 EDT to determine whether the loss of further lines or plants would put their system at risk. FE also did not perform a contingency analysis after the loss of Harding-Chamberlin at 15:05 EDT (in part because they did not know that it had tripped out of service), nor does the utility routinely conduct such studies.⁷ Thus FE did not discover that their system was no longer in an N-1

Figure 5.3. Eastlake Unit 5

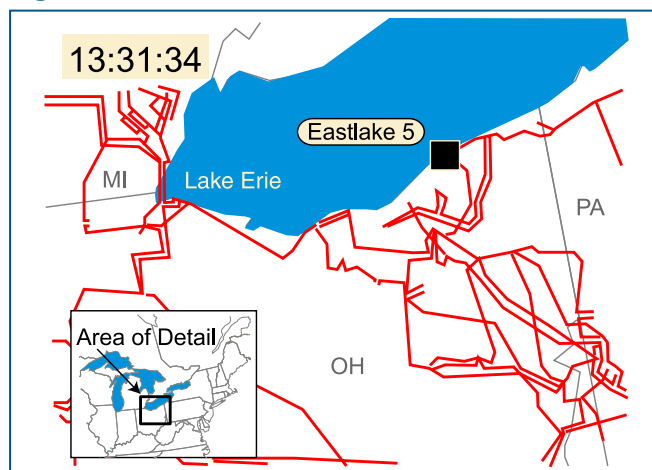

secure state at 15:05 EDT, and that operator action was needed to remedy the situation.

Recommendations
3, page 143, 22, page 159

1C) Stuart-Atlanta 345-kV Line Tripped: 14:02 EDT

Cause 1
Inadequate
System
Understanding

The Stuart-Atlanta 345-kV transmission line is in the control area of Dayton Power and Light. At 14:02 EDT the line tripped due to contact with a tree, causing a short circuit to ground, and locked out. Investigation team modeling reveals that the loss of DPL's Stuart-Atlanta line had no significant electrical

effect on power flows and voltages in the FE area. The team examined the security of FE's system, testing power flows and voltage levels with the combination of plant and line outages that evolved on the afternoon of August 14. This analysis shows that the availability or unavailability of the Stuart-Atlanta 345-kV line did not change the capability or performance of FE's system or affect any line loadings within the FE system, either immediately after its trip or later that afternoon. The only reason why Stuart-Atlanta matters to the blackout is because it contributed to the failure of MISO's state estimator to operate effectively, so MISO could not fully identify FE's precarious system conditions until 16:04 EDT.⁸

Data Exchanged for Operational Reliability

The topology of the electric system is essentially the road map of the grid. It is determined by how each generating unit and substation is connected to all other facilities in the system and at what voltage levels, the size of the individual transmission wires, the electrical characteristics of each of those connections, and where and when series and shunt reactive devices are in service. All of these elements affect the system's impedance—the physics of how and where power will flow across the system. Topology and impedance are modeled in power-flow programs, state estimators, and contingency analysis software used to evaluate and manage the system.

Topology processors are used as front-end processors for state estimators and operational display and alarm systems. They convert the digital telemetry of breaker and switch status to be used by state estimators, and for displays showing lines being opened or closed or reactive devices in or out of service.

A variety of up-to-date information on the elements of the system must be collected and exchanged for modeled topology to be accurate in real time. If data on the condition of system elements are incorrect, a state estimator will not successfully solve or converge because the real-world line flows and voltages being reported will disagree with the modeled solution.

Data Needed: A variety of operational data is collected and exchanged between control areas and reliability coordinators to monitor system performance, conduct reliability analyses, manage congestion, and perform energy accounting. The

data exchanged range from real-time system data, which is exchanged every 2 to 4 seconds, to OASIS reservations and electronic tags that identify individual energy transactions between parties. Much of these data are collected through operators' SCADA systems.

ICCP: Real-time operational data is exchanged and shared as rapidly as it is collected. The data is passed between the control centers using an Inter-Control Center Communications Protocol (ICCP), often over private frame relay networks. NERC operates one such network, known as NERCNet. ICCP data are used for minute-to-minute operations to monitor system conditions and control the system, and include items such as line flows, voltages, generation levels, dynamic interchange schedules, area control error (ACE), and system frequency, as well as in state estimators and contingency analysis tools.

IDC: Since the actual power flows along the path of least resistance in accordance with the laws of physics, the NERC Interchange Distribution Calculator (IDC) is used to determine where it will actually flow. The IDC is a computer software package that calculates the impacts of existing or proposed power transfers on the transmission components of the Eastern Interconnection. The IDC uses a power flow model of the interconnection, representing over 40,000 substation buses, 55,000 lines and transformers, and more than 6,000 generators. This model calculates transfer distribution factors (TDFs), which tell how a power transfer would load up each system

(continued on page 51)

Phase 2: FE's Computer Failures: 14:14 EDT to 15:59 EDT

Overview of This Phase

Starting around 14:14 EDT, FE's control room operators lost the alarm function that provided audible and visual indications when a significant piece of equipment changed from an acceptable to a problematic condition. Shortly thereafter, the EMS system lost a number of its remote control consoles. Next it lost the primary server computer

that was hosting the alarm function, and then the backup server such that all functions that were being supported on these servers were stopped at 14:54 EDT. However, for over an hour no one in FE's control room grasped that their computer systems were not operating properly, even though FE's Information Technology support staff knew of the problems and were working to solve them, and the absence of alarms and other symptoms offered many clues to the operators of the EMS system's impaired state. Thus, without a functioning EMS or the knowledge that it had failed, FE's system operators remained unaware that their electrical system condition was beginning to

Data Exchanged for Operational Reliability (Continued)

element, and outage transfer distribution factors (OTDFs), which tell how much power would be transferred to a system element if another specific system element were lost.

The IDC model is updated through the NERC System Data Exchange (SDX) system to reflect line outages, load levels, and generation outages. Power transfer information is input to the IDC through the NERC electronic tagging (E-Tag) system.

SDX: The IDC depends on element status information, exchanged over the NERC System Data Exchange (SDX) system, to keep the system topology current in its powerflow model of the Eastern Interconnection. The SDX distributes generation and transmission outage information to all operators, as well as demand and operating reserve projections for the next 48 hours. These data are used to update the IDC model, which is used to calculate the impact of power transfers across the system on individual transmission system elements. There is no current requirement for how quickly asset owners must report changes in element status (such as a line outage) to the SDX—some entities update it with facility status only once a day, while others submit new information immediately after an event occurs. NERC is now developing a requirement for regular information update submittals that is scheduled to take effect in the summer of 2004.

SDX data are used by some control centers to keep their topology up-to-date for areas of the interconnection that are not observable through direct telemetry or ICCP data. A number of transmission providers also use these data to update their transmission models for short-term

determination of available transmission capability (ATC).

E-Tags: All inter-control area power transfers are electronically tagged (E-Tag) with critical information for use in reliability coordination and congestion management systems, particularly the IDC in the Eastern Interconnection. The Western Interconnection also exchanges tagging information for reliability coordination and use in its unscheduled flow mitigation system. An E-Tag includes information about the size of the transfer, when it starts and stops, where it starts and ends, and the transmission service providers along its entire contract path, the priorities of the transmission service being used, and other pertinent details of the transaction. More than 100,000 E-Tags are exchanged every month, representing about 100,000 GWh of transactions. The information in the E-Tags is used to facilitate curtailments as needed for congestion management.

Voice Communications: Voice communication between control area operators and reliability is an essential part of exchanging operational data. When telemetry or electronic communications fail, some essential data values have to be manually entered into SCADA systems, state estimators, energy scheduling and accounting software, and contingency analysis systems. Direct voice contact between operators enables them to replace key data with readings from the other systems' telemetry, or surmise what an appropriate value for manual replacement should be. Also, when operators see spurious readings or suspicious flows, direct discussions with neighboring control centers can help avert problems like those experienced on August 14, 2003.

Figure 5.4. Timeline Phase 2

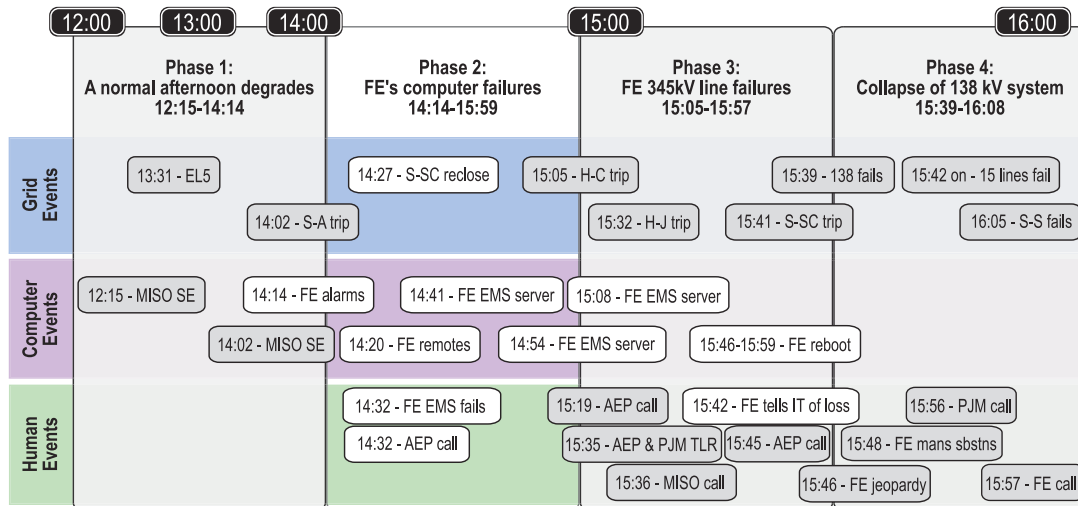

degrade. Unknowingly, they used the outdated system condition information they did have to discount information from others about growing system problems.

Key Events in This Phase

- 2A) 14:14 EDT: FE alarm and logging software failed. Neither FE’s control room operators nor FE’s IT EMS support personnel were aware of the alarm failure.
- 2B) 14:20 EDT: Several FE remote EMS consoles failed. FE’s Information Technology (IT) engineer was computer auto-paged.
- 2C) 14:27:16 EDT: Star-South Canton 345-kV transmission line tripped and successfully reclosed.
- 2D) 14:32 EDT: AEP called FE control room about AEP indication of Star-South Canton 345-kV line trip and reclosure. FE had no alarm or log of this line trip.
- 2E) 14:41 EDT: The primary FE control system server hosting the alarm function failed. Its applications and functions were passed over to a backup computer. FE’s IT engineer was auto-paged.
- 2F) 14:54 EDT: The FE back-up computer failed and all functions that were running on it stopped. FE’s IT engineer was auto-paged.

Failure of FE’s Alarm System

Cause 2
Inadequate Situational Awareness

FE’s computer SCADA alarm and logging software failed sometime shortly after 14:14 EDT (the last time that a valid alarm came in),

after voltages had begun deteriorating but well before any of FE’s lines began to contact trees and trip out. After that time, the FE control room consoles did not receive any further alarms, nor were there any alarms being printed or posted on the EMS’s alarm logging facilities. Power system operators rely heavily on audible and on-screen alarms, plus alarm logs, to reveal any significant changes in their system’s conditions. After 14:14 EDT on August 14, FE’s operators were working under a significant handicap without these tools. However, they were in further jeopardy because they did not know that they were operating without alarms, so that they did not realize that system conditions were changing.

Alarms are a critical function of an EMS, and EMS-generated alarms are the fundamental means by which system operators identify events on the power system that need their attention. Without alarms, events indicating one or more significant system changes can occur but remain undetected by the operator. If an EMS’s alarms are absent, but operators are aware of the situation and the remainder of the EMS’s functions are intact, the operators can potentially continue to use the EMS to monitor and exercise control of their power system. In such circumstances, the operators would have to do so via repetitive, continuous manual scanning of numerous data and status points located within the multitude of individual displays available within their EMS. Further, it would be difficult for the operator to identify quickly the most relevant of the many screens available.

In the same way that an alarm system can inform operators about the failure of key grid facilities, it

can also be set up to alarm them if the alarm system itself fails to perform properly. FE's EMS did not have such a notification system.

Although the alarm processing function of FE's EMS failed, the remainder of that system generally continued to collect valid real-time status information and measurements about FE's power system, and continued to have supervisory control over the FE system. The EMS also continued to send its normal and expected collection of information on to other monitoring points and authorities, including MISO and AEP. Thus these entities continued to receive accurate information about the status and condition of FE's power system after the time when FE's EMS alarms failed. FE's operators were unaware that in this situation they needed to manually and more closely monitor and interpret the SCADA information they were

receiving. Continuing on in the belief that their system was satisfactory, lacking any alarms from their EMS to the contrary, and without visualization aids such as a dynamic map board or a projection of system topology, FE control room operators were subsequently surprised when they began receiving telephone calls from other locations and information sources—MISO, AEP, PJM, and FE field operations staff—who offered information on the status of FE's transmission facilities that conflicted with FE's system operators' understanding of the situation.

Recommendations
3, page 143, 22, page 159

Analysis of the alarm problem performed by FE suggests that the alarm process essentially “stalled” while processing an alarm event, such that the process began to run in a manner that failed to complete the processing of that alarm or

Alarms

System operators must keep a close and constant watch on the multitude of things occurring simultaneously on their power system. These include the system's load, the generation and supply resources to meet that load, available reserves, and measurements of critical power system states, such as the voltage levels on the lines. Because it is not humanly possible to watch and understand all these events and conditions simultaneously, Energy Management Systems use alarms to bring relevant information to operators' attention. The alarms draw on the information collected by the SCADA real-time monitoring system.

Alarms are designed to quickly and appropriately attract the power system operators' attention to events or developments of interest on the system. They do so using combinations of audible and visual signals, such as sounds at operators' control desks and symbol or color changes or animations on system monitors, displays, or map boards. EMS alarms for power systems are similar to the indicator lights or warning bell tones that a modern automobile uses to signal its driver, like the “door open” bell, an image of a headlight high beam, a “parking brake on” indicator, and the visual and audible alert when a gas tank is almost empty.

Power systems, like cars, use “status” alarms and “limit” alarms. A status alarm indicates the state of a monitored device. In power systems these are commonly used to indicate whether such items as switches or breakers are “open” or

“closed” (off or on) when they should be otherwise, or whether they have changed condition since the last scan. These alarms should provide clear indication and notification to system operators of whether a given device is doing what they think it is, or what they want it to do—for instance, whether a given power line is connected to the system and moving power at a particular moment.

EMS limit alarms are designed to provide an indication to system operators when something important that is measured on a power system device—such as the voltage on a line or the amount of power flowing across it—is below or above pre-specified limits for using that device safely and efficiently. When a limit alarm activates, it provides an important early warning to the power system operator that elements of the system may need some adjustment to prevent damage to the system or to customer loads—like the “low fuel” or “high engine temperature” warnings in a car.

When FE's alarm system failed on August 14, its operators were running a complex power system without adequate indicators of when key elements of that system were reaching and passing the limits of safe operation—and without awareness that they were running the system without these alarms and should no longer assume that not getting alarms meant that system conditions were still safe and unchanging.

produce any other valid output (alarms). In the meantime, new inputs—system condition data that needed to be reviewed for possible alarms—built up in and then overflowed the process’ input buffers.^{9,10}

Loss of Remote EMS Terminals. Between 14:20 EDT and 14:25 EDT, some of FE’s remote EMS terminals in substations ceased operation. FE has advised the investigation team that it believes this occurred because the data feeding into those terminals started “queuing” and overloading the terminals’ buffers. FE’s system operators did not learn about this failure until 14:36 EDT, when a technician at one of the sites noticed the terminal was not working after he came in on the 15:00 shift, and called the main control room to report the problem. As remote terminals failed, each triggered an automatic page to FE’s Information Technology (IT) staff.¹¹ The investigation team has not determined why some terminals failed whereas others did not. Transcripts indicate that data links to the remote sites were down as well.¹²

EMS Server Failures. FE’s EMS system includes several server nodes that perform the higher functions of the EMS. Although any one of them can host all of the functions, FE’s normal system configuration is to have a number of host subsets of the applications, with one server remaining in a “hot-standby” mode as a backup to the others should any fail. At 14:41 EDT, the primary server hosting the EMS alarm processing application failed, due either to the stalling of the alarm application, “queuing” to the remote EMS terminals, or some combination of the two. Following pre-programmed instructions, the alarm system application and all other EMS software running on the first server automatically transferred (“failed-over”) onto the back-up server. However, because the alarm application moved intact onto the backup while still stalled and ineffective, the backup server failed 13 minutes later, at 14:54 EDT. Accordingly, all of the EMS applications on these two servers stopped running.

Recommendation
22, page 159

Cause 2
Inadequate
Situational
Awareness

The concurrent loss of both EMS servers apparently caused several new problems for FE’s EMS and the operators who used it. Tests run during FE’s after-the-fact analysis of the alarm failure event indicate that a concurrent absence of these servers can significantly slow down the rate at which the EMS system puts new—or refreshes existing—displays on

operators’ computer consoles. Thus at times on August 14th, operators’ screen refresh rates—the rate at which new information and displays are painted onto the computer screen, normally 1 to 3 seconds—slowed to as long as 59 seconds per screen. Since FE operators have numerous information screen options, and one or more screens are commonly “nested” as sub-screens to one or more top level screens, operators’ ability to view, understand and operate their system through the EMS would have slowed to a frustrating crawl.¹³ This situation may have occurred between 14:54 EDT and 15:08 EDT when both servers failed, and again between 15:46 EDT and 15:59 EDT while FE’s IT personnel attempted to reboot both servers to remedy the alarm problem.

Loss of the first server caused an auto-page to be issued to alert FE’s EMS IT support personnel to the problem. When the back-up server failed, it too sent an auto-page to FE’s IT staff. They did not notify control room operators of the problem. At 15:08 EDT, IT staffers completed a “warm reboot” (restart) of the primary server. Startup diagnostics monitored during that reboot verified that the computer and all expected processes were running; accordingly, FE’s IT staff believed that they had successfully restarted the node and all the processes it was hosting. However, although the server and its applications were again running, the alarm system remained frozen and non-functional, even on the restarted computer. The IT staff did not confirm that the alarm system was again working properly with the control room operators.

Recommendation
19, page 156

Another casualty of the loss of both servers was the Automatic Generation Control (AGC) function hosted on those computers. Loss of AGC meant that FE’s operators could not run affiliated power plants on pre-set programs to respond automatically to meet FE’s system load and interchange obligations. Although the AGC did not work from 14:54 EDT to 15:08 EDT and 15:46 EDT to 15:59 EDT (periods when both servers were down), this loss of function does not appear to have had an effect on the blackout.

Recommendation
22, page 159

Cause 2
Inadequate
Situational
Awareness

The concurrent loss of the EMS servers also caused the failure of FE’s strip chart function. There are many strip charts in the FE Reliability Operator control room driven by the EMS computers, showing a variety

of system conditions, including raw ACE (Area Control Error), FE system load, and Sammis-South Canton and South Canton-Star loading. These charts are visible in the reliability operator control room. The chart printers continued to scroll but because the underlying computer system was locked up the chart pens showed only the last valid measurement recorded, without any variation from that measurement as time progressed (i.e., the charts “flat-lined”). There is no indication that any operators noticed or reported the failed operation of the charts.¹⁴ The few charts fed by direct analog telemetry, rather than the EMS system, showed primarily frequency data, and remained available throughout the afternoon of August 14. These yield little useful system information for operational purposes.

FE’s Area Control Error (ACE), the primary control signal used to adjust generators and imports to match load obligations, did not function between 14:54 EDT and 15:08 EDT and later between 15:46

EDT and 15:59 EDT, when the two servers were down. This meant that generators were not controlled during these periods to meet FE’s load and interchange obligations (except from 15:00 EDT to 15:09 EDT when control was switched to a backup controller). There were no apparent negative consequences from this failure. It has not been established how loss of the primary generation control signal was identified or if any discussions occurred with respect to the computer system’s operational status.¹⁵

EMS System History. The EMS in service at FE’s Ohio control center is a GE Harris (now GE Network Systems) XA21 system. It was initially brought into service in 1995. Other than the application of minor software fixes or patches typically encountered in the ongoing maintenance and support of such a system, the last major updates or revisions to this EMS were implemented in 1998. On August 14 the system was not running the most current release of the XA21 software. FE had

Who Saw What?

What data and tools did others have to monitor the conditions on the FE system?

Midwest ISO (MISO), reliability coordinator for FE

Alarms: MISO received indications of breaker trips in FE that registered in MISO’s alarms; however, the alarms were missed. These alarms require a look-up to link the flagged breaker with the associated line or equipment and unless this line was specifically monitored, require another look-up to link the line to the monitored flowgate. MISO operators did not have the capability to click on the on-screen alarm indicator to display the underlying information.

Real Time Contingency Analysis (RTCA): The contingency analysis showed several hundred violations around 15:00 EDT. This included some FE violations, which MISO (FE’s reliability coordinator) operators discussed with PJM (AEP’s Reliability Coordinator).^a Simulations developed for this investigation show that violations for a contingency would have occurred after the Harding-Chamberlin trip at 15:05 EDT. There is no indication that MISO addressed this issue. It is not known whether MISO identified the developing Sammis-Star problem.

^a“MISO Site Visit,” Benbow interview.

^b“AEP Site Visit,” Ulrich interview.

^cExample at 14:35, Channel 4; 15:19, Channel 4; 15:45, Channel 14 (FE transcripts).

Flowgate Monitoring Tool: While an inaccuracy has been identified with regard to this tool it still functioned with reasonable accuracy and prompted MISO to call FE to discuss the Hanna-Juniper line problem. It would not have identified problems south of Star since that was not part of the flowgate and thus not modeled in MISO’s flowgate monitor.

AEP

Contingency Analysis: According to interviews,^b AEP had contingency analysis that covered lines into Star. The AEP operator identified a problem for Star-South Canton overloads for a Sammis-Star line loss about 15:33 EDT and asked PJM to develop TLRs for this. However, due to the size of the requested TLR, this was not implemented before the line tripped out of service.

Alarms: Since a number of lines cross between AEP’s and FE’s systems, they had the ability at their respective end of each line to identify contingencies that would affect both. AEP initially noticed FE line problems with the first and subsequent trips of the Star-South Canton 345-kV line, and called FE three times between 14:35 EDT and 15:45 EDT to determine whether FE knew the cause of the outage.^c

decided well before August 14 to replace it with one from another vendor.

Recommendation
33, page 164

FE personnel told the investigation team that the alarm processing application had failed on occasions prior to August 14, leading to loss of the alarming of system conditions and events for FE's operators.¹⁶ However, FE said that the mode and behavior of this particular failure event were both first time occurrences and ones which, at the time, FE's IT personnel neither recognized nor knew how to correct. FE staff told investigators that it was only during a post-outage support call with GE late on 14 August that FE and GE determined that the only available course of action to correct the alarm problem was a "cold reboot"¹⁷ of FE's overall XA21 system. In interviews immediately after the blackout, FE IT personnel indicated that they discussed a cold reboot of the XA21 system with control room operators after they were told of the alarm problem at 15:42 EDT, but decided not to take such action because operators considered power system conditions precarious, were concerned about the length of time that the reboot might take to complete, and understood that a cold reboot would leave them with even less EMS functionality until it was completed.¹⁸

Clues to the EMS Problems. There is an entry in FE's western desk operator's log at 14:14 EDT referring to the loss of alarms, but it is not clear whether that entry was made at that time or subsequently, referring back to the last known alarm. There is no indication that the operator mentioned the problem to other control room staff and supervisors or to FE's IT staff.

Recommendation
26, page 161

The first clear hint to FE control room staff of any computer problems occurred at 14:19 EDT when a caller and an FE control room operator discussed the fact that three sub-transmission center dial-ups had failed.¹⁹ At 14:25 EDT, a control room operator talked with a caller about the failure of these three remote EMS consoles.²⁰ The next hint came at 14:32 EDT, when FE scheduling staff spoke about having made schedule changes to update the EMS pages, but that the totals did not update.²¹

Cause 2
Inadequate
Situational
Awareness

Although FE's IT staff would have been aware that concurrent loss of its servers would mean the loss of alarm processing on the EMS, the investigation team has found no indication that the IT staff informed the control

room staff either when they began work on the servers at 14:54 EDT, or when they completed the primary server restart at 15:08 EDT. At 15:42 EDT, the IT staff were first told of the alarm problem by a control room operator; FE has stated to investigators that their IT staff had been unaware before then that the alarm processing sub-system of the EMS was not working.

Without the EMS systems, the only remaining ways to monitor system conditions would have been through telephone calls and direct analog telemetry. FE control room personnel did not realize that alarm processing on their EMS was not working and, subsequently, did not monitor other available telemetry.

Cause 2
Inadequate
Situational
Awareness

During the afternoon of August 14, FE operators talked to their field personnel, MISO, PJM (concerning an adjoining system in PJM's reliability coordination region), adjoining systems (such as AEP), and customers. The FE operators received pertinent information from all these sources, but did not recognize the emerging problems from the clues offered. This pertinent information included calls such as that from FE's eastern control center asking about possible line trips, FE Perry nuclear plant calls regarding what looked like nearby line trips, AEP calling about their end of the Star-South Canton line tripping, and MISO and PJM calling about possible line overloads.

Recommendations
19, page 156; 26, page 161

Without a functioning alarm system, the FE control area operators failed to detect the tripping of electrical facilities essential to maintain the security of their control area. Unaware of the loss of alarms and a limited EMS, they made no alternate arrangements to monitor the system. When AEP identified the 14:27 EDT circuit trip and reclosure of the Star 345 kV line circuit breakers at AEP's South Canton substation, the FE operator dismissed the information as either not accurate or not relevant to his system, without following up on the discrepancy between the AEP event and the information from his own tools. There was no subsequent verification of conditions with the MISO reliability coordinator.

Only after AEP notified FE that a 345-kV circuit had tripped and locked out did the FE control area operator compare this information to actual breaker conditions. FE failed to inform its reliability coordinator and adjacent control areas when they became aware that system conditions

had changed due to unscheduled equipment outages that might affect other control areas.

Recommendations
26, page 161; 30, page 163

Phase 3: Three FE 345-kV Transmission Line Failures and Many Phone Calls: 15:05 EDT to 15:57 EDT

Overview of This Phase

From 15:05:41 EDT to 15:41:35 EDT, three 345-kV lines failed with power flows at or below each transmission line's emergency rating. These line trips were not random. Rather, each was the result of a contact between a line and a tree that had grown so tall that, over a period of years, it encroached into the required clearance height for the line. As each line failed, its outage increased the loading on the remaining lines (Figure 5.5). As each of the transmission lines failed, and power flows shifted to other transmission paths, voltages on the rest of FE's system degraded further (Figure 5.6).

Key Phase 3 Events

- 3A) 15:05:41 EDT: Harding-Chamberlin 345-kV line tripped.
- 3B) 15:31-33 EDT: MISO called PJM to determine if PJM had seen the Stuart-Atlanta 345-kV line outage. PJM confirmed Stuart-Atlanta was out.
- 3C) 15:32:03 EDT: Hanna-Juniper 345-kV line tripped.

- 3D) 15:35 EDT: AEP asked PJM to begin work on a 350-MW TLR to relieve overloading on the Star-South Canton line, not knowing the Hanna-Juniper 345-kV line had already tripped at 15:32 EDT.
- 3E) 15:36 EDT: MISO called FE regarding post-contingency overload on Star-Juniper 345-kV line for the contingency loss of the Hanna-Juniper 345-kV line, unaware at the start of the call that Hanna-Juniper had already tripped.
- 3F) 15:41:33-41 EDT: Star-South Canton 345-kV tripped, reclosed, tripped again at 15:41:35 EDT and remained out of service, all while AEP and PJM were discussing TLR relief options (event 3D).

Transmission lines are designed with the expectation that they will sag lower when they become hotter. The transmission line gets hotter with heavier line loading and under higher ambient temperatures, so towers and conductors are designed to be tall enough and conductors pulled tightly enough to accommodate expected sagging and still meet safety requirements. On a summer day, conductor temperatures can rise from 60°C on mornings with average wind to 100°C with hot air temperatures and low wind conditions.

A short-circuit occurred on the Harding-Chamberlin 345-kV line due to a contact between the line conductor and a tree. This line failed with power flow at only 44% of its normal and emergency line rating. Incremental line current and temperature increases, escalated by the loss of Harding-Chamberlin, caused more sag on the Hanna-Juniper line, which contacted a tree and failed with power flow at 88% of its normal and emergency line rating. Star-South Canton

Figure 5.5. FirstEnergy 345-kV Line Flows

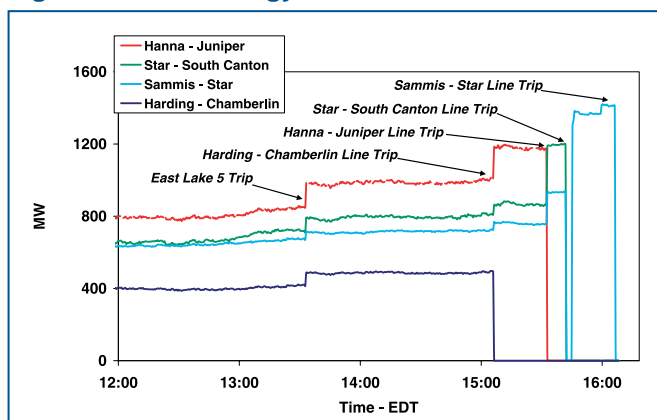

Figure 5.6. Voltages on FirstEnergy's 345-kV Lines: Impacts of Line Trips

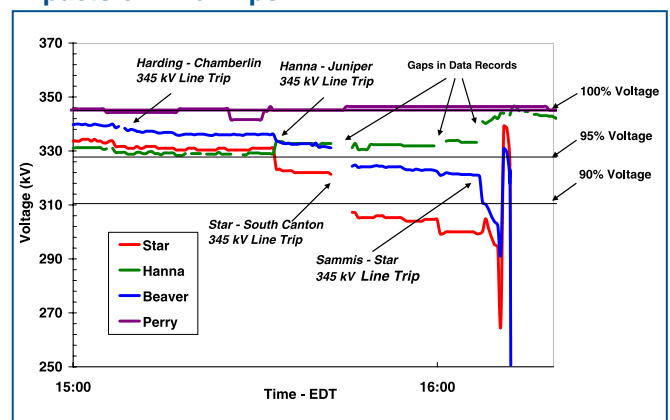
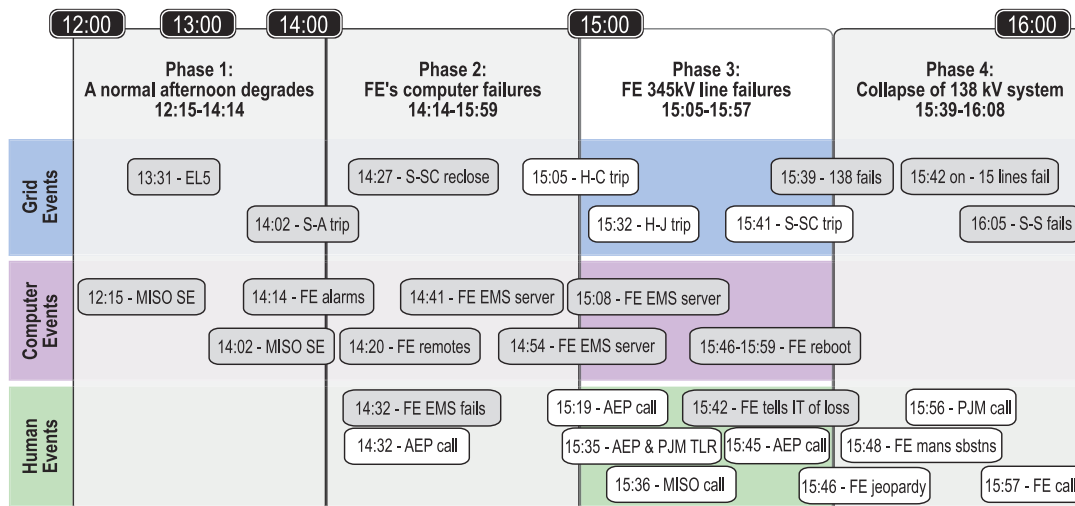

Figure 5.7. Timeline Phase 3



contacted a tree three times between 14:27:15 EDT and 15:41:33 EDT, opening and reclosing each time before finally locking out while loaded at 93% of its emergency rating at 15:41:35 EDT. Each of these three lines tripped not because of excessive sag due to overloading or high conductor temperature, but because it hit an overgrown, untrimmed tree.²²

Cause 3
Inadequate
Tree
Trimming

Overgrown trees, as opposed to excessive conductor sag, caused each of these faults. While sag may have contributed to these events, these incidents occurred because the trees grew too tall and encroached into the space below the line which is intended to be clear of any objects, not because the lines sagged into short trees. Because the trees were so tall (as discussed below), each of these lines faulted under system conditions well within specified operating parameters. The investigation team found field evidence of tree contact at all three locations, including human observation of the Hanna-Juniper contact. Evidence outlined below confirms that contact with trees caused the short circuits to ground that caused each line to trip out on August 14.

To be sure that the evidence of tree/line contacts and tree remains found at each site was linked to the events of August 14, the team looked at whether these lines had any prior history of outages in preceding months or years that might have resulted in the burn marks, debarking, and other vegetative evidence of line contacts. The record establishes that there were no prior sustained outages known to be caused by trees for these lines in 2001, 2002, and 2003.²³

Like most transmission owners, FE patrols its lines regularly, flying over each transmission line twice a year to check on the condition of the rights-of-way. Notes from fly-overs in 2001 and 2002 indicate that the examiners saw a significant number of trees and brush that needed clearing or

Line Ratings

A conductor's normal rating reflects how heavily the line can be loaded under routine operation and keep its internal temperature below a certain temperature (such as 90°C). A conductor's emergency rating is often set to allow higher-than-normal power flows, but to limit its internal temperature to a maximum temperature (such as 100°C) for no longer than a specified period, so that it does not sag too low or cause excessive damage to the conductor.

For three of the four 345-kV lines that failed, FE set the normal and emergency ratings at the same level. Many of FE's lines are limited by the maximum temperature capability of its terminal equipment, rather than by the maximum safe temperature for its conductors. In calculating summer emergency ampacity ratings for many of its lines, FE assumed 90°F (32°C) ambient air temperatures and 6.3 ft/sec (1.9 m/sec) wind speed,^a which is a relatively high wind speed assumption for favorable wind cooling. Actual temperature on August 14 was 87°F (31°C) but wind speed at certain locations in the Akron area was somewhere between 0 and 2 ft/sec (0.6 m/sec) after 15:00 EDT that afternoon.

^aFirstEnergy Transmission Planning Criteria (Revision 8), page 3.

trimming along many FE transmission lines. Notes from fly-overs in the spring of 2003 found fewer problems, suggesting that fly-overs do not allow effective identification of the distance between a tree and the line above it, and need to be supplemented with ground patrols.

Recommendations
16, page 154; 27, page 162

3A) FE's Harding-Chamberlin 345-kV Line Tripped: 15:05 EDT

At 15:05:41 EDT, FE's Harding-Chamberlin line (Figure 5.8) tripped and locked out while loaded at 44% of its normal and emergency rating. At this low loading, the line temperature would not exceed safe levels—even if still air meant there

Utility Vegetation Management: When Trees and Lines Contact

Vegetation management is critical to any utility company that maintains overhead energized lines. It is important and relevant to the August 14 events because electric power outages occur when trees, or portions of trees, grow up or fall into overhead electric power lines. While not all outages can be prevented (due to storms, heavy winds, etc.), some outages can be mitigated or prevented by managing the vegetation before it becomes a problem. When a tree contacts a power line it causes a short circuit, which is read by the line's relays as a ground fault. Direct physical contact is not necessary for a short circuit to occur. An electric arc can occur between a part of a tree and a nearby high-voltage conductor if a sufficient distance separating them is not maintained. Arcing distances vary based on such factors such as voltage and ambient wind and temperature conditions. Arcs can cause fires as well as short circuits and line outages.

Most utilities have right-of-way and easement agreements allowing them to clear and maintain vegetation as needed along their lines to provide safe and reliable electric power. Transmission easements generally give the utility a great deal of control over the landscape, with extensive rights to do whatever work is required to maintain the lines with adequate clearance through the control of vegetation. The three principal means of managing vegetation along a transmission right-of-way are pruning the limbs adjacent to the line clearance zone, removing vegetation completely by mowing or cutting, and using herbicides to retard or kill further growth. It is common to see more tree and brush removal using mechanical and chemical tools and relatively less pruning along transmission rights-of-way.

FE's easement agreements establish extensive rights regarding what can be pruned or removed

in these transmission rights-of-way, including: "the right to erect, inspect, operate, replace, relocate, repair, patrol and permanently maintain upon, over, under and along the above described right of way across said premises all necessary structures, wires, cables and other usual fixtures and appurtenances used for or in connection with the transmission and distribution of electric current, including telephone and telegraph, and the right to trim, cut, remove or control by any other means at any and all times such trees, limbs and underbrush within or adjacent to said right of way as may interfere with or endanger said structures, wires or appurtenances, or their operations."^a

FE uses a 5-year cycle for transmission line vegetation maintenance (i.e., it completes all required vegetation work within a 5-year period for all circuits). A 5-year cycle is consistent with industry practices, and it is common for transmission providers not to fully exercise their easement rights on transmission rights-of-way due to landowner or land manager opposition.

A detailed study prepared for this investigation, "Utility Vegetation Management Final Report," concludes that although FirstEnergy's vegetation management practices are within common or average industry practices, those common industry practices need significant improvement to assure greater transmission reliability.^b The report further recommends that strict regulatory oversight and support will be required for utilities to improve and sustain needed improvements in their vegetation management programs.

NERC has no standards or requirements for vegetation management or transmission right-of-way clearances, nor for the determination of line ratings.

^aStandard language in FE's right-of-way easement agreement.

^b"Utility Vegetation Management Final Report," CN Utility Consulting, March 2004.

Cause 3

Inadequate
Tree
Trimming

was no wind cooling of the conductor—and the line would not sag excessively. The investigation team examined the relay data for this trip, identified the geographic location of the fault, and determined that the relay data match the classic “signature” pattern for a tree/line short circuit to ground fault. The field team found the remains of trees and brush at the fault location determined from the relay data. At this location, conductor height measured 46 feet 7 inches (14.20 meters), while the height of the felled tree measured 42 feet (12.80 meters); however, portions of the tree had been removed from the site. This means that while it is difficult to determine the exact height of the line contact, the measured height is a minimum and the actual contact was likely 3 to 4 feet (0.9 to 1.2 meters) higher than estimated here. Burn marks were observed 35 feet 8 inches (10.87 meters) up the tree, and the crown of this tree was at least 6 feet (1.83 meters) taller than the observed burn marks. The tree showed evidence of fault current damage.²⁴

Recommendations

16, page 154; 27, page 162

When the Harding-Chamberlin line locked out, the loss of this 345-kV path caused the remaining three southern 345-kV lines into Cleveland to pick up more load, with Hanna-Juniper picking up the most. The Harding-Chamberlin outage also caused more power to flow through the underlying 138-kV system.

Cause 2

Inadequate
Situational
Awareness

MISO did not discover that Harding-Chamberlin had tripped until after the blackout, when MISO reviewed the breaker operation log that evening. FE indicates that it discovered the line was out while investigating system conditions in response to MISO’s call at 15:36 EDT, when MISO told FE that MISO’s flowgate monitoring tool showed a Star-Juniper line overload following a contingency loss of Hanna-Juniper;²⁵ however, the investigation team has found no evidence within the control room logs or transcripts to show that FE knew of the Harding-Chamberlin line failure until after the blackout.

Recommendation

22, page 159

Cause 4

Inadequate
RC Diagnostic
Support

Harding-Chamberlin was not one of the flowgates that MISO monitored as a key transmission location, so the reliability coordinator was unaware when FE’s first 345-kV line failed. Although MISO received

Figure 5.8. Harding-Chamberlin 345-kV Line

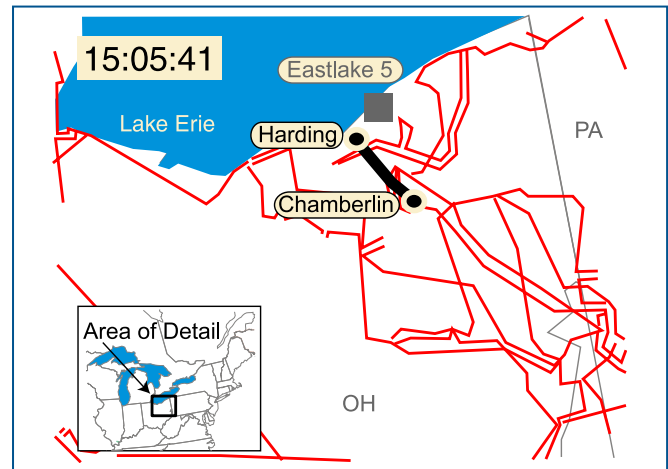

SCADA input of the line’s status change, this was presented to MISO operators as breaker status changes rather than a line failure. Because their EMS system topology processor had not yet been linked to recognize line failures, it did not connect the breaker information to the loss of a transmission line. Thus, MISO’s operators did not recognize the Harding-Chamberlin trip as a significant contingency event and could not advise FE regarding the event or its consequences. Further, without its state estimator and associated contingency analyses, MISO was unable to identify potential overloads that would occur due to various line or equipment outages. Accordingly, when the Harding-Chamberlin 345-kV line tripped at 15:05 EDT, the state estimator did not produce results and could not predict an overload if the Hanna-Juniper 345-kV line were to fail.

Recommendation

30, page 163

3C) FE’s Hanna-Juniper 345-kV Line Tripped: 15:32 EDT

Cause 3

Inadequate
Tree
Trimming

At 15:32:03 EDT the Hanna-Juniper line (Figure 5.9) tripped and locked out. A tree-trimming crew was working nearby and observed the tree/line contact. The tree contact occurred on the south phase, which is lower than the center phase due to construction design. Although little evidence remained of the tree during the field team’s visit in October, the team observed a tree stump 14 inches (35.5 cm) in diameter at its ground line and talked to an individual who witnessed the contact on August 14.²⁶ Photographs clearly indicate that the tree was of excessive height (Figure 5.10). Surrounding trees were 18 inches (45.7 cm) in diameter at ground line and 60 feet (18.3 meters) in

height (not near lines). Other sites at this location had numerous (at least 20) trees in this right-of-way.

Hanna-Juniper was loaded at 88% of its normal and emergency rating when it tripped. With this line open, over 1,200 MVA of power flow had to find a new path to reach its load in Cleveland. Loading on the remaining two 345-kV lines increased, with Star-Juniper taking the bulk of the power. This caused Star-South Canton's loading to rise above its normal but within its emergency rating and pushed more power onto the 138-kV system. Flows west into Michigan decreased slightly and voltages declined somewhat in the Cleveland area.

Figure 5.9. Hanna-Juniper 345-kV Line

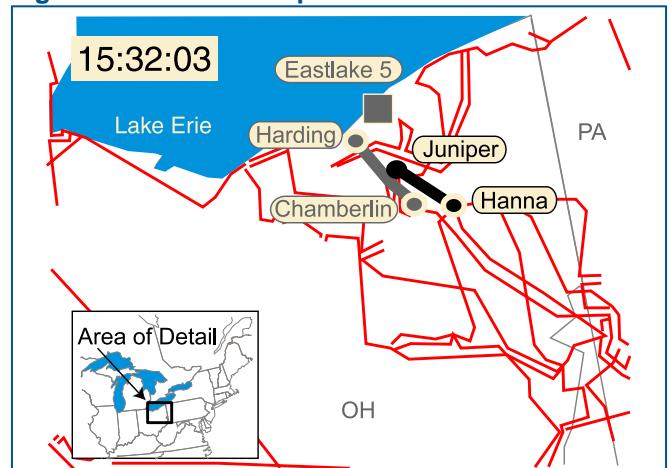

Why Did So Many Tree-to-Line Contacts Happen on August 14?

Tree-to-line contacts and resulting transmission outages are not unusual in the summer across much of North America. The phenomenon occurs because of a combination of events occurring particularly in late summer:

- ◆ Most tree growth occurs during the spring and summer months, so the later in the summer the taller the tree and the greater its potential to contact a nearby transmission line.
- ◆ As temperatures increase, customers use more air conditioning and load levels increase. Higher load levels increase flows on the transmission system, causing greater demands for both active power (MW) and reactive power (MVar). Higher flow on a transmission line causes the line to heat up, and the hot line sags lower because the hot conductor metal expands. Most emergency line ratings are set to limit conductors' internal temperatures to no more than 100°C (212°F).
- ◆ As temperatures increase, ambient air temperatures provide less cooling for loaded transmission lines.
- ◆ Wind flows cool transmission lines by increasing the airflow of moving air across the line. On August 14 wind speeds at the Ohio Akron-Fulton airport averaged 5 knots (1.5 m/sec) at around 14:00 EDT, but by 15:00 EDT wind speeds had fallen to 2 knots (0.6 m/sec)—the wind speed commonly assumed in conductor design—or lower. With lower winds, the lines sagged further and closer to any tree limbs near the lines.

This combination of events on August 14 across much of Ohio and Indiana caused transmission lines to heat and sag. If a tree had grown into a power line's designed clearance area, then a tree/line contact was more likely, though not inevitable. An outage on one line would increase power flows on related lines, causing them to be loaded higher, heat further, and sag lower.

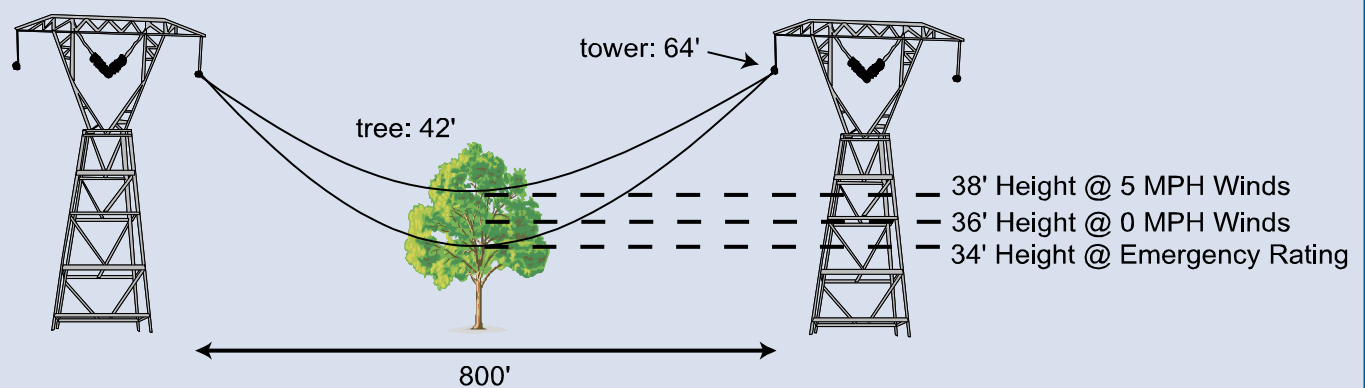

3D) AEP and PJM Begin Arranging a TLR for Star-South Canton: 15:35 EDT

Cause 4 Inadequate RC Diagnostic Support

Because its alarm system was not working, FE was not aware of the Harding-Chamberlin or Hanna-Juniper line trips. However, once MISO manually updated the state estimator model for the Stuart-Atlanta 345-kV line outage, the software successfully completed a state estimation and contingency analysis at 15:41 EDT. But this left a 36 minute period, from 15:05 EDT to 15:41 EDT, during which MISO did not recognize the consequences of the Hanna-Juniper loss, and FE operators knew neither of the line's loss nor its consequences. PJM and AEP recognized the overload on Star-South Canton, but had not expected it because their earlier contingency analysis did not examine enough lines within the FE system to foresee this result of the Hanna-Juniper contingency on top of the Harding-Chamberlin outage.

After AEP recognized the Star-South Canton overload, at 15:35 EDT AEP asked PJM to begin

developing a 350 MW TLR to mitigate it. The TLR was to relieve the actual overload above normal rating then occurring on Star-South Canton, and prevent an overload above emergency rating on

Figure 5.10. Cause of the Hanna-Juniper Line Loss



This August 14 photo shows the tree that caused the loss of the Hanna-Juniper line (tallest tree in photo). Other 345-kV conductors and shield wires can be seen in the background. Photo by Nelson Tree.

Handling Emergencies by Shedding Load and Arranging TLRs

Transmission loading problems. Problems such as contingent overloads of normal ratings are typically handled by arranging Transmission Loading Relief (TLR) measures, which in most cases take effect as a schedule change 30 to 60 minutes after they are issued. Apart from a TLR level 6, TLRs are intended as a tool to prevent the system from being operated in an unreliable state,^a and are not applicable in real-time emergency situations because it takes too long to implement reductions. Actual overloads and violations of stability limits need to be handled immediately under TLR level 4 or 6 by redispatching generation, system reconfiguration or tripping load. The dispatchers at FE, MISO and other control areas or reliability coordinators have authority—and under NERC operating policies, responsibility—to take such action, but the occasion to do so is relatively rare.

Lesser TLRs reduce scheduled transactions—non-firm first, then pro-rata between firm transactions, including flows that serve native load. When pre-contingent conditions are not solved with TLR levels 3 and 5, or conditions reach actual overloading or surpass stability limits, operators must use emergency generation

redispatch and/or load-shedding under TLR level 6 to return to a secure state. After a secure state is reached, TLR level 3 and/or 5 can be initiated to relieve the emergency generation redispatch or load-shedding activation.

System operators and reliability coordinators, by NERC policy, have the responsibility and the authority to take actions up to and including emergency generation redispatch and shedding firm load to preserve system security. On August 14, because they either did not know or understand enough about system conditions at the time, system operators at FE, MISO, PJM, or AEP did not call for emergency actions.

Use of automatic procedures in voltage-related emergencies. There are few automatic safety nets in place in northern Ohio except for under-frequency load-shedding in some locations. In some utility systems in the U.S. Northeast, Ontario, and parts of the Western Interconnection, special protection systems or remedial action schemes, such as under-voltage load-shedding are used to shed load under defined severe contingency conditions similar to those that occurred in northern Ohio on August 14.

^a“Northern MAPP/Northwestern Ontario Disturbance-June 25, 1998,” NERC 1998 Disturbance Report, page 17.

that line if the Sammis-Star line were to fail. But when they began working on the TLR, neither AEP nor PJM realized that the Hanna-Juniper 345-kV line had already tripped at 15:32 EDT, further degrading system conditions. Since the great majority of TLRs are for cuts of 25 to 50 MW, a 350 MW TLR request was highly unusual and operators were attempting to confirm why so much relief was suddenly required before implementing the requested TLR. Less than ten minutes elapsed between the loss of Hanna-Juniper, the overload above the normal limits of Star-South Canton, and the Star-South Canton trip and lock-out.

Recommendations
6, page 147; 22, page 159;
30, page 163; 31, page 163

Cause 2
Inadequate
Situational
Awareness

Unfortunately, neither AEP nor PJM recognized that even a 350 MW TLR on the Star-South Canton line would have had little impact on the overload. Investigation team analysis using the Interchange Distribution Calculator (which was fully available on the afternoon of August 14) indicates that tagged transactions for the 15:00 EDT hour across Ohio had minimal impact on the overloaded lines. As discussed in Chapter 4, this analysis showed that after the loss of the Hanna-Juniper 345 kV line, Star-South Canton was loaded primarily with flows to serve native and network loads, delivering makeup energy for the loss of Eastlake 5, purchased from PJM (342 MW) and Ameren (126 MW). The only way that these high loadings could have been relieved would not have been from the redispatch that AEP requested, but rather from significant load-shedding by FE in the Cleveland area.

Cause 4
Inadequate
RC Diagnostic
Support

The primary tool MISO uses for assessing reliability on key flowgates (specified groupings of transmission lines or equipment that sometimes have less transfer capability than desired) is the flowgate monitoring tool. After the Harding-Chamberlin 345-kV line outage at 15:05 EDT, the flowgate monitoring tool produced incorrect (obsolete) results, because the outage was not reflected in the model. As a result, the tool assumed that Harding-Chamberlin was still available and did not predict an overload for loss of the Hanna-Juniper 345-kV line. When Hanna-Juniper tripped at 15:32 EDT, the resulting overload was detected by MISO’s SCADA and set off alarms to MISO’s system operators, who then phoned FE about it.²⁷ Because both MISO’s state estimator and its flowgate monitoring tool

were not working properly, MISO’s ability to recognize FE’s evolving contingency situation was impaired.

Recommendations
22, page 159; 30, page 163

3F) Loss of the Star-South Canton 345-kV Line: 15:41 EDT

The Star-South Canton line (Figure 5.11) crosses the boundary between FE and AEP—each company owns the portion of the line and manages the right-of-way within its respective territory. The Star-South Canton line tripped and reclosed three times on the afternoon of August 14, first at 14:27:15 EDT while carrying less than 55% of its emergency rating (reclosing at both ends), then at 15:38:48 and again at 15:41:33 EDT. These multiple contacts had the effect of “electric tree-trimming,” burning back the contacting limbs temporarily and allowing the line to carry more current until further sag in the still air caused the final contact and lock-out. At 15:41:35 EDT the line tripped and locked out at the Star substation, with power flow at 93% of its emergency rating. A short-circuit to ground occurred in each case.

Cause 3
Inadequate
Tree
Trimming

The investigation’s field team inspected the right of way in the location indicated by the relay digital fault recorders, in the FE portion of the line. They found debris from trees and vegetation that had been felled. At this location the conductor height was 44 feet 9 inches (13.6 meters). The identifiable tree remains measured 30 feet (9.1 meters) in height, although the team could not verify the location of the stump, nor find all sections of the tree. A nearby cluster of trees showed significant fault damage, including charred limbs and de-barking from fault current. Further, topsoil in

Figure 5.11. Star-South Canton 345-kV Line

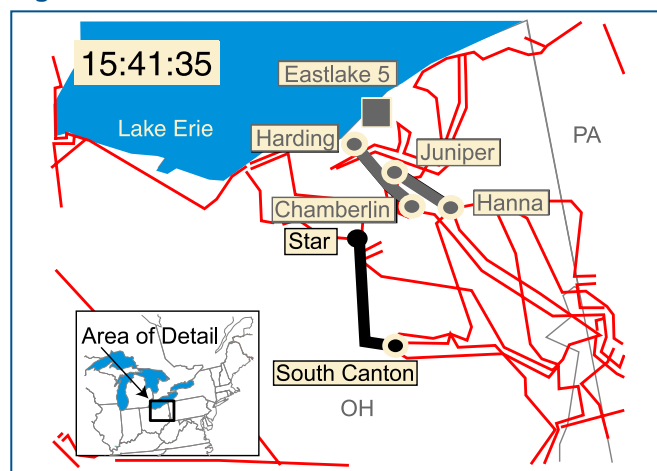

the area of the tree trunk was disturbed, discolored and broken up, a common indication of a higher magnitude fault or multiple faults. Analysis of another stump showed that a fourteen year-old tree had recently been removed from the middle of the right-of-way.²⁸

Recommendations
16, page 154; 27, page 162

After the Star-South Canton line was lost, flows increased greatly on the 138-kV system toward Cleveland and area voltage levels began to degrade on the 138-kV and 69-kV system. At the same time, power flows increased on the Sammis-Star 345-kV line due to the 138-kV line trips—the only remaining paths into Cleveland from the south.

Cause 2
Inadequate Situational Awareness

FE's operators were not aware that the system was operating outside first contingency limits after the Harding-Chamberlin trip (for the possible loss of Hanna-Juniper or the Perry unit), because they did not conduct a contingency analysis.²⁹ The investigation team has not determined whether the system status information used by FE's state estimator and contingency analysis model was being accurately updated.

Recommendation
22, page 159

Cause 1
Inadequate System Understanding

Load-Shed Analysis. The investigation team looked at whether it would have been possible to prevent the blackout by shedding load within the Cleveland-Akron area before the Star-South Canton 345 kV line tripped at 15:41 EDT. The team modeled the system assuming 500 MW of load shed within the Cleveland-Akron area before 15:41 EDT and found that this would have improved voltage at the Star bus from 91.7% up to 95.6%, pulling the line loading from 91 to 87% of its emergency ampere rating; an additional 500 MW of load would have had to be dropped to improve Star voltage to 96.6% and the line loading to 81% of its emergency ampere rating. But since the Star-South Canton line had already been compromised by the tree below it (which caused the first two trips and reclosures), and was about to trip from tree contact a third time, it is not clear that had such load shedding occurred, it would have prevented the ultimate trip and lock-out of the line. However, modeling indicates that this load shed would have prevented the subsequent tripping of the Sammis-Star line (see page 70).

Recommendations
8, page 147; 21, page 158

Cause 2
Inadequate Situational Awareness

System impacts of the 345-kV failures. According to extensive investigation team modeling, there were no contingency limit violations as of 15:05 EDT before

the loss of the Harding-Chamberlin 345-kV line. Figure 5.12 shows the line loadings estimated by investigation team modeling as the 345-kV lines in northeast Ohio began to trip. Showing line loadings on the 345-kV lines as a percent of normal rating, it tracks how the loading on each line increased as each subsequent 345-kV and 138-kV line tripped out of service between 15:05 EDT (Harding-Chamberlin, the first line above to stair-step down) and 16:06 EDT (Dale-West Canton). As the graph shows, none of the 345- or 138-kV lines exceeded their normal ratings until after the combined trips of Harding-Chamberlin and Hanna-Juniper. But immediately after the second line was lost, Star-South Canton's loading jumped from an estimated 82% of normal to 120% of normal (which was still below its emergency rating) and remained at the 120% level for 10 minutes before tripping out. To the right, the graph shows the effects of the 138-kV line failures (discussed in the next phase) upon the two remaining 345-kV lines—i.e., Sammis-Star's loading increased steadily above 100% with each succeeding 138-kV line lost.

Following the loss of the Harding-Chamberlin 345-kV line at 15:05 EDT, contingency limit violations existed for:

- ◆ The Star-Juniper 345-kV line, whose loadings would exceed emergency limits if the Hanna-Juniper 345-kV line were lost; and

Figure 5.12. Cumulative Effects of Sequential Outages on Remaining 345-kV Lines

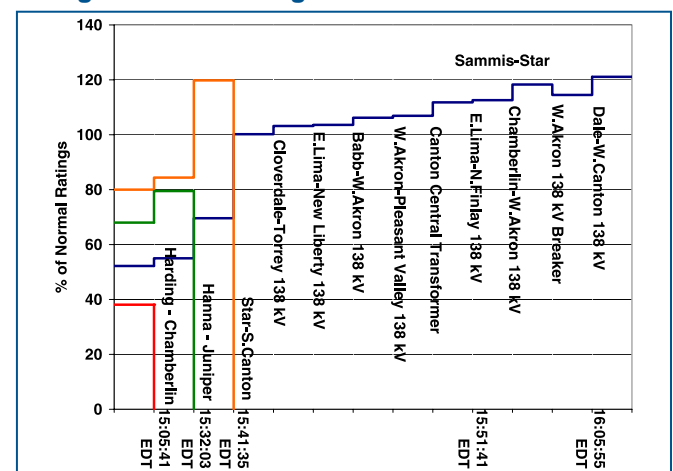

- ◆ The Hanna-Juniper and Harding-Juniper 345-kV lines, whose loadings would exceed emergency limits if the Perry generation unit (1,255 MW) were lost.

Operationally, once FE’s system entered an N-1 contingency violation state, any facility loss beyond that pushed them farther into violation and into a more unreliable state. After loss of the Harding-Chamberlin line, to avoid violating NERC criteria, FE needed to reduce loading on these three lines within 30 minutes such that no single contingency would violate an emergency limit; that is, to restore the system to a reliable operating mode.

Phone Calls into the FE Control Room

Cause 2 Inadequate Situational Awareness

Beginning at 14:14 EDT when their EMS alarms failed, and until at least 15:42 EDT when they began to recognize their situation, FE operators did not understand

how much of their system was being lost, and did not realize the degree to which their perception of their system was in error versus true system conditions, despite receiving clues via phone calls from AEP, PJM and MISO, and customers. The FE operators were not aware of line outages that occurred after the trip of Eastlake 5 at 13:31 EDT until approximately 15:45 EDT, although they were beginning to get external input describing aspects of the system’s weakening condition. Since FE’s operators were not aware and did not recognize events as they were occurring, they took no actions to return the system to a reliable state.

Recommendations 19, page 156; 26, page 161

A brief description follows of some of the calls FE operators received concerning system problems and their failure to recognize that the problem was on their system. For ease of presentation, this set of calls extends past the time of the 345-kV line trips into the time covered in the next phase, when the 138-kV system collapsed.

Following the first trip of the Star-South Canton 345-kV line at 14:27 EDT, AEP called FE at 14:32 EDT to discuss the trip and reclose of the line. AEP was aware of breaker operations at their end (South Canton) and asked about operations at FE’s Star end. FE indicated they had seen nothing at their end of the line, but AEP reiterated that the trip occurred at 14:27 EDT and that the South Canton breakers had reclosed successfully.³⁰ There was an internal FE conversation about the AEP

call at 14:51 EDT, expressing concern that they had not seen any indication of an operation, but lacking evidence within their control room, the FE operators did not pursue the issue.

At 15:19 EDT, AEP called FE back to confirm that the Star-South Canton trip had occurred and that AEP had a confirmed relay operation from the site. FE’s operator restated that because they had received no trouble or alarms, they saw no problem. An AEP technician at the South Canton substation verified the trip. At 15:20 EDT, AEP decided to treat the South Canton digital fault recorder and relay target information as a “fluke,” and checked the carrier relays to determine what the problem might be.³¹

At 15:35 EDT the FE control center received a call from the Mansfield 2 plant operator concerned about generator fault recorder triggers and excitation voltage spikes with an alarm for over-excitation, and a dispatcher called reporting a “bump” on their system. Soon after this call, FE’s Reading, Pennsylvania control center called reporting that fault recorders in the Erie west and south areas had activated, wondering if something had happened in the Ashtabula-Perry area. The Perry nuclear plant operator called to report a “spike” on the unit’s main transformer. When he went to look at the metering it was “still bouncing around pretty good. I’ve got it relay tripped up here . . . so I know something ain’t right.”³²

Beginning at this time, the FE operators began to think that something was wrong, but did not recognize that it was on their system. “It’s got to be in distribution, or something like that, or somebody else’s problem . . . but I’m not showing anything.”³³ Unlike many other transmission grid control rooms, FE’s control center did not have a map board (which shows schematically all major lines and plants in the control area on the wall in front of the operators), which might have shown the location of significant line and facility outages within the control area.

Recommendation 22, page 159

At 15:36 EDT, MISO contacted FE regarding the post-contingency overload on Star-Juniper for the loss of the Hanna-Juniper 345-kV line.³⁴

At 15:42 EDT, FE’s western transmission operator informed FE’s IT staff that the EMS system functionality was compromised. “Nothing seems to be updating on the computers . . . We’ve had people calling and reporting trips and nothing seems to be updating in the event summary . . . I think we’ve

got something seriously sick.” This is the first evidence that a member of FE’s control room staff recognized any aspect of their degraded EMS system. There is no indication that he informed any of the other operators at this moment. However, FE’s IT staff discussed the subsequent EMS alarm corrective action with some control room staff shortly thereafter.

Also at 15:42 EDT, the Perry plant operator called back with more evidence of problems. “I’m still getting a lot of voltage spikes and swings on the generator . . . I don’t know how much longer we’re going to survive.”³⁵

At 15:45 EDT, the tree trimming crew reported that they had witnessed a tree-caused fault on the Eastlake-Juniper 345-kV line; however, the actual fault was on the Hanna-Juniper 345-kV line in the same vicinity. This information added to the confusion in the FE control room, because the operator had indication of flow on the Eastlake-Juniper line.³⁶

After the Star-South Canton 345-kV line tripped a third time and locked out at 15:41:35 EDT, AEP called FE at 15:45 EDT to discuss and inform them that they had additional lines that showed overload. FE recognized then that the Star breakers had tripped and remained open.³⁷

At 15:46 EDT the Perry plant operator called the FE control room a third time to say that the unit was close to tripping off: “It’s not looking good . . . We ain’t going to be here much longer and you’re going to have a bigger problem.”³⁸

At 15:48 EDT, an FE transmission operator sent staff to man the Star substation, and then at 15:50 EDT, requested staffing at the regions, beginning with Beaver, then East Springfield.³⁹

At 15:48 EDT, PJM called MISO to report the Star-South Canton trip, but the two reliability coordinators’ measures of the resulting line flows on FE’s Sammis-Star 345-kV line did not match, causing them to wonder whether the Star-South Canton 345-kV line had returned to service.⁴⁰

At 15:56 EDT, because PJM was still concerned about the impact of the Star-South Canton trip, PJM called FE to report that Star-South Canton had tripped and that PJM thought FE’s Sammis-Star line was in actual emergency limit overload.⁴¹ FE could not confirm this overload. FE informed PJM that Hanna-Juniper was also out service. FE believed that the problems existed beyond their system. “AEP must have lost some major stuff.”⁴²

Emergency Action

For FirstEnergy, as with many utilities, emergency awareness is often focused on energy shortages. Utilities have plans to reduce loads under these circumstances to increasingly greater degrees. Tools include calling for contracted customer load reductions, then public appeals, voltage reductions, and finally shedding system load by cutting off interruptible and firm customers. FE has a plan for this that is updated yearly. While they can trip loads quickly where there is SCADA control of load breakers (although FE has few of these), from an energy point of view, the intent is to be able to regularly rotate what loads are not being served, which requires calling personnel out to switch the various groupings in and out. This event was not, however, a capacity or energy emergency or system instability, but an emergency due to transmission line overloads.

To handle an emergency effectively a dispatcher must first identify the emergency situation and then determine effective action. AEP identified potential contingency overloads at 15:36 EDT and called PJM even as Star-South Canton, one of the AEP/FE lines they were discussing, tripped and pushed FE’s Sammis-Star 345-kV line to its emergency rating. Since they had been focused on the impact of a Sammis-Star loss overloading Star-South Canton, they recognized that a serious problem had arisen on the system for which they did not have a ready solution. Later, around 15:50 EDT, their conversation reflected emergency conditions (138-kV lines were tripping and several other lines overloaded) but they still found no practical way to mitigate these overloads across utility and reliability coordinator boundaries.

Recommendation
20, page 158

Cause 2
Inadequate
Situational
Awareness

At the control area level, FE remained unaware of the precarious condition its system was in, with key lines out of service, degrading voltages, and severe overloads on their remaining lines. Transcripts show that FE operators were aware of falling voltages and customer problems after loss of the Hanna-Juniper 345-kV line (at 15:32 EDT). They called out personnel to staff substations because they did not think they could see them with their data gathering tools. They were also talking to customers. But there is no indication that FE’s operators clearly identified their situation as a possible emergency until around 15:45 EDT when the shift

supervisor informed his manager that it looked as if they were losing the system; even then, although FE had grasped that its system was in trouble, it never officially declared that it was an emergency condition and that emergency or extraordinary action was needed.

FE's internal control room procedures and protocols did not prepare it adequately to identify and react to the August 14 emergency. Throughout the afternoon of August 14 there were many clues that FE had lost both its critical monitoring alarm functionality and that its transmission system's reliability was becoming progressively more compromised. However, FE did not fully piece these clues together until after it had already lost critical elements of its transmission system and only minutes before subsequent trips triggered the cascade phase of the blackout. The clues to a compromised EMS alarm system and transmission system came into the FE control room from FE customers, generators, AEP, MISO, and PJM. In spite of these clues, because of a number of related factors, FE failed to identify the emergency that it faced.

Recommendations
20, page 158; 22, page 159;
26, page 161

Cause 2
Inadequate
Situational
Awareness

The most critical factor delaying the assessment and synthesis of the clues was a lack of information sharing between the FE system operators. In interviews with the FE operators and analysis of phone transcripts, it is evident that rarely were any of the critical clues shared with fellow operators. This lack of information sharing can be attributed to:

Recommendation
26, page 161

1. Physical separation of operators (the reliability operator responsible for voltage schedules was across the hall from the transmission operators).
2. The lack of a shared electronic log (visible to all), as compared to FE's practice of separate hand-written logs.⁴³
3. Lack of systematic procedures to brief incoming staff at shift change times.
4. Infrequent training of operators in emergency scenarios, identification and resolution of bad data, and the importance of sharing key information throughout the control room.

FE has specific written procedures and plans for dealing with resource deficiencies, voltage depressions, and overloads, and these include

instructions to adjust generators and trip firm loads. After the loss of the Star-South Canton line, voltages were below limits, and there were severe line overloads. But FE did not follow any of these procedures on August 14, because FE did not know for most of that time that its system might need such treatment.

What training did the operators and reliability coordinators have for recognizing and responding to emergencies? FE relied upon on-the-job experience as training for its operators in handling the routine business of a normal day, but had never experienced a major disturbance and had no simulator training or formal preparation for recognizing and responding to emergencies. Although all affected FE and MISO operators were NERC-certified, NERC certification of operators addresses basic operational considerations but offers little insight into emergency operations issues. Neither group of operators had significant training, documentation, or actual experience for how to handle an emergency of this type and magnitude.

Recommendation
20, page 158

Cause 4
Inadequate
RC Diagnostic
Support

MISO was hindered because it lacked clear visibility, responsibility, authority, and ability to take the actions needed in this circumstance. MISO had interpretive and operational tools and a large amount of system data, but had a limited view of FE's system. In MISO's function as FE's reliability coordinator, its primary task was to initiate and implement TLRs, recognize and solve congestion problems in less dramatic reliability circumstances with longer solution time periods than those which existed on August 14, and provide assistance as requested.

Throughout August 14, most major elements of FE's EMS were working properly. The system was automatically transferring accurate real-time information about FE's system conditions to computers at AEP, MISO, and PJM. FE's operators did not believe the transmission line failures reported by AEP and MISO were real until 15:42 EDT, after FE conversations with the AEP and MISO control rooms and calls from FE IT staff to report the failure of their alarms. At that point in time, FE operators began to think that their system might be in jeopardy—but they did not act to restore any of the lost transmission lines, clearly alert their reliability coordinator or neighbors about their situation, or take other possible remedial measures (such as load-shedding) to stabilize their system.

Figure 5.13. Timeline Phase 4

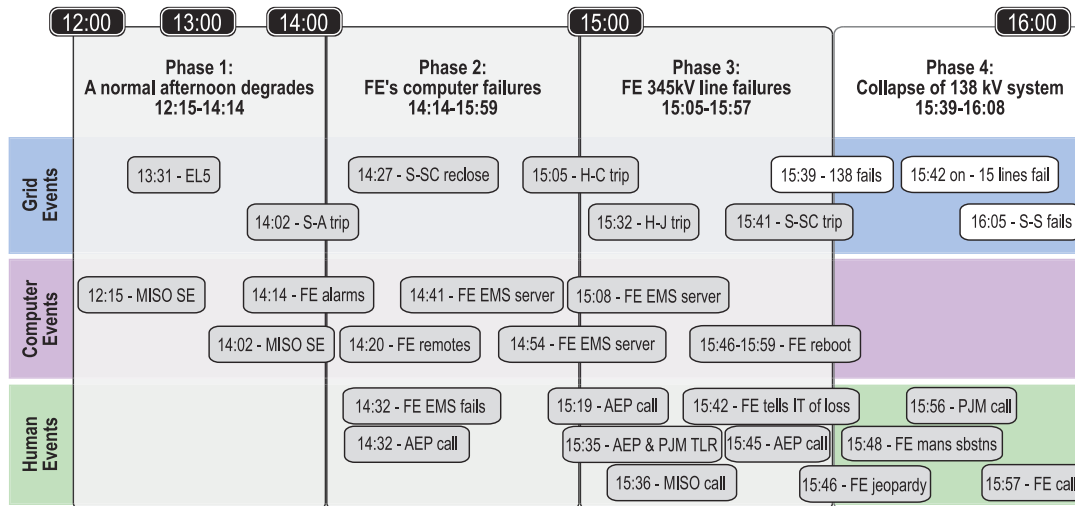

Phase 4: 138-kV Transmission System Collapse in Northern Ohio: 15:39 to 16:08 EDT

Overview of This Phase

As each of FE's 345-kV lines in the Cleveland area tripped out, it increased loading and decreased voltage on the underlying 138-kV system serving Cleveland and Akron, pushing those lines into overload. Starting at 15:39 EDT, the first of an eventual sixteen 138-kV lines began to fail (Figure 5.13). Relay data indicate that each of these lines eventually ground faulted, which indicates that it sagged low enough to contact something below the line.

Figure 5.14 shows how actual voltages declined at key 138-kV buses as the 345- and 138-kV lines were lost. As these lines failed, the voltage drops caused a number of large industrial customers with voltage-sensitive equipment to go off-line automatically to protect their operations. As the 138-kV lines opened, they blacked out customers in Akron and the areas west and south of the city, ultimately dropping about 600 MW of load.

Key Phase 4 Events

Between 15:39 EDT and 15:58:47 EDT seven 138-kV lines tripped:

- 4A) 15:39:17 EDT: Pleasant Valley-West Akron 138-kV line tripped and reclosed at both ends after sagging into an underlying distribution line.

- 15:42:05 EDT: Pleasant Valley-West Akron 138-kV West line tripped and reclosed.
- 15:44:40 EDT: Pleasant Valley-West Akron 138-kV West line tripped and locked out.
- 4B) 15:42:49 EDT: Canton Central-Cloverdale 138-kV line tripped on fault and reclosed.
- 15:45:39 EDT: Canton Central-Cloverdale 138-kV line tripped on fault and locked out.
- 4C) 15:42:53 EDT: Cloverdale-Torrey 138-kV line tripped.
- 4D) 15:44:12 EDT: East Lima-New Liberty 138-kV line tripped from sagging into an underlying distribution line.
- 4E) 15:44:32 EDT: Babb-West Akron 138-kV line tripped on ground fault and locked out.
- 4F) 15:45:40 EDT: Canton Central 345/138 kV transformer tripped and locked out due to 138 kV circuit breaker operating multiple times,

Figure 5.14. Voltages on FirstEnergy's 138-kV Lines: Impact of Line Trips

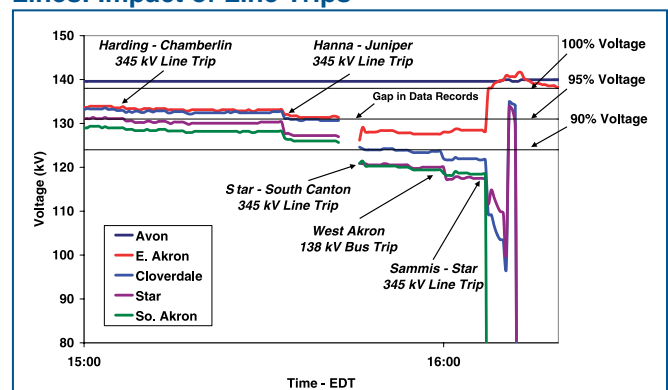

which then opened the line to FE's Cloverdale station.

4G) 15:51:41 EDT: East Lima-N. Findlay 138-kV line tripped, likely due to sagging line, and reclosed at East Lima end only.

4H) 15:58:47 EDT: Chamberlin-West Akron 138-kV line tripped.

Note: 15:51:41 EDT: Fostoria Central-N. Findlay 138-kV line tripped and reclosed, but never locked out.

At 15:59:00 EDT, the loss of the West Akron bus tripped due to breaker failure, causing another five 138-kV lines to trip:

4I) 15:59:00 EDT: West Akron 138-kV bus tripped, and cleared bus section circuit breakers at West Akron 138 kV.

4J) 15:59:00 EDT: West Akron-Aetna 138-kV line opened.

4K) 15:59:00 EDT: Barberton 138-kV line opened at West Akron end only. West Akron-B18 138-kV tie breaker opened, affecting West Akron 138/12-kV transformers #3, 4 and 5 fed from Barberton.

4L) 15:59:00 EDT: West Akron-Granger-Stoney-Brunswick-West Medina opened.

4M) 15:59:00 EDT: West Akron-Pleasant Valley 138-kV East line (Q-22) opened.

4N) 15:59:00 EDT: West Akron-Rosemont-Pine-Wadsworth 138-kV line opened.

From 16:00 EDT to 16:08:59 EDT, four 138-kV lines tripped, and the Sammis-Star 345-kV line tripped due to high current and low voltage:

4O) 16:05:55 EDT: Dale-West Canton 138-kV line tripped due to sag into a tree, reclosed at West Canton only

4P) 16:05:57 EDT: Sammis-Star 345-kV line tripped

4Q) 16:06:02 EDT: Star-Urban 138-kV line tripped

4R) 16:06:09 EDT: Richland-Ridgeville-Napoleon-Stryker 138-kV line tripped on overload and locked out at all terminals

4S) 16:08:58 EDT: Ohio Central-Wooster 138-kV line tripped

Note: 16:08:55 EDT: East Wooster-South Canton 138-kV line tripped, but successful automatic reclosing restored this line.

4A-H) Pleasant Valley to Chamberlin-West Akron Line Outages

From 15:39 EDT to 15:58:47 EDT, seven 138-kV lines in northern Ohio tripped and locked out. At 15:45:41 EDT, Canton Central-Tidd 345-kV line tripped and reclosed at 15:46:29 EDT because Canton Central 345/138-kV CB "A1" operated multiple times, causing a low air pressure problem that inhibited circuit breaker tripping. This event forced the Canton Central 345/138-kV transformers to disconnect and remain out of service, further weakening the Canton-Akron area 138-kV transmission system. At 15:58:47 EDT the Chamberlin-West Akron 138-kV line tripped.

4I-N) West Akron Transformer Circuit Breaker Failure and Line Outages

At 15:59 EDT FE's West Akron 138-kV bus tripped due to a circuit breaker failure on West Akron transformer #1. This caused the five remaining 138-kV lines connected to the West Akron substation to open. The West Akron 138/12-kV transformers remained connected to the Barberton-West Akron 138-kV line, but power flow to West Akron 138/69-kV transformer #1 was interrupted.

4O-P) Dale-West Canton 138-kV and Sammis-Star 345-kV Lines Tripped

After the Cloverdale-Torrey line failed at 15:42 EDT, Dale-West Canton was the most heavily loaded line on FE's system. It held on, although heavily overloaded to 160 and 180% of normal ratings, until tripping at 16:05:55 EDT. The loss of this line had a significant effect on the area, and voltages dropped significantly. More power shifted back to the remaining 345-kV network, pushing Sammis-Star's loading above 120% of rating. Two seconds later, at 16:05:57 EDT, Sammis-Star tripped out. Unlike the previous three 345-kV lines, which tripped on short circuits to ground due to tree contacts, Sammis-Star tripped because its protective relays saw low apparent impedance (depressed voltage divided by abnormally high line current)—i.e., the relay reacted as if the high flow was due to a short circuit. Although three more 138-kV lines dropped quickly in Ohio following the Sammis-Star trip, loss of the Sammis-Star line marked the turning point at which system problems in northeast Ohio initiated a cascading blackout across the northeast United States and Ontario.

Losing the 138-kV Transmission Lines

The tripping of 138-kV transmission lines that began at 15:39 EDT occurred because the loss

Cause 1
Inadequate System Understanding

of the combination of the Harding-Chamberlin, Hanna-Juniper and Star-South Canton 345-kV lines overloaded the 138-kV system with electricity flowing north

toward the Akron and Cleveland loads. Modeling indicates that the return of either the Hanna-Juniper or Chamberlin-Harding 345-kV lines would have diminished, but not alleviated, all of the 138-kV overloads. In theory, the return of both lines would have restored all the 138-kV lines to within their emergency ratings.

Cause 2
Inadequate Situational Awareness

However, all three 345-kV lines had already been compromised due to tree contacts so it is unlikely that FE would have successfully restored either line had

they known it had tripped out, and since Star-South Canton had already tripped and reclosed three times it is also unlikely that an operator knowing this would have trusted it to operate securely under emergency conditions. While generation redispatch scenarios alone would not have solved the overload problem, modeling indicates that shedding load in the Cleveland and Akron areas may have reduced most line loadings to within emergency range and helped stabilize the system. However, the amount of load shedding required grew rapidly as FE's system unraveled.

Preventing the Blackout with Load-Shedding

Cause 1
Inadequate System Understanding

The investigation team examined whether load shedding before the loss of the Sammis-Star 345-kV line at 16:05:57 EDT could have prevented this line loss. The team

found that 1,500 MW of load would have had to be

Figure 5.15. Simulated Effect of Prior Outages on 138-kV Line Loadings

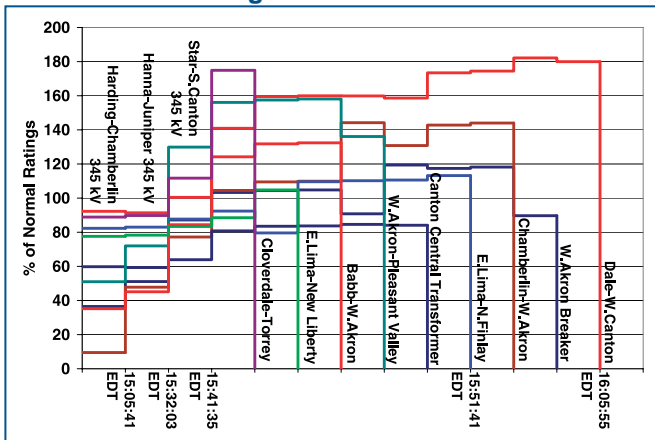

dropped within the Cleveland-Akron area to restore voltage at the Star bus from 90.8% (at 120% of normal and emergency ampere rating) up to 95.9% (at 101% of normal and emergency ampere rating).⁴⁴ The P-V and V-Q analysis reviewed in Chapter 4 indicated that 95% is the minimum operating voltage appropriate for 345-kV buses in the Cleveland-Akron area. The investigation team concluded that since the Sammis-Star 345 kV outage was the critical event leading to widespread cascading in Ohio and beyond, if manual or automatic load-shedding of 1,500 MW had occurred within the Cleveland-Akron area before that outage, the blackout could have been averted.

Recommendations
8, page 147; 21, page 158; 23, page 160

Loss of the Sammis-Star 345-kV Line

Figure 5.15, derived from investigation team modeling, shows how the power flows shifted across FE's 345- and key 138-kV northeast Ohio lines as the line failures progressed. All lines were loaded within normal limits after the Harding-Chamberlin lock-out, but after the Hanna-Juniper trip at 15:32 EDT, the Star-South Canton 345-kV line and three 138-kV lines jumped above normal loadings. After Star-South Canton locked out at 15:41 EDT within its emergency rating, five 138-kV and the Sammis-Star 345-kV lines were overloaded. From that point, as the graph shows, each subsequent line loss increased loadings on other lines, some loading to well over 150% of normal ratings before they failed. The Sammis-Star 345-kV line stayed in service until it tripped at 16:05:57 EDT.

FirstEnergy had no automatic load-shedding schemes in place, and did not attempt to begin manual load-shedding. As Chapters 4 and 5 have established, once Sammis-Star tripped, the possibility of averting the coming cascade by shedding load ended. Within 6 minutes of these overloads, extremely low voltages, big power swings and accelerated line tripping would cause separations and blackout within the Eastern Interconnection.

Recommendation
21, page 158

Endnotes

- Investigation team field visit to FE 10/8/2003: Steve Morgan.
- Investigation team field visit to FE, September 3, 2003, Hough interview: "When asked whether the voltages seemed unusual, he said that some sagging would be expected on a hot day, but on August 14th the voltages did seem unusually low." Spidle interview: "The voltages for the day were not particularly bad."

³ Manual of Operations, valid as of March 3, 2003, Process flowcharts: Voltage Control and Reactive Support – Plant and System Voltage Monitoring Under Normal Conditions.

⁴ 14:13:18. Channel 16 - Sammis 1. 13:15:49 / Channel 16 – West Lorain (FE Reliability Operator (RO) says, “Thanks. We’re starting to sag all over the system.”) / 13:16:44. Channel 16 – Eastlake (talked to two operators) (RO says, “We got a way bigger load than we thought we would have.” And “...So we’re starting to sag all over the system.”) / 13:20:22. Channel 16 – RO to “Berger” / 13:22:07. Channel 16 – “control room” RO says, “We’re sagging all over the system. I need some help.” / 13:23:24. Channel 16 – “Control room, Tom” / 13:24:38. Channel 16 – “Unit 9” / 13:26:04. Channel 16 – “Dave” / 13:28:40. Channel 16 “Troy Control.” Also general note in RO Dispatch Log.

⁵ Example at 13:33:40, Channel 3, FE transcripts.

⁶ Investigation team field visit to MISO, Walsh and Seidu interviews.

⁷ FE had and ran a state estimator every 30 minutes. This served as a base from which to perform contingency analyses. FE’s contingency analysis tool used SCADA and EMS inputs to identify any potential overloads that could result from various line or equipment outages. FE indicated that it has experienced problems with the automatic contingency analysis operation since the system was installed in 1995. As a result, FE operators or engineers ran contingency analysis manually rather than automatically, and were expected to do so when there were questions about the state of the system. Investigation team interviews of FE personnel indicate that the contingency analysis model was likely running but not consulted at any point in the afternoon of August 14.

⁸ After the Stuart-Atlanta line tripped, Dayton Power & Light did not immediately provide an update of a change in equipment availability using a standard form that posts the status change in the SDX (System Data Exchange, the NERC database which maintains real-time information on grid equipment status), which relays that notice to reliability coordinators and control areas. After its state estimator failed to solve properly, MISO checked the SDX to make sure that they had properly identified all available equipment and outages, but found no posting there regarding Stuart-Atlanta’s outage.

⁹ Investigation team field visit, interviews with FE personnel on October 8-9, 2003.

¹⁰ DOE Site Visit to First Energy, September 3, 2003, Interview with David M. Elliott.

¹¹ FE Report, “Investigation of FirstEnergy’s Energy Management System Status on August 14, 2003,” Bullet 1, Section 4.2.11.

¹² Investigation team interviews with FE, October 8-9, 2003.

¹³ Investigation team field visit to FE, October 8-9, 2003: team was advised that FE had discovered this effect during post-event investigation and testing of the EMS. FE’s report “Investigation of FirstEnergy’s Energy Management System Status on August 14, 2003” also indicates that this finding was “verified using the strip charts from 8-14-03” (page 23), not that the investigation of this item was instigated by operator reports of such a failure.

¹⁴ There is a conversation between a Phil and a Tom that speaks of “flatlining” 15:01:33. Channel 15. There is no mention of AGC or generation control in the DOE Site Visit interviews with the reliability coordinator.

¹⁵ FE Report, “Investigation of FirstEnergy’s Energy Management System Status on August 14, 2003.”

¹⁶ Investigation team field visit to FE, October 8-9, 2003, Sanicky Interview: “From his experience, it is not unusual for alarms to fail. Often times, they may be slow to update or they may die completely. From his experience as a real-time operator, the fact that the alarms failed did not surprise him.” Also from same document, Mike McDonald interview, “FE has previously had [servers] down at the same time. The big issue for them was that they were not receiving new alarms.”

¹⁷ A “cold” reboot of the XA21 system is one in which all nodes (computers, consoles, etc.) of the system are shut down and then restarted. Alternatively, a given XA21 node can be “warm” rebooted wherein only that node is shut down and restarted, or restarted from a shutdown state. A cold reboot will take significantly longer to perform than a warm one. Also during a cold reboot much more of the system is unavailable for use by the control room operators for visibility or control over the power system. Warm reboots are not uncommon, whereas cold reboots are rare. All reboots undertaken by FE’s IT EMSS support personnel on August 14 were warm reboots.

¹⁸ The cold reboot was done in the early morning of 15 August and corrected the alarm problem as hoped.

¹⁹ Example at 14:19, Channel 14, FE transcripts.

²⁰ Example at 14:25, Channel 8, FE transcripts.

²¹ Example at 14:32, Channel 15, FE transcripts.

²² “Interim Report, Utility Vegetation Management,” U.S.-Canada Joint Outage Investigation Task Force, Vegetation Management Program Review, October 2003, page 7.

²³ Investigation team transcript, meeting on September 9, 2003, comments by Mr. Steve Morgan, Vice President Electric Operations:

Mr. Morgan: The sustained outage history for these lines, 2001, 2002, 2003, up until the event, Chamberlin-Harding had zero operations for those two-and-a-half years. And Hanna-Juniper had six operations in 2001, ranging from four minutes to maximum of 34 minutes. Two were unknown, one was lightning, one was a relay failure, and two were really relay scheme mis-operations. They’re category other. And typically, that—I don’t know what this is particular to operations, that typically occurs when there is a mis-operation. Star-South Canton had no operations in that same period of time, two-and-a-half years. No sustained outages. And Sammis-Star, the line we haven’t talked about, also no sustained outages during that two-and-a-half year period. So is it normal? No. But 345 lines do operate, so it’s not unknown.

²⁴ “Utility Vegetation Management Final Report,” CN Utility Consulting, March 2004, page 32.

²⁵ “FE MISO Findings,” page 11.

²⁶ FE was conducting right-of-way vegetation maintenance on a 5-year cycle, and the tree crew at Hanna-Juniper was three spans away, clearing vegetation near the line, when the contact occurred on August 14. Investigation team 9/9/03 meeting transcript, and investigation field team discussion with the tree-trimming crew foreman.

²⁷ Based on “FE MISO Findings” document, page 11.

²⁸ “Interim Report, Utility Vegetation Management,” US-Canada Joint Outage Task Force, Vegetation Management Program Review, October 2003, page 6.

²⁹ Investigation team September 9, 2003 meeting transcripts, Mr. Steve Morgan, First Energy Vice President, Electric System Operations:

Mr. Benjamin: Steve, just to make sure that I'm understanding it correctly, you had indicated that once after Hanna-Juniper relayed out, there wasn't really a problem with voltage on the system until Star-S. Canton operated. But were the system operators aware that when Hanna-Juniper was out, that if Star-S. Canton did trip, they would be outside of operating limits?

Mr. Morgan: I think the answer to that question would have required a contingency analysis to be done probably on demand for that operation. It doesn't appear to me that a contingency analysis, and certainly not a demand contingency analysis, could have been run in that period of time. Other than experience, I don't know that they would have been able to answer that question. And what I know of the record right now is that it doesn't appear that they ran contingency analysis on demand.

Mr. Benjamin: Could they have done that?

Mr. Morgan: Yeah, presumably they could have.

Mr. Benjamin: You have all the tools to do that?

Mr. Morgan: They have all the tools and all the information is there. And if the State Estimator is successful in solving, and all the data is updated, yeah, they could have. I would say in addition to those tools, they also have access to the planning load flow model that can actually run the same—full load of the model if they want to.

³⁰ Example synchronized at 14:32 (from 13:32) #18 041 TDC-E2 283.wav, AEP transcripts.

³¹ Example synchronized at 14:19 #2 020 TDC-E1 266.wav, AEP transcripts.

³² Example at 15:36 Channel 8, FE transcripts.

³³ Example at 15:41:30 Channel 3, FE transcripts.

³⁴ Example synchronized at 15:36 (from 14:43) Channel 20, MISO transcripts.

³⁵ Example at 15:42:49, Channel 8, FE transcripts.

³⁶ Example at 15:46:00, Channel 8 FE transcripts.

³⁷ Example at 15:45:18, Channel 4, FE transcripts.

³⁸ Example at 15:46:00, Channel 8 FE transcripts.

³⁹ Example at 15:50:15, Channel 12 FE transcripts.

⁴⁰ Example synchronized at 15:48 (from 14:55), channel 22, MISO transcripts.

⁴¹ Example at 15:56:00, Channel 31, FE transcripts.

⁴² FE Transcripts 15:45:18 on Channel 4 and 15:56:49 on Channel 31.

⁴³ The operator logs from FE's Ohio control center indicate that the west desk operator knew of the alarm system failure at 14:14, but that the east desk operator first knew of this development at 15:45. These entries may have been entered after the times noted, however.

⁴⁴ The investigation team determined that FE was using a different set of line ratings for Sammis-Star than those being used in the MISO and PJM reliability coordinator calculations or by its neighbor AEP. Specifically, FE was operating Sammis-Star assuming that the 345-kV line was rated for summer normal use at 1,310 MVA, with a summer emergency limit rating of 1,310 MVA. In contrast, MISO, PJM and AEP were using a more conservative rating of 950 MVA normal and 1,076 MVA emergency for this line. The facility owner (in this case FE) is the entity which provides the line rating; when and why the ratings were changed and not communicated to all concerned parties has not been determined.

6. The Cascade Stage of the Blackout

Chapter 5 described how uncorrected problems in northern Ohio developed to 16:05:57 EDT, the last point at which a cascade of line trips could have been averted. However, the Task Force’s investigation also sought to understand how and why the cascade spread and stopped as it did. As detailed below, the investigation determined the sequence of events in the cascade, and how and why it spread, and how it stopped in each general geographic area.

Based on the investigation to date, the investigation team concludes that the cascade spread beyond Ohio and caused such a widespread blackout for three principal reasons. First, the loss of the Sammis-Star 345-kV line in Ohio, following the loss of other transmission lines and weak voltages within Ohio, triggered many subsequent line trips. Second, many of the key lines which tripped between 16:05:57 and 16:10:38 EDT operated on zone 3 impedance relays (or zone 2 relays set to operate like zone 3s) which responded to overloads rather than true faults on the grid. The speed at which they tripped spread the reach and accelerated the spread of the cascade beyond the Cleveland-Akron area. Third, the evidence collected indicates that the relay protection settings for the transmission lines, generators and under-frequency load-shedding in the northeast may not be entirely appropriate and are certainly not coordinated and integrated to reduce the likelihood and consequences of a cascade—nor were they intended to do so. These issues are discussed in depth below.

This analysis is based on close examination of the events in the cascade, supplemented by complex, detailed mathematical modeling of the electrical phenomena that occurred. At the completion of this report, the modeling had progressed through 16:10:40 EDT, and was continuing. Thus this chapter is informed and validated by modeling (explained below) up until that time. Explanations after that time reflect the investigation team’s best hypotheses given the available data, and may be confirmed or modified when the modeling is complete. However, simulation of these events is so

complex that it may be impossible to ever completely prove these or other theories about the fast-moving events of August 14. Final modeling results will be published by NERC as a technical report in several months.

Why Does a Blackout Cascade?

Major blackouts are rare, and no two blackout scenarios are the same. The initiating events will vary, including human actions or inactions, system topology, and load/generation balances. Other factors that will vary include the distance between generating stations and major load centers, voltage profiles across the grid, and the types and settings of protective relays in use.

Some wide-area blackouts start with short circuits (faults) on several transmission lines in short succession—sometimes resulting from natural causes such as lightning or wind or, as on August 14, resulting from inadequate tree management in right-of-way areas. A fault causes a high current and low voltage on the line containing the fault. A protective relay for that line detects the high current and low voltage and quickly trips the circuit breakers to isolate that line from the rest of the power system.

A cascade is a dynamic phenomenon that cannot be stopped by human intervention once started. It occurs when there is a sequential tripping of numerous transmission lines and generators in a widening geographic area. A cascade can be triggered by just a few initiating events, as was seen on August 14. Power swings and voltage fluctuations caused by these initial events can cause other lines to detect high currents and low voltages that appear to be faults, even if faults do not actually exist on those other lines. Generators are tripped off during a cascade to protect them from severe power and voltage swings. Protective relay systems work well to protect lines and generators from damage and to isolate them from the system under normal and abnormal system conditions.

But when power system operating and design criteria are violated because several outages occur

simultaneously, commonly used protective relays that measure low voltage and high current cannot distinguish between the currents and voltages seen in a system cascade from those caused by a fault. This leads to more and more lines and generators being tripped, widening the blackout area.

How Did the Cascade Evolve on August 14?

A series of line outages in northeast Ohio starting at 15:05 EDT caused heavy loadings on parallel circuits, leading to the trip and lock-out of FE's Sammis-Star 345-kV line at 16:05:57 Eastern Daylight Time. This was the event that triggered a cascade of interruptions on the high voltage system, causing electrical fluctuations and facility trips such that within seven minutes the blackout rippled from the Cleveland-Akron area across much of the northeast United States and Canada. By 16:13 EDT, more than 508 generating units at 265 power plants had been lost, and tens of millions of people in the United States and Canada were without electric power.

The events in the cascade started relatively slowly. Figure 6.1 illustrates how the number of lines and generation lost stayed relatively low during the Ohio phase of the blackout, but then picked up speed after 16:08:59 EDT. The cascade was complete only three minutes later.

Chapter 5 described the four phases that led to the initiation of the cascade at about 16:06 EDT. After 16:06 EDT, the cascade evolved in three distinct phases:

- ◆ **Phase 5.** The collapse of FE's transmission system induced unplanned shifts of power across the region. Shortly before the collapse, large (but normal) electricity flows were moving across FE's system from generators in the south (Tennessee and Kentucky) and west (Illinois and Missouri) to load centers in northern Ohio, eastern Michigan, and Ontario. A series of lines within northern Ohio tripped under the high

Figure 6.1. Rate of Line and Generator Trips During the Cascade

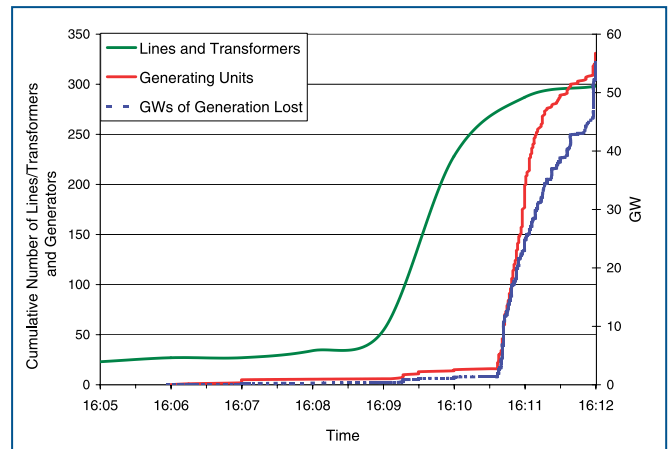

Impedance Relays

The most common protective device for transmission lines is the impedance (Z) relay (also known as a distance relay). It detects changes in currents (I) and voltages (V) to determine the apparent impedance ($Z=V/I$) of the line. A relay is installed at each end of a transmission line. Each relay is actually three relays within one, with each element looking at a particular “zone” or length of the line being protected.

- ◆ The first zone looks for faults over 80% of the line next to the relay, with no time delay before the trip.
- ◆ The second zone is set to look at the entire line and slightly beyond the end of the line with a slight time delay. The slight delay on the zone 2 relay is useful when a fault occurs near one end of the line. The zone 1 relay near that end operates quickly to trip the circuit breakers on that end. However, the zone 1 relay on the other end may not be able to tell if the fault is

just inside the line or just beyond the line. In this case, the zone 2 relay on the far end trips the breakers after a short delay, after the zone 1 relay near the fault opens the line on that end first.

- ◆ The third zone is slower acting and looks for line faults and faults well beyond the length of the line. It can be thought of as a remote relay or breaker backup, but should not trip the breakers under typical emergency conditions.

An impedance relay operates when the apparent impedance, as measured by the current and voltage seen by the relay, falls within any one of the operating zones for the appropriate amount of time for that zone. The relay will trip and cause circuit breakers to operate and isolate the line. All three relay zone operations protect lines from faults and may trip from apparent faults caused by large swings in voltages and currents.

loads, hastened by the impact of Zone 3 impedance relays. This caused a series of shifts in power flows and loadings, but the grid stabilized after each.

- ◆ **Phase 6.** After 16:10:36 EDT, the power surges resulting from the FE system failures caused lines in neighboring areas to see overloads that caused impedance relays to operate. The result was a wave of line trips through western Ohio that separated AEP from FE. Then the line trips progressed northward into Michigan separating western and eastern Michigan, causing a power flow reversal within Michigan toward Cleveland. Many of these line trips were from Zone 3 impedance relay actions that accelerated the speed of the line trips and reduced the potential time in which grid operators might have identified the growing problem and acted constructively to contain it.

With paths cut from the west, a massive power surge flowed from PJM into New York and Ontario in a counter-clockwise flow around Lake Erie to serve the load still connected in eastern Michigan and northern Ohio. Relays on the lines between PJM and New York saw this massive power surge as faults and tripped those lines. Ontario's east-west tie line also became overloaded and tripped, leaving northwest Ontario connected to Manitoba and Minnesota. The entire northeastern United States and eastern Ontario then became a large electrical island separated from the rest of the Eastern Interconnection. This large area, which had been importing power prior to the cascade, quickly became unstable after 16:10:38 as there was not sufficient generation on-line within the island to meet electricity demand. Systems to the south and west of the split, such as PJM, AEP and others further away, remained intact and were mostly unaffected by the outage. Once the northeast split from the rest of the Eastern Interconnection, the cascade was isolated.

- ◆ **Phase 7.** In the final phase, after 16:10:46 EDT, the large electrical island in the northeast had less generation than load, and was unstable with large power surges and swings in frequency and voltage. As a result, many lines and generators across the disturbance area tripped, breaking the area into several electrical islands. Generation and load within these smaller islands was often unbalanced, leading to further tripping of lines and generating units until equilibrium was established in each island.

Although much of the disturbance area was fully blacked out in this process, some islands were able to reach equilibrium without total loss of service. For example, the island consisting of most of New England and the Maritime Provinces stabilized and generation and load returned to balance. Another island consisted of load in western New York and a small portion of Ontario, supported by some New York generation, the large Beck and Saunders plants in Ontario, and the 765-kV interconnection to Québec. This island survived but some other areas with large load centers within the island collapsed into a blackout condition (Figure 6.2).

What Stopped the August 14 Blackout from Cascading Further?

The investigation concluded that a combination of the following factors determined where and when the cascade stopped spreading:

- ◆ The effects of a disturbance travel over power lines and become damped the further they are from the initial point, much like the ripple from a stone thrown in a pond. Thus, the voltage and current swings seen by relays on lines farther away from the initial disturbance are not as severe, and at some point they are no longer sufficient to cause lines to trip.
- ◆ Higher voltage lines and more densely networked lines, such as the 500-kV system in PJM and the 765-kV system in AEP, are better able to absorb voltage and current swings and thus serve as a barrier to the spread of a cascade. As seen in Phase 6, the cascade progressed into western Ohio and then northward through Michigan through the areas that had the fewest transmission lines. Because there were fewer

Figure 6.2. Area Affected by the Blackout

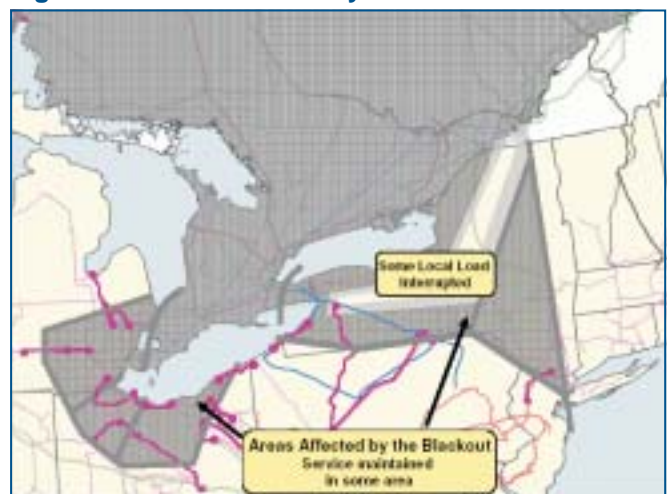

System Oscillations, Stable, Transient, and Dynamic Conditions

The electric power system constantly experiences small power oscillations that do not lead to system instability. They occur as generator rotors accelerate or slow down while rebalancing electrical output power to mechanical input power, to respond to changes in load or network conditions. These oscillations are observable in the power flow on transmission lines that link generation to load or in the tie lines that link different regions of the system together. But with a disturbance to the network, the oscillations can become more severe, even to the point where flows become progressively so great that protective relays trip the connecting lines. If the lines connecting different electrical regions separate, each region will find its own frequency, depending on the load to generation balance at the time of separation.

Oscillations that grow in amplitude are called unstable oscillations. Such oscillations, once initiated, cause power to flow back and forth across the system like water sloshing in a rocking tub.

In a stable electric system, if a disturbance such as a fault occurs, the system will readjust and rebalance within a few seconds after the fault clears. If a fault occurs, protective relays can trip in less than 0.1 second. If the system recovers and rebalances within less than 3 seconds, with the possible loss of only the faulted element and a few generators in the area around the fault, then that condition is termed “transiently stable.” If the system takes from 3 to 30 seconds to recover and stabilize, it is “dynamically stable.” But in

rare cases when a disturbance occurs, the system may appear to rebalance quickly, but it then over-shoots and the oscillations can grow, causing widespread instability that spreads in terms of both the magnitude of the oscillations and in geographic scope. This can occur in a system that is heavily loaded, causing the electrical distance (apparent impedance) between generators to be longer, making it more difficult to keep the machine angles and speeds synchronized. In a system that is well damped, the oscillations will settle out quickly and return to a steady balance. If the oscillation continues over time, neither growing nor subsiding, it is a poorly damped system.

The illustration below, of a weight hung on a spring balance, illustrates a system which oscillates over several cycles to return to balance. A critical point to observe is that in the process of hunting for its balance point, the spring overshoots the true weight and balance point of the spring and weight combined, and must cycle through a series of exaggerated overshoots and underweight rebounds before settling down to rest at its true balance point. The same process occurs on an electric system, as can be observed in this chapter.

If a system is in transient instability, the oscillations following a disturbance will grow in magnitude rather than settle out, and it will be unable to readjust to a stable, steady state. This is what happened to the area that blacked out on August 14, 2003.

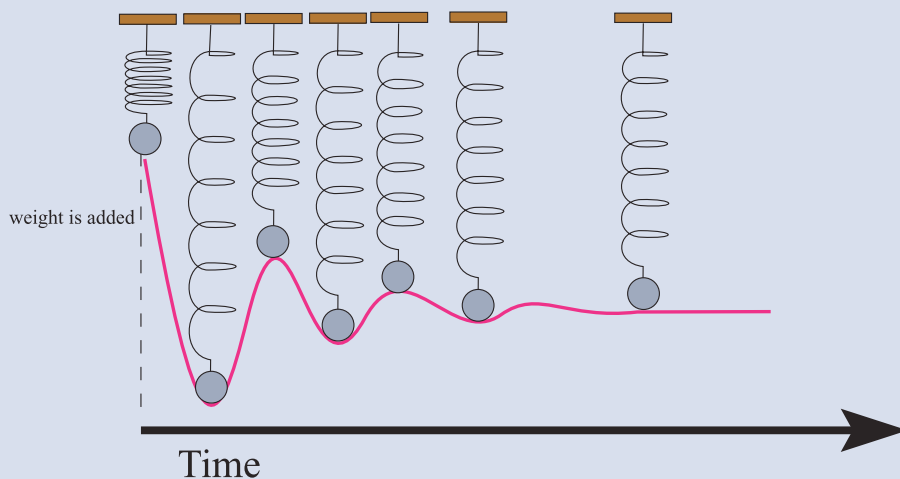

lines, each line absorbed more of the power and voltage surges and was more vulnerable to tripping. A similar effect was seen toward the east as the lines between New York and Pennsylvania, and eventually northern New Jersey tripped. The cascade of transmission line outages became contained after the northeast United States and Ontario were completely separated from the rest of the Eastern Interconnection and no more power flows were possible into the northeast (except the DC ties from Québec, which continued to supply power to western New York and New England).

- ◆ Line trips isolated some areas from the portion of the grid that was experiencing instability. Many of these areas retained sufficient on-line generation or the capacity to import power from other parts of the grid, unaffected by the surges or instability, to meet demand. As the cascade progressed, and more generators and lines tripped off to protect themselves from severe damage, some areas completely separated from the unstable part of the Eastern Interconnection. In many of these areas there was sufficient generation to match load and stabilize the system. After the large island was formed in the northeast, symptoms of frequency and voltage decay emerged. In some parts of the northeast, the system became too unstable and shut itself down. In other parts, there was sufficient generation, coupled with fast-acting automatic load shedding, to stabilize frequency and voltage. In this manner, most of New England and the Maritime Provinces remained energized. Approximately half of the generation and load remained on in western New York, aided by generation in southern Ontario that split and stayed with western New York. There were other smaller isolated pockets of load and generation that were able to achieve equilibrium and remain energized.

Phase 5: 345-kV Transmission System Cascade in Northern Ohio and South-Central Michigan

Overview of This Phase

After the loss of FE's Sammis-Star 345-kV line and the underlying 138-kV system, there were no large capacity transmission lines left from the south to support the significant amount of load in northern Ohio (Figure 6.3). This overloaded the

transmission paths west and northwest into Michigan, causing a sequential loss of lines and power plants.

Key Events in This Phase

- 5A) 16:05:57 EDT: Sammis-Star 345-kV tripped by zone 3 relay.
- 5B) 16:08:59 EDT: Galion-Ohio Central-Muskingum 345-kV line tripped on zone 3 relay.
- 5C) 16:09:06 EDT: East Lima-Fostoria Central 345-kV line tripped on zone 3 relay, causing major power swings through New York and Ontario into Michigan.
- 5D) 16:09:08 EDT to 16:10:27 EDT: Several power plants lost, totaling 937 MW.

5A) Sammis-Star 345-kV Tripped: 16:05:57 EDT

Sammis-Star did not trip due to a short circuit to ground (as did the prior 345-kV lines that tripped). Sammis-Star tripped due to protective zone 3 relay action that measured low apparent impedance (depressed voltage divided by abnormally high line current) (Figure 6.4). There was no fault and no major power swing at the time of the trip—rather, high flows above the line's emergency rating together with depressed voltages caused the overload to appear to the protective relays as a remote fault on the system. In effect, the relay could no longer differentiate between a remote three-phase fault and an exceptionally high line-load condition. Moreover, the reactive flows (VAr) on the line were almost ten times higher than they had been earlier in the day because of the current overload. The relay operated as it was designed to do.

Figure 6.3. Sammis-Star 345-kV Line Trip, 16:05:57 EDT

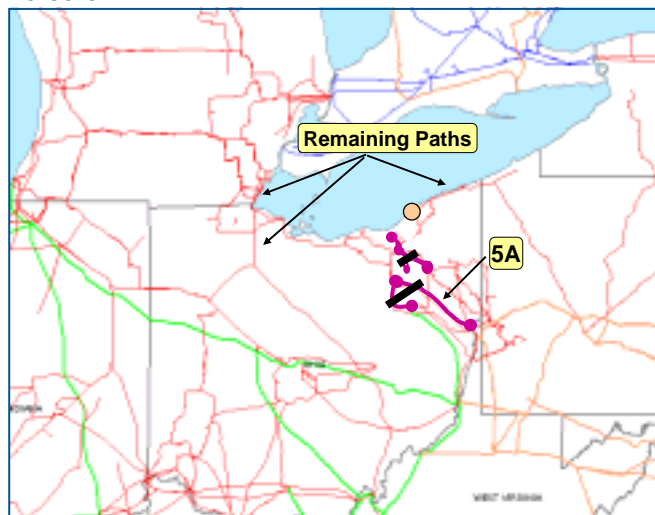

The Sammis-Star 345-kV line trip completely severed the 345-kV path into northern Ohio from southeast Ohio, triggering a new, fast-paced sequence of 345-kV transmission line trips in which each line trip placed a greater flow burden on those lines remaining in service. These line outages left only three paths for power to flow into western Ohio: (1) from northwest Pennsylvania to northern Ohio around the south shore of Lake Erie, (2) from southwest Ohio toward northeast Ohio, and (3) from eastern Michigan and Ontario. The line interruptions substantially weakened northeast Ohio as a source of power to eastern Michigan, making the Detroit area more reliant on 345-kV lines west and northwest of Detroit, and from northwestern Ohio to eastern Michigan. The impact of this trip was felt across the grid—it caused a 100 MW increase in flow from PJM into New York and through to Ontario.¹ Frequency in the Eastern Interconnection increased momentarily by 0.02 Hz.

Soon after the Sammis-Star trip, four of the five 48 MW Handsome Lake combustion turbines in western Pennsylvania tripped off-line. These units are connected to the 345-kV system by the Homer City-Wayne 345-kV line, and were operating that day as synchronous condensers to participate in PJM’s spinning reserve market (not to provide voltage support). When Sammis-Star tripped and increased loadings on the local transmission system, the Handsome Lake units were close enough electrically to sense the impact and tripped off-line at 16:07:00 EDT on under-voltage.

During the period between the Sammis-Star trip and the trip of East Lima-Fostoria at 16:09:06.3 EDT, the system was still in a steady-state condition. Although one line after another was

Figure 6.4. Sammis-Star 345-kV Line Trip

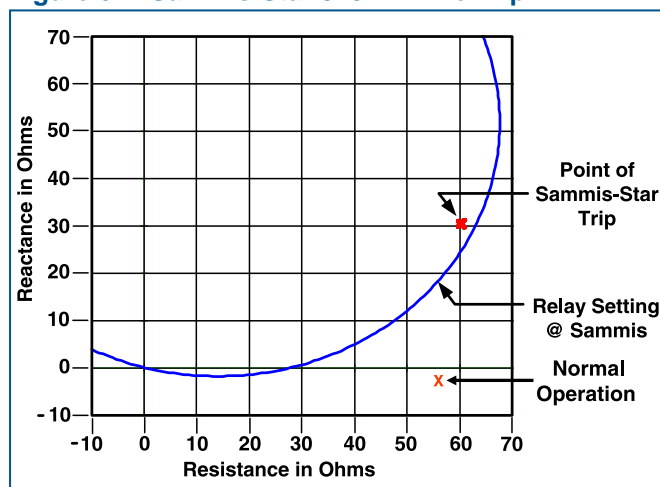

overloading and tripping within Ohio, this was happening slowly enough under relatively stable conditions that the system could readjust—after each line loss, power flows would redistribute across the remaining lines. This is illustrated in Figure 6.5, which shows the MW flows on the Michigan Electrical Coordinated Systems (MECS) interfaces with AEP (Ohio), FirstEnergy (Ohio) and Ontario. The graph shows a shift from 150 MW imports to 200 MW exports from the MECS system into FirstEnergy at 16:05:57 EDT after the loss of Sammis-Star, after which this held steady until 16:08:59, when the loss of East Lima-Fostoria Central cut the main energy path from the south and west into Cleveland and Toledo. Loss of this path was significant, causing flow from MECS into FE to jump from 200 MW up to 2,300 MW, where it bounced somewhat before stabilizing, roughly, until the path across Michigan was cut at 16:10:38 EDT.

Transmission Lines into Northwestern Ohio Tripped, and Generation Tripped in South Central Michigan and Northern Ohio: 16:08:59 EDT to 16:10:27 EDT

- 5B) 16:08:59 EDT: Galion-Ohio Central-Muskingum 345-kV line tripped
- 5C) 16:09:06 EDT: East Lima-Fostoria Central 345-kV line tripped, causing a large power swing from Pennsylvania and New York through Ontario to Michigan

The tripping of the Galion-Ohio Central-Muskingum and East Lima-Fostoria Central

Figure 6.5. Line Flows Into Michigan

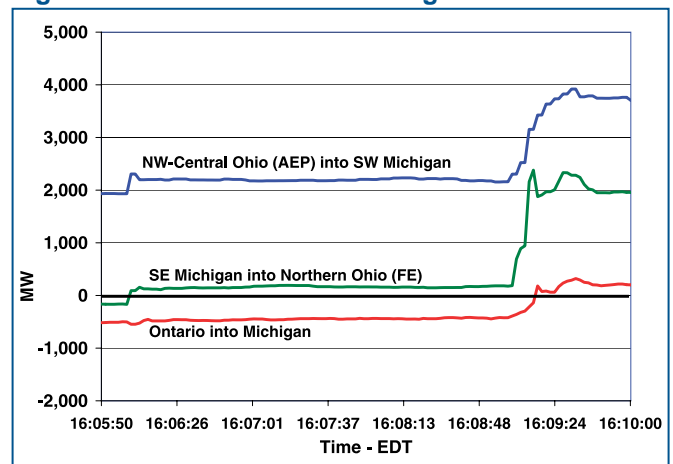

Note: These curves use data collected from the MECS Energy Management System, which records flow quantities every 2 seconds. As a result, the fast power swings that occurred between 16:10:36 to 16:13 were not captured by the recorders and are not reflected in these curves.

345-kV transmission lines removed the transmission paths from southern and western Ohio into northern Ohio and eastern Michigan. Northern Ohio was connected to eastern Michigan by only three 345-kV transmission lines near the southwestern bend of Lake Erie. Thus, the combined northern Ohio and eastern Michigan load centers were left connected to the rest of the grid only by: (1) transmission lines eastward from northeast Ohio to northwest Pennsylvania along the southern shore of Lake Erie, and (2) westward by lines west and northwest of Detroit, Michigan and from Michigan into Ontario (Figure 6.6).

The Galion-Ohio Central-Muskingum 345-kV line tripped first at Muskingum at 16:08:58.5 EDT on a phase-to-ground fault, reclosed and tripped again at 16:08:58.6 at Ohio Central, reclosed and tripped again at Muskingum on a Zone 3 relay, and finally tripped at Galion on a ground fault.

After the Galion-Ohio Central-Muskingum line outage and numerous 138-kV line trips in central Ohio, the East Lima-Fostoria Central 345-kV line tripped at 16:09:06 EDT on Zone 3 relay operation due to high current and extremely low voltage (80%). Investigation team modeling indicates that if automatic under-voltage load-shedding had been in place in northeast Ohio, it might have been triggered at or before this point, and dropped enough load to reduce or eliminate the subsequent line overloads that spread the cascade.

Recommendations
8, page 147; 21, page 158

Figure 6.7, a high-speed recording of 345-kV flows past Niagara Falls from the Hydro One recorders,

Figure 6.6. Ohio 345-kV Lines Trip, 16:08:59 to 16:09:07 EDT

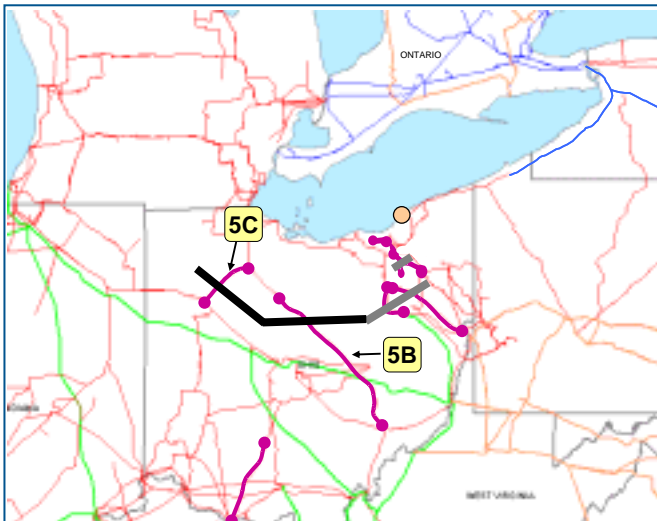

shows the impact of the East Lima-Fostoria Central and the New York to Ontario power swing, which continued to oscillate for over 10 seconds. Looking at the MW flow line, it is clear that when Sammis-Star tripped, the system experienced oscillations that quickly damped out and rebalanced. But East Lima-Fostoria triggered significantly greater oscillations that worsened in magnitude for several cycles, and returned to stability but continued to flutter until the Argenta-Battle Creek trip 90 seconds later. Voltages also began declining at this time.

After the East Lima-Fostoria Central trip, power flows increased dramatically and quickly on the lines into and across southern Michigan. Although power had initially been flowing northeast out of Michigan into Ontario, that flow suddenly reversed and approximately 500 to 700 MW of power (measured at the Michigan-Ontario border, and 437 MW at the Ontario-New York border at Niagara) flowed southwest out of Ontario through Michigan to serve the load of Cleveland and Toledo. This flow was fed by 700 MW pulled out of PJM through New York on its 345-kV network.² This was the first of several inter-area power and frequency events that occurred over the next two minutes. This was the system's response to the loss of the northwest Ohio transmission paths (above), and the stress that the still-high Cleveland, Toledo, and Detroit loads put onto the surviving lines and local generators.

Figure 6.7 also shows the magnitude of subsequent flows and voltages at the New York-Ontario Niagara border, triggered by the trips of the Argenta-Battle Creek, Argenta-Tompkins, Hampton-Pontiac and Thetford-Jewell 345-kV lines in Michigan, and the Erie West-Ashtabula-Perry

Figure 6.7. New York-Ontario Line Flows at Niagara

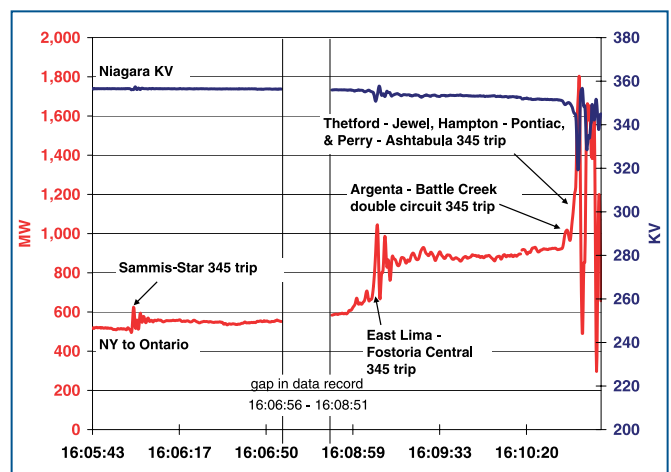

345-kV line linking the Cleveland area to Pennsylvania. Farther south, the very low voltages on the northern Ohio transmission system made it very difficult for the generation in the Cleveland and Lake Erie area to maintain synchronism with the Eastern Interconnection. Over the next two minutes, generators in this area shut down after reaching a point of no recovery as the stress level across the remaining ties became excessive.

Figure 6.8, of metered power flows along the New York interfaces, documents how the flows heading north and west toward Detroit and Cleveland varied at different points on the grid. Beginning at 16:09:05 EDT, power flows jumped simultaneously across all three interfaces—but when the first power surge peaked at 16:09:09, the change in flow was highest on the PJM interface and lowest on the New England interface. Power flows increased significantly on the PJM-NY and NY-Ontario interfaces because of the redistribution of flow around Lake Erie. The New England and Maritime systems maintained the same generation to load balance and did not carry the redistributed flows because they were not in the direct path of the flows, so that interface with New York showed little response.

Before this first major power swing on the Michigan/Ontario interface, power flows in the NPCC Region (Québec, Ontario and the Maritimes, New England and New York) were typical for the summer period, and well within acceptable limits. Transmission and generation facilities were then in a secure state across the NPCC region.

Zone 3 Relays and the Start of the Cascade

Zone 3 relays are set to provide breaker failure and relay backup for remote distance faults on a transmission line. If it senses a fault past the immediate

reach of the line and its zone 1 and zone 2 settings, a zone 3 relay waits through a 1 to 2 second time delay to allow the primary line protection to act first. A few lines have zone 3 settings designed with overload margins close to the long-term emergency limit of the line, because the length and configuration of the line dictate a higher apparent impedance setting. Thus it is possible for a zone 3 relay to operate on line load or overload in extreme contingency conditions even in the absence of a fault (which is why many regions in the United States and Canada have eliminated the use of zone 3 relays on 230-kV and greater lines). Some transmission operators set zone 2 relays to serve the same purpose as zone 3s—i.e., to reach well beyond the length of the line it is protecting and protect against a distant fault on the outer lines.

The Sammis-Star line tripped at 16:05:57 EDT on a zone 3 impedance relay although there were no faults occurring at the time, because increased real and reactive power flow caused the apparent impedance to be within the impedance circle (reach) of the relay. Between 16:06:01 and 16:10:38.6 EDT, thirteen more important 345 and 138-kV lines tripped on zone 3 operations that afternoon at the start of the cascade, including Galion-Ohio Central-Muskingum, East Lima-Fostoria Central, Argenta-Battle Creek, Argenta-Tompkins, Battle Creek-Oneida, and Perry-Ashtabula (Figure 6.9). These included several zone 2 relays in Michigan that had been set to operate like zone 3s, overreaching the line by more than 200% with no intentional time delay for remote breaker failure protection.³ All of these relays operated according to their settings. However, the zone 3 relays (and zone 2 relays acting like zone 3s) acted so quickly that they impeded the natural ability of the electric system to hold together, and did not allow for any operator intervention to attempt to stop the spread of the cascade. The investigation team concluded that because these zone 2 and 3 relays tripped after each line overloaded, these relays were the common mode of failure that accelerated the geographic spread of the cascade. Given grid conditions and loads and the limited operator tools available, the speed of the zone 2 and 3 operations across Ohio and Michigan eliminated any possibility after 16:05:57 EDT that either operator action or automatic intervention could have limited or mitigated the growing cascade.

What might have happened on August 14 if these lines had not tripped on zone 2 and 3 relays? Each

Figure 6.8. First Power Swing Has Varying Impacts Across the Grid

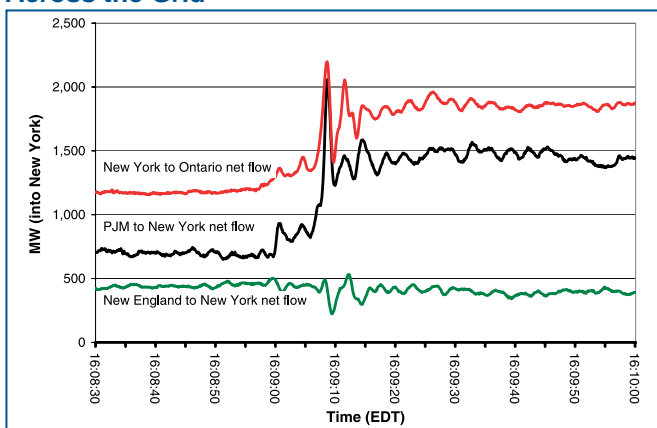
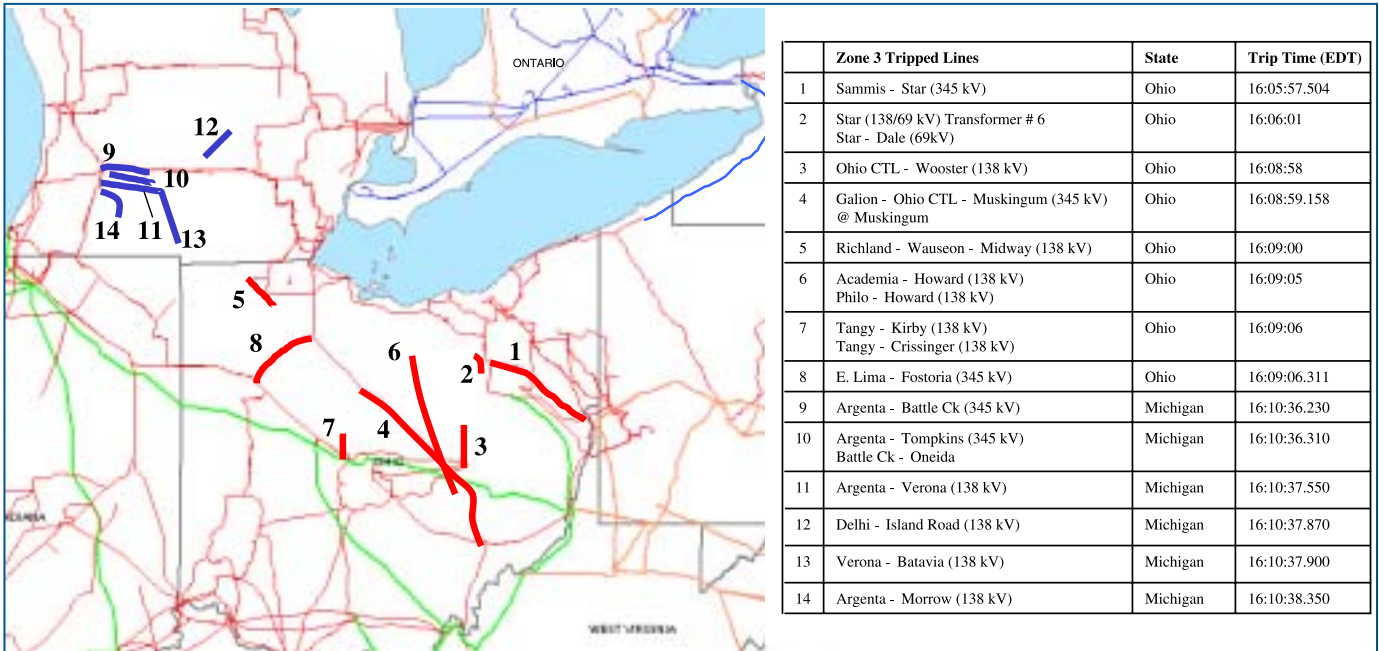

Figure 6.9. Map of Zone 3 (and Zone 2s Operating Like Zone 3s) Relay Operations on August 14, 2003



Voltage Collapse

Although the blackout of August 14 has been labeled by some as a voltage collapse, it was not a voltage collapse as that term has been traditionally used by power system engineers. Voltage collapse occurs when an increase in load or loss of generation or transmission facilities causes dropping voltage, which causes a further reduction in reactive power from capacitors and line charging, and still further voltage reductions. If the declines continue, these voltage reductions cause additional elements to trip, leading to further reduction in voltage and loss of load. The result is a progressive and uncontrollable decline in voltage, all because the power system is unable to provide the reactive power required to supply the reactive power demand. This did not occur on August 14. While the Cleveland-Akron area was short of reactive power reserves they were just sufficient to supply the reactive power demand in the area and maintain stable albeit depressed voltages for the outage conditions experienced.

But the lines in the Cleveland-Akron area tripped as a result of tree contacts well below the nominal rating of the lines and **not due to low voltages**, which is a precursor for voltage collapse. The initial trips within FirstEnergy began because of ground faults with untrimmed trees, not because of a shortage of reactive power and low voltages. Voltage levels were within

workable bounds before individual transmission trips began, and those trips occurred within normal line ratings rather than in overloads. With fewer lines operational, current flowing over the remaining lines increased and voltage decreased (current increases in inverse proportion to the decrease in voltage for a given amount of power flow)—but it stabilized after each line trip until the next circuit trip. Soon northern Ohio lines began to trip out automatically on protection from overloads, not from insufficient reactive power. Once several lines tripped in the Cleveland-Akron area, the power flow was rerouted to other heavily loaded lines in northern Ohio, causing depressed voltages which led to automatic tripping on protection from overloads. Voltage collapse therefore was not a cause of the cascade.

As the cascade progressed beyond Ohio, it spread due not to insufficient reactive power and a voltage collapse, but because of dynamic power swings and the resulting system instability. Figure 6.7 shows voltage levels recorded at the Niagara area. It shows clearly that voltage levels remained stable until 16:10:30 EDT, despite significant power fluctuations. In the cascade that followed, the voltage instability was a companion to, not a driver of, the angle instability that tripped generators and lines.

was operating with high load, and loads on each line grew as each preceding line tripped out of service. But if these lines had not tripped quickly on zone 2s and 3s, each might have remained heavily loaded, with conductor temperatures increasing, for as long as 20 to 30 minutes before the line sagged into something and experienced a ground fault. For instance, the Dale-West Canton line took 20 minutes to trip under 160 to 180% of its normal rated load. Even with sophisticated modeling it is impossible to predict just how long this delay might have occurred (affected by wind speeds, line loadings, and line length, tension and ground clearance along every span), because the system did not become dynamically unstable until at least after the Thetford-Jewell trip at 16:10:38 EDT. During this period the system would likely have remained stable and been able to readjust after each line trip on ground fault. If this period of deterioration and overloading under stable conditions had lasted for as little as 15 minutes or as long as an hour, it is possible that the growing problems could have been recognized and action taken, such as automatic under-voltage load-shedding, manual load-shedding in Ohio or other measures. So although the operation of zone 2 and 3 relays in Ohio and Michigan did not cause the blackout, it is certain that they greatly expanded and accelerated the spread of the cascade.

Recommendation
21, page 158

5D) Multiple Power Plants Tripped, Totaling 946 MW: 16:09:08 to 16:10:27 EDT

- 16:09:08 EDT: Michigan Cogeneration Venture plant reduction of 300 MW (from 1,263 MW to 963 MW)
- 16:09:17 EDT: Avon Lake 7 unit trips (82 MW)
- 16:09:17 EDT: Burger 3, 4, and 5 units trip (355 MW total)
- 16:09:30 EDT: Kinder Morgan units 3, 6 and 7 trip (209 MW total)

The Burger units tripped after the 138-kV lines into the Burger 138-kV substation (Ohio) tripped from the low voltages in the Cleveland area (Figure 6.10). The MCV plant is in central Michigan. Kinder Morgan is in south-central Michigan. The Kinder-Morgan units tripped due to a transformer fault and one due to over-excitation.

Power flows into Michigan from Indiana increased to serve loads in eastern Michigan and northern Ohio (still connected to the grid through northwest Ohio and Michigan) and voltages dropped from the imbalance between high loads

and limited transmission and generation capability.

Phase 6: The Full Cascade

Between 16:10:36 EDT and 16:13 EDT, thousands of events occurred on the grid, driven by physics and automatic equipment operations. When it was over, much of the northeastern United States and the province of Ontario were in the dark.

Key Phase 6 Events

Transmission Lines Disconnected Across Michigan and Northern Ohio, Generation Shut Down in Central Michigan and Northern Ohio, and Northern Ohio Separated from Pennsylvania: 16:10:36 to 16:10:39 EDT

- 6A) Transmission and more generation tripped within Michigan: 16:10:36 to 16:10:37 EDT:
 - 16:10:36.2 EDT: Argenta-Battle Creek 345-kV line tripped
 - 16:10:36.3 EDT: Argenta-Tompkins 345-kV line tripped
 - 16:10:36.8 EDT: Battle Creek-Oneida 345-kV line tripped
 - 16:10:37 EDT: Sumpter Units 1, 2, 3, and 4 units tripped on under-voltage (300 MW near Detroit)
 - 16:10:37.5 EDT: MCV Plant output dropped from 963 MW to 109 MW on over-current protection.

Together, the above line outages interrupted the west-to-east transmission paths into the Detroit area from south-central Michigan. The Sumpter generation units tripped in response to

Figure 6.10. Michigan and Ohio Power Plants Trip

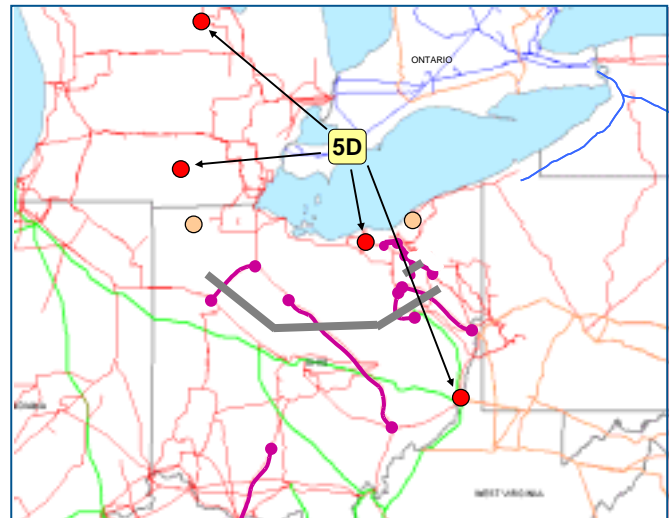

under-voltage on the system. Michigan lines west of Detroit then began to trip, as shown in Figure 6.11.

The Argenta-Battle Creek relay first opened the line at 16:10:36.230 EDT, reclosed it at 16:10:37, then tripped again. This line connects major generators—including the Cook and Palisades nuclear plants and the Campbell fossil plant—to the MECS system. This line is designed with auto-reclose breakers at each end of the line, which do an automatic high-speed reclose as soon as they open to restore the line to service with no interruptions. Since the majority of faults on the North American grid are temporary, automatic reclosing can enhance stability and system reliability. However, situations can occur when the power systems behind the two ends of the line could go out of phase during the high-speed reclose period (typically less than 30 cycles, or one half second, to allow the air to de-ionize after the trip to prevent arc re-ignition). To address this and protect generators from the harm that an out-of-synchronism reconnect could cause, it is worth studying whether a synchro-check relay is needed, to reclose the second breaker only when the two ends are within a certain voltage and phase angle tolerance. No such protection was installed at Argenta-Battle Creek; when the line reclosed, there was a 70° difference in phase across the circuit breaker reclosing the line. There

is no evidence that the reclose caused harm to the local generators.

6B) Western and Eastern Michigan separation started: 16:10:37 EDT to 16:10:38 EDT

16:10:38.2 EDT: Hampton-Pontiac 345-kV line tripped

16:10:38.4 EDT: Thetford-Jewell 345-kV line tripped

After the Argenta lines tripped, the phase angle between eastern and western Michigan began to increase. The Hampton-Pontiac and Thetford-Jewell 345-kV lines were the only lines remaining connecting Detroit to power sources and the rest of the grid to the north and west. When these lines tripped out of service, it left the loads in Detroit, Toledo, Cleveland, and their surrounding areas served only by local generation and the lines north of Lake Erie connecting Detroit east to Ontario and the lines south of Lake Erie from Cleveland east to northwest Pennsylvania. These trips completed the extra-high voltage network separation between eastern and western Michigan.

The Power System Disturbance Recorders at Keith and Lambton, Ontario, captured these events in the flows across the Ontario-Michigan interface, as shown in Figure 6.12 and Figure 6.16. It shows clearly that the west to east Michigan separation (the Thetford-Jewell trip) was the start and Erie West-Ashtabula-Perry was the trigger for the 3,700 MW surge from Ontario into Michigan. When Thetford-Jewell tripped, power that had been flowing into Michigan and Ohio from western Michigan, western Ohio and Indiana was cut off. The nearby Ontario recorders saw a pronounced impact as flows into Detroit readjusted to draw power from the northeast instead. To the south,

Figure 6.11. Transmission and Generation Trips in Michigan, 16:10:36 to 16:10:37 EDT

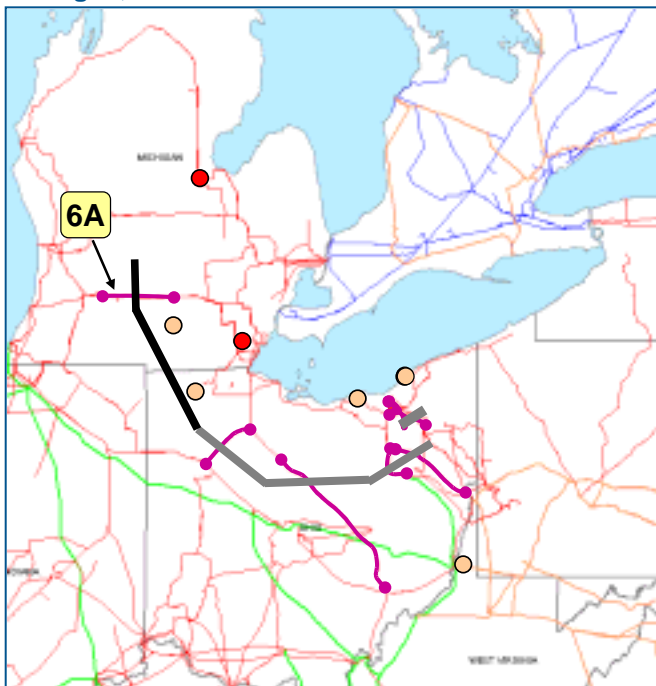
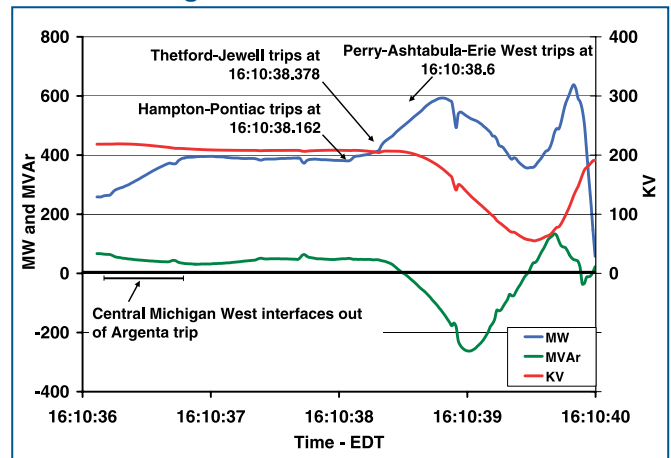

Figure 6.12. Flows on Keith-Waterman 230-kV Ontario-Michigan Tie Line



Erie West-Ashtabula-Perry was the last 345-kV eastern link for northern Ohio loads. When that line severed, all the power that moments before had flowed across Michigan and Ohio paths was now diverted in a counter-clockwise direction around Lake Erie through the single path left in eastern Michigan, pulling power out of Ontario, New York and PJM.

Figures 6.13 and 6.14 show the results of investigation team modeling of the line loadings on the Ohio, Michigan, and other regional interfaces for the period between 16:05:57 until the Thetford-Jewell trip, to understand how power flows shifted during this period. The team simulated evolving system conditions on August 14, 2003, based on the 16:05:50 power flow case developed by the MAAC-ECAR-NPCC Operations Studies Working Group. Each horizontal line in the graph indicates a single or set of 345-kV lines and its loading as a function of normal ratings over time as first one, then another, set of circuits tripped out of service. In general, each subsequent line trip causes the remaining line loadings to rise; where a line drops (as Erie West-Ashtabula-Perry in Figure 6.13 after the Hanna-Juniper trip), that indicates that line loading lightened, most likely due to customers dropped from service. Note that Muskingum and East Lima-Fostoria Central were overloaded before they tripped, but the Michigan west and north interfaces were not overloaded before they tripped. Erie West-Ashtabula-Perry was loaded to 130% after the Hampton-Pontiac and Thetford-Jewell trips.

The Regional Interface Loadings graph (Figure 6.14) shows that loadings at the interfaces between PJM-NY, NY-Ontario and NY-New England were well within normal ratings before the east-west Michigan separation.

Figure 6.13. Simulated 345-kV Line Loadings from 16:05:57 through 16:10:38.4 EDT

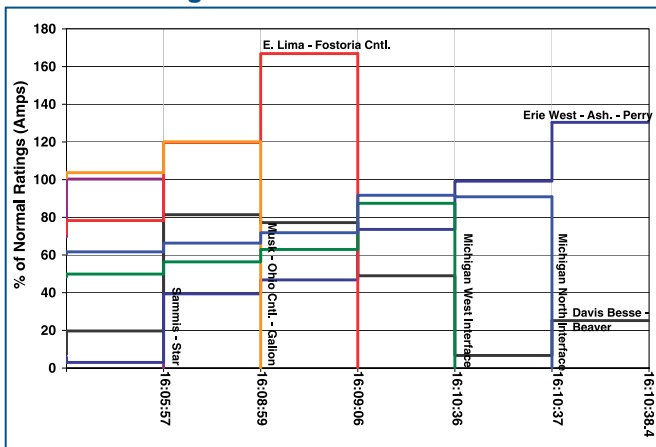

6C) Cleveland separated from Pennsylvania, flows reversed and a huge power surge flowed counter-clockwise around Lake Erie: 16:10:38.6 EDT

16:10:38.6 EDT: Erie West-Ashtabula-Perry 345-kV line tripped at Perry

16:10:38.6 EDT: Large power surge to serve loads in eastern Michigan and northern Ohio swept across Pennsylvania, New Jersey, and New York through Ontario into Michigan.

Perry-Ashtabula was the last 345-kV line connecting northern Ohio to the east south of Lake Erie. This line's trip at the Perry substation on a zone 3 relay operation separated the northern Ohio 345-kV transmission system from Pennsylvania and all eastern 345-kV connections. After this trip, the load centers in eastern Michigan and northern Ohio (Detroit, Cleveland, and Akron) remained connected to the rest of the Eastern Interconnection only to the north at the interface between the Michigan and Ontario systems (Figure 6.15). Eastern Michigan and northern Ohio now had little internal generation left and voltage was declining. The frequency in the Cleveland area dropped rapidly, and between 16:10:39 and 16:10:50 EDT under-frequency load shedding in the Cleveland area interrupted about 1,750 MW of load. However, the load shedding did not drop enough load relative to local generation to rebalance and arrest the frequency decline. Since the electrical system always seeks to balance load and generation, the high loads in Detroit and Cleveland drew power over the only major transmission path remaining—the lines from eastern Michigan into Ontario. Mismatches between generation and load are reflected in changes in frequency, so with more generation than load frequency rises and with less generation than load, frequency falls.

Figure 6.14. Simulated Regional Interface Loadings from 16:05:57 through 16:10:38.4 EDT

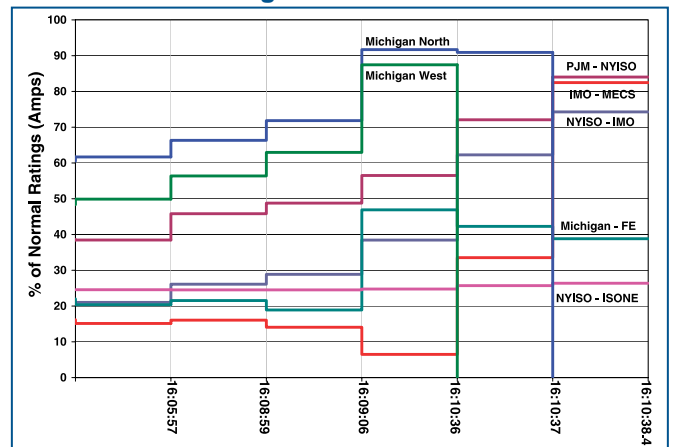

At 16:10:38.6 EDT, after the above transmission paths into Michigan and Ohio failed, the power that had been flowing at modest levels into Michigan from Ontario suddenly jumped in magnitude. While flows from Ontario into Michigan had been in the 250 to 350 MW range since 16:10:09.06 EDT, with this new surge they peaked at 3,700 MW at 16:10:39 EDT (Figure 6.16). Electricity moved along a giant loop through Pennsylvania and into New York and Ontario and then into Michigan via the remaining transmission path to serve the combined loads of Cleveland, Toledo, and Detroit. This sudden large change in power flows drastically lowered voltage and increased current levels on the transmission lines along the Pennsylvania-New York transmission interface.

This was a power surge of large magnitude, so frequency was not the same across the Eastern Interconnection. As Figure 6.16 shows, the power swing resulted in a rapid rate of voltage decay. Flows into Detroit exceeded 3,700 MW and 1,500 MVAR—the power surge was draining real power out of the northeast, causing voltages in Ontario and New York to drop. At the same time, local voltages in the Detroit area were plummeting because Detroit had already lost 500 MW of local generation. Detroit would soon lose synchronism

and black out (as evidenced by the rapid power oscillations decaying after 16:10:43 EDT).

Figure 6.15. Michigan Lines Trip and Ohio Separates from Pennsylvania, 16:10:36 to 16:10:38.6 EDT

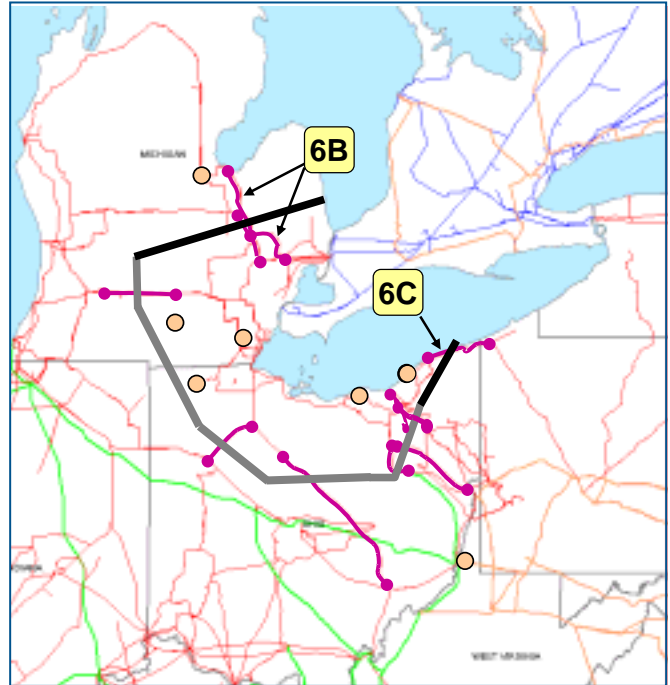

Modeling the Cascade

Computer modeling of the cascade built upon the modeling conducted of the pre-cascade system conditions described in Chapter 5. That earlier modeling developed steady-state load flow and voltage analyses for the entire Eastern Interconnection from 15:00 to 16:05:50 EDT. The dynamic modeling used the steady state load flow model for 16:05:50 as the starting point to simulate the cascade. Dynamic modeling conducts a series of load flow analyses, moving from one set of system conditions to another in steps one-quarter of a cycle long—in other words, to move one second from 16:10:00 to 16:10:01 requires simulation of 240 separate time slices.

The model used a set of equations that incorporate the physics of an electrical system. It contained detailed sub-models to reflect the characteristics of loads, under-frequency load-shedding, protective relay operations, generator operations (including excitation systems and governors), static VAR compensators and other FACTS devices, and transformer tap changers.

The modelers compared model results at each moment to actual system data for that moment to

verify a close correspondence for line flows and voltages. If there was too much of a gap between modeled and actual results, they looked at the timing of key events to see whether actual data might have been mis-recorded, or whether the modeled variance for an event not previously recognized as significant might influence the outcome. Through 16:10:40 EDT, the team achieved very close benchmarking of the model against actual results.

The modeling team consisted of industry members from across the Midwest, Mid-Atlantic and NPCC areas. All have extensive electrical engineering and/or mathematical training and experience as system planners for short- or long-term operations.

This modeling allows the team to verify its hypotheses as to why particular events occurred and the relationships between different events over time. It allows testing of many “what if” scenarios and alternatives, to determine whether a change in system conditions might have produced a different outcome.

Just before the Argenta-Battle Creek trip, when Michigan separated west to east at 16:10:37 EDT, almost all of the generators in the eastern interconnection were moving in synchronism with the overall grid frequency of 60 Hertz (shown at the bottom of Figure 6.17), but when the swing started, those machines absorbed some of its energy as they attempted to adjust and resynchronize with the rapidly changing frequency. In many

cases, this adjustment was unsuccessful and the generators tripped out from milliseconds to several seconds thereafter.

The Perry-Ashtabula-Erie West 345-kV line trip at 16:10:38.6 EDT was the point when the Northeast entered a period of transient instability and a loss of generator synchronism. Between 16:10:38 and 16:10:41 EDT, the power swings caused a sudden extraordinary increase in system frequency, hitting 60.7 Hz at Lambton and 60.4 Hz at Niagara.

Figure 6.16. Active and Reactive Power and Voltage from Ontario into Detroit

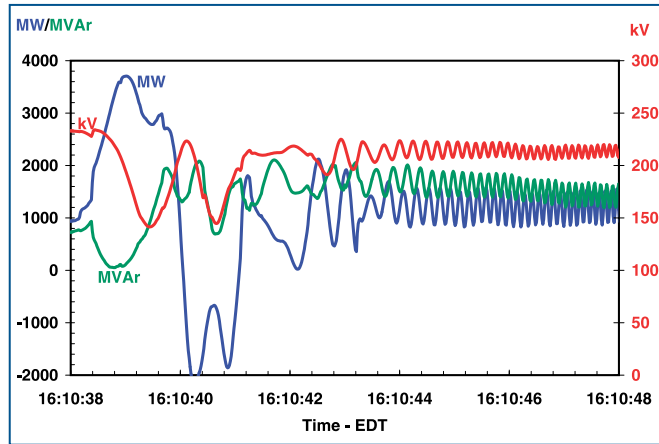

Because the demand for power in Michigan, Ohio, and Ontario was drawing on lines through New York and Pennsylvania, heavy power flows were moving northward from New Jersey over the New York tie lines to meet those power demands, exacerbating the power swing. Figure 6.17 shows actual net line flows summed across the interfaces between the main regions affected by these swings—Ontario into Michigan, New York into Ontario, New York into New England, and PJM into New York. This shows clearly that the power swings did not move in unison across every interface at every moment, but varied in magnitude and direction. This occurred for two reasons. First, the availability of lines to complete the path across

Figure 6.17. Measured Power Flows and Frequency Across Regional Interfaces, 16:10:30 to 16:11:00 EDT, with Key Events in the Cascade

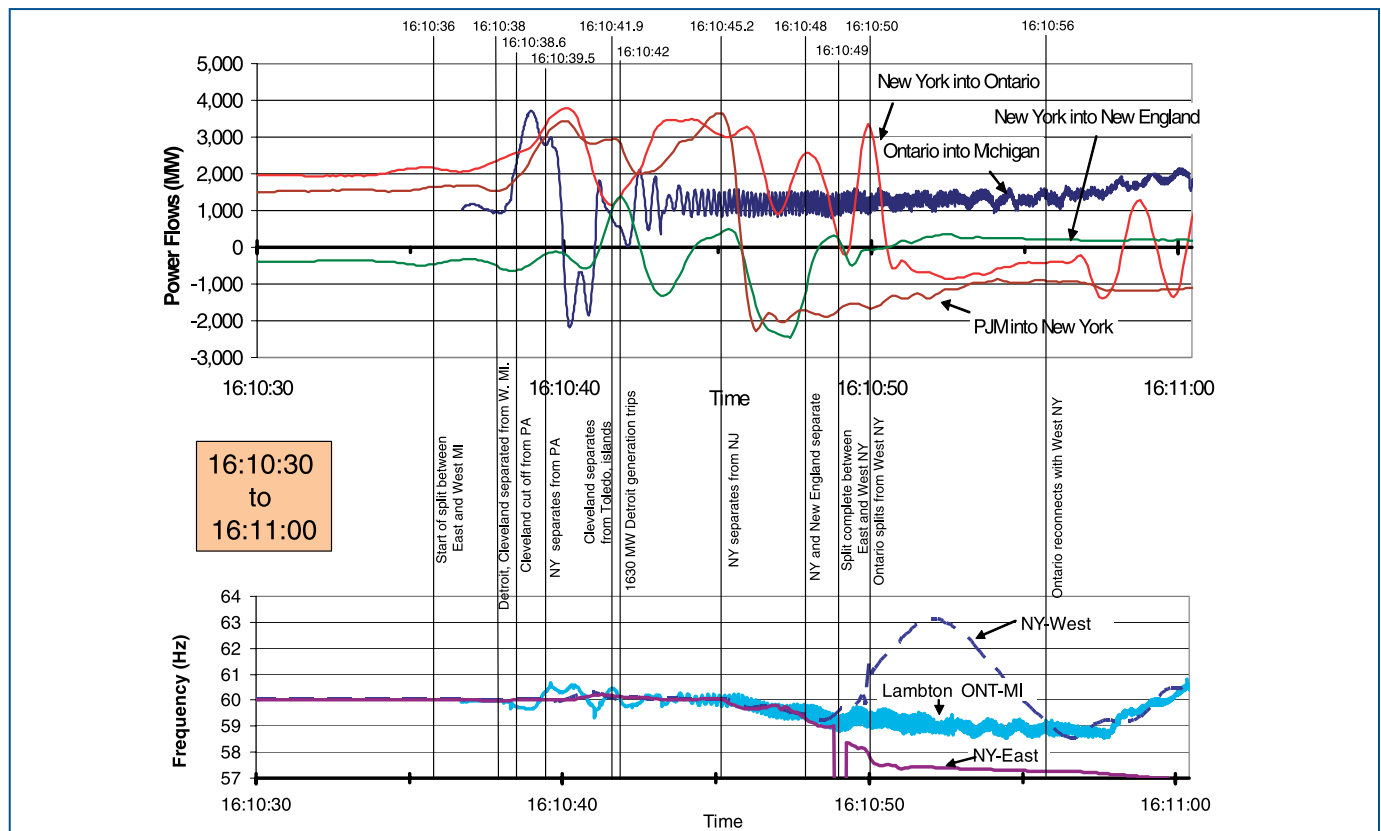

each interface varied over time, as did the amount of load that drew upon each interface, so net flows across each interface were not facing consistent demand with consistent capability as the cascade progressed. Second, the speed and magnitude of the swing was moderated by the inertia, reactive power capabilities, loading conditions and locations of the generators across the entire region.

After Cleveland was cut off from Pennsylvania and eastern power sources, Figure 6.17 shows the start of the dynamic power swing at 16:10:38.6. Because the loads of Cleveland, Toledo and Detroit (less the load already blacked out) were now hanging off Michigan and Ontario, this forced a gigantic shift in power flows to meet that demand. As noted above, flows from Ontario into Michigan increased from 1,000 MW to 3,700 MW shortly after the start of the swing, while flows from PJM into New York were close behind. But within two seconds from the start of the swing, at 16:10:40 EDT flows reversed and coursed back from Michigan into Ontario at the same time that frequency at the interface dropped, indicating that significant generation had been lost. Flows that had been westbound across the Ontario-Michigan interface by over 3,700 MW at 16:10:38.8 dropped down to 2,100 MW eastbound by 16:10:40, and then returned westbound starting at 16:10:40.5.

A series of circuits tripped along the border between PJM and the NYISO due to zone 1 impedance relay operations on overload and depressed voltage. The surge also moved into New England and the Maritimes region of Canada. The combination of the power surge and frequency rise caused 380 MW of pre-selected Maritimes generation to drop off-line due to the operation of the New Brunswick Power “Loss of Line 3001” Special Protection System. Although this system was designed to respond to failure of the 345-kV link between the Maritimes and New England, it operated in response to the effects of the power surge. The link remained intact during the event.

6D) Conditions in Northern Ohio and Eastern Michigan Degraded Further, With More Transmission Lines and Power Plants Failing: 16:10:39 to 16:10:46 EDT

Line trips in Ohio and eastern Michigan:

16:10:39.5 EDT: Bay Shore-Monroe 345-kV line

16:10:39.6 EDT: Allen Junction-Majestic-Monroe 345-kV line

16:10:40.0 EDT: Majestic-Lemoyne 345-kV line

Majestic 345-kV Substation: one terminal opened sequentially on all 345-kV lines

16:10:41.8 EDT: Fostoria Central-Galion 345-kV line

16:10:41.911 EDT: Beaver-Davis Besse 345-kV line

Under-frequency load-shedding in Ohio:

FirstEnergy shed 1,754 MVA load

AEP shed 133 MVA load

Seven power plants, for a total of 3,294 MW of generation, tripped off-line in Ohio:

16:10:42 EDT: Bay Shore Units 1-4 (551 MW near Toledo) tripped on over-excitation

16:10:40 EDT: Lakeshore unit 18 (156 MW, near Cleveland) tripped on under-frequency

16:10:41.7 EDT: Eastlake 1, 2, and 3 units (304 MW total, near Cleveland) tripped on under-frequency

16:10:41.7 EDT: Avon Lake unit 9 (580 MW, near Cleveland) tripped on under-frequency

16:10:41.7 EDT: Perry 1 nuclear unit (1,223 MW, near Cleveland) tripped on under-frequency

16:10:42 EDT: Ashtabula unit 5 (184 MW, near Cleveland) tripped on under-frequency

16:10:43 EDT: West Lorain units (296 MW) tripped on under-voltage

Four power plants producing 1,759 MW tripped off-line near Detroit:

16:10:42 EDT: Greenwood unit 1 tripped (253 MW) on low voltage, high current

16:10:41 EDT: Belle River unit 1 tripped (637 MW) on out-of-step

16:10:41 EDT: St. Clair unit 7 tripped (221 MW, DTE unit) on high voltage

16:10:42 EDT: Trenton Channel units 7A, 8 and 9 tripped (648 MW)

Back in northern Ohio, the trips of the Bay Shore-Monroe, Majestic-Lemoyne, Allen Junction-Majestic-Monroe 345-kV lines, and the Ashtabula 345/138-kV transformer cut off Toledo and Cleveland from the north, turning that area into an electrical island (Figure 6.18). Frequency in this large island began to fall rapidly. This caused a series of power plants in the area to trip

off-line due to the operation of under-frequency relays, including the Bay Shore units. When the Beaver-Davis Besse 345-kV line between Cleveland and Toledo tripped, it left the Cleveland area completely isolated and area frequency rapidly declined. Cleveland area load was disconnected by automatic under-frequency load-shedding (approximately 1,300 MW), and another 434 MW of load was interrupted after the generation remaining within this transmission “island” was tripped by under-frequency relays. This sudden load drop would contribute to the reverse power swing. In its own island, portions of Toledo blacked out from automatic under-frequency load-shedding but most of the Toledo load was restored by automatic reclosing of lines such as the East Lima-Fostoria Central 345-kV line and several lines at the Majestic 345-kV substation.

The Perry nuclear plant is in Ohio on Lake Erie, not far from the Pennsylvania border. The Perry plant was inside a decaying electrical island, and the plant tripped on under-frequency, as designed. A number of other units near Cleveland tripped off-line by under-frequency protection.

The tremendous power flow into Michigan, beginning at 16:10:38, occurred when Toledo and Cleveland were still connected to the grid only through Detroit. After the Bay Shore-Monroe line tripped at 16:10:39, Toledo-Cleveland were separated into their own island, dropping a large amount of load off the Detroit system. This left Detroit suddenly with excess generation, much of which was greatly accelerated in angle as the depressed voltage in Detroit (caused by the high demand in Cleveland) caused the Detroit units to pull nearly out of step. With the Detroit generators

running at maximum mechanical output, they began to pull out of synchronous operation with the rest of the grid. When voltage in Detroit returned to near-normal, the generators could not fully pull back its rate of revolutions, and ended up producing excessive temporary output levels, still out of step with the system. This is evident in Figure 6.19, which shows at least two sets of generator “pole slips” by plants in the Detroit area between 16:10:40 EDT and 16:10:42 EDT. Several large units around Detroit—Belle River, St. Clair, Greenwood, Monroe, and Fermi—all tripped in response. After formation of the Cleveland-Toledo island at 16:10:40 EDT, Detroit frequency spiked to almost 61.7 Hz before dropping, momentarily equalized between the Detroit and Ontario systems, but Detroit frequency began to decay at 2 Hz/sec and the generators then experienced under-speed conditions.

Re-examination of Figure 6.17 shows the power swing from the northeast through Ontario into Michigan and northern Ohio that began at 16:10:37, and how it reverses and swings back around Lake Erie at 16:10:39 EDT. That return was caused by the combination of natural oscillations, accelerated by major load losses, as the northern Ohio system disconnected from Michigan. It caused a power flow change of 5,800 MW, from 3,700 MW westbound to 2,100 eastbound across the Ontario to Michigan border between 16:10:39.5 and 16:10:40 EDT. Since the system was now fully dynamic, this large oscillation eastbound would lead naturally to a rebound, which began at 16:10:40 EDT with an inflection point reflecting generation shifts between Michigan and Ontario and additional line losses in Ohio.

Figure 6.18. Cleveland and Toledo Islanded, 16:10:39 to 16:10:46 EDT

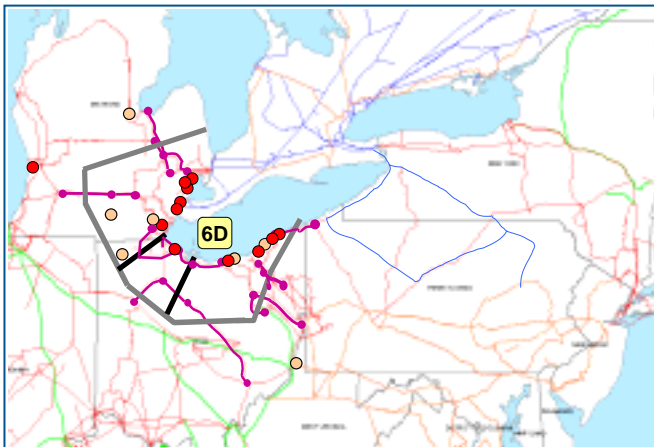
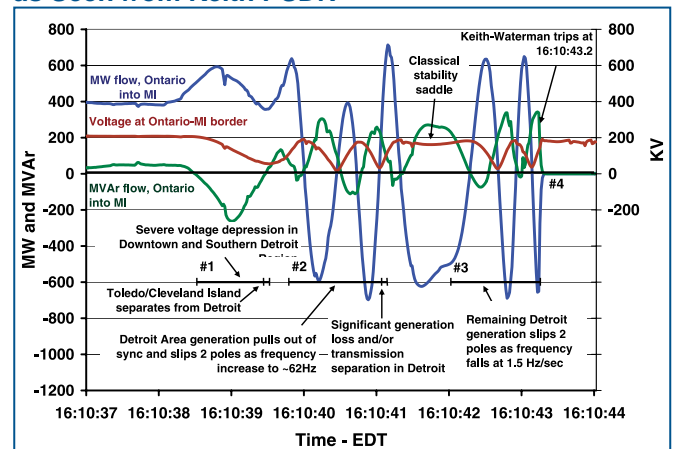

Figure 6.19. Generators Under Stress in Detroit, as Seen from Keith PSDR



Western Pennsylvania Separated from New York: 16:10:39 EDT to 16:10:44 EDT

- 6E) 16:10:39 EDT, Homer City-Watercure Road 345 kV
16:10:39 EDT: Homer City-Stolle Road 345 kV
- 6F) 16:10:44 EDT: South Ripley-Erie East 230 kV, and South Ripley-Dunkirk 230 kV
16:10:44 EDT: East Towanda-Hillside 230 kV

Responding to the swing of power out of Michigan toward Ontario and into New York and PJM, zone 1 relays on the 345-kV lines separated Pennsylvania from New York (Figure 6.20). Homer City-Watercure (177 miles or 285 km) and Homer City-Stolle Road (207 miles or 333 km) are very long lines and so have high impedance. Zone 1 relays do not have timers, and operate instantly when a power swing enters the relay target circle. For normal length lines, zone 1 relays have small target circles because the relay is measuring a less than the full length of the line—but for a long line the large line impedance enlarges the relay’s target circle and makes it more likely to be hit by the power swing. The Homer City-Watercure and Homer City-Stolle Road lines do not have zone 3 relays.

Given the length and impedance of these lines, it was highly likely that they would trip and separate early in the face of such large power swings. Most of the other interfaces between regions are on short ties—for instance, the ties between New York and Ontario and Ontario to Michigan are only about 2 miles (3.2 km) long, so they are electrically very short and thus have much lower impedance and trip less easily than these long lines. A zone 1 relay target for a short line covers a

small area so a power swing is less likely to enter the relay target circle at all, averting a zone 1 trip.

At 16:10:44 EDT, the northern part of the Eastern Interconnection (including eastern Michigan) was connected to the rest of the Interconnection at only two locations: (1) in the east through the 500-kV and 230-kV ties between New York and northeast New Jersey, and (2) in the west through the long and electrically fragile 230-kV transmission path connecting Ontario to Manitoba and Minnesota. The separation of New York from Pennsylvania (leaving only the lines from New Jersey into New York connecting PJM to the northeast) buffered PJM in part from these swings. Frequency was high in Ontario at that point, indicating that there was more generation than load, so much of this flow reversal never got past Ontario into New York.

6G) Transmission paths disconnected in New Jersey and northern Ontario, isolating the northeast portion of the Eastern Interconnection: 16:10:43 to 16:10:45 EDT

- 16:10:43 EDT: Keith-Waterman 230-kV line tripped
- 16:10:45 EDT: Wawa-Marathon 230-kV lines tripped
- 16:10:45 EDT: Branchburg-Ramapo 500-kV line tripped

At 16:10:43 EDT, eastern Michigan was still connected to Ontario, but the Keith-Waterman 230-kV line that forms part of that interface disconnected due to apparent impedance (Figure 6.21). This put more power onto the remaining interface between Ontario and Michigan, but

Figure 6.20. Western Pennsylvania Separates from New York, 16:10:39 EDT to 16:10:44 EDT

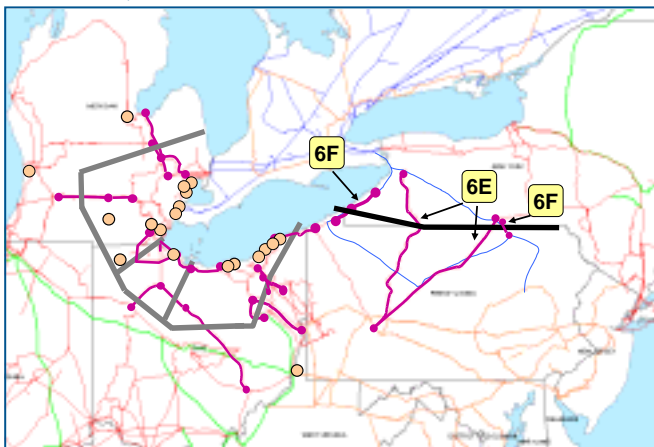
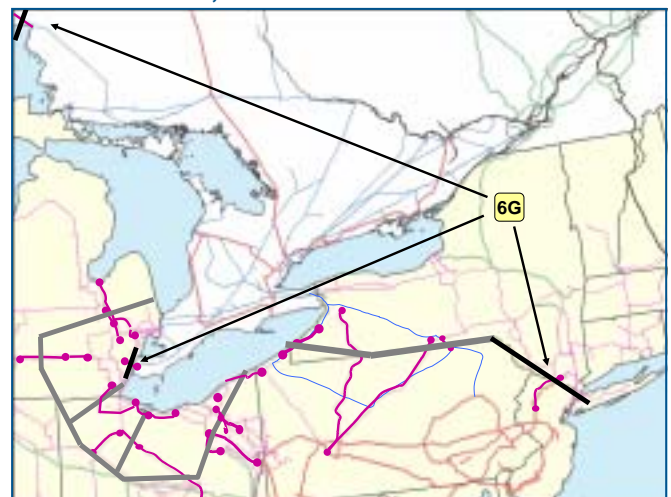

Figure 6.21. Northeast Separates from Eastern Interconnection, 16:10:45 EDT



triggered sustained oscillations in both power flow and frequency along the remaining 230-kV line.

At 16:10:45 EDT, northwest Ontario separated from the rest of Ontario when the Wawa-Marathon 230-kV lines (104 miles or 168 km long) disconnected along the northern shore of Lake Superior, tripped by zone 1 distance relays at both ends. This separation left the loads in the far northwest portion of Ontario connected to the Manitoba and Minnesota systems, and protected them from the blackout.

The 69-mile (111 km) long Branchburg-Ramapo 500-kV line and Ramapo transformer between New Jersey and New York was the last major transmission path remaining between the Eastern Interconnection and the area ultimately affected by the blackout. Figure 6.22 shows how that line disconnected at 16:10:45 EDT, along with other underlying 230 and 138-kV lines in northeast New Jersey. Branchburg-Ramapo was carrying over 3,000 MVA and 4,500 amps with voltage at 79% before it tripped, either on a high-speed swing into zone 1 or on a direct transfer trip. The investigation team is still examining why the higher impedance 230-kV overhead lines tripped while the underground Hudson-Farragut 230-kV cables did not; the available data suggest that the notably lower impedance of underground cables made these less vulnerable to the electrical strain placed on the system.

This left the northeast portion of New Jersey connected to New York, while Pennsylvania and the rest of New Jersey remained connected to the rest of the Eastern Interconnection. Within northeast

New Jersey, the separation occurred along the 230-kV corridors which are the main supply feeds into the northern New Jersey area (the two Roseland-Athenia circuits and the Linden-Bayway circuit). These circuits supply the large customer load in northern New Jersey and are a primary route for power transfers into New York City, so they are usually more highly loaded than other interfaces. These lines tripped west and south of the large customer loads in northeast New Jersey.

The separation of New York, Ontario, and New England from the rest of the Eastern Interconnection occurred due to natural breaks in the system and automatic relay operations, which performed exactly as they were designed to. No human intervention occurred by operators at PJM headquarters or elsewhere to effect this split. At this point, the Eastern Interconnection was divided into two major sections. To the north and east of the separation point lay New York City, northern New Jersey, New York state, New England, the Canadian Maritime Provinces, eastern Michigan, the majority of Ontario, and the Québec system.

The rest of the Eastern Interconnection, to the south and west of the separation boundary, was not seriously affected by the blackout. Frequency in the Eastern Interconnection was 60.3 Hz at the time of separation; this means that approximately 3,700 MW of excess generation that was on-line to export into the northeast was now in the main Eastern Island, separated from the load it had been serving. This left the northeast island with even less in-island generation on-line as it attempted to rebalance in the next phase of the cascade.

Figure 6.22. PJM to New York Interties Disconnect

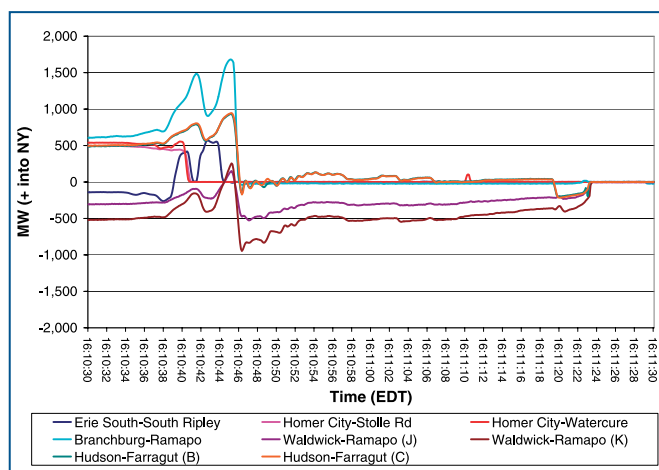

Note: The data in this figure come from the NYISO Energy Management System SDAC high speed analog system, which records 10 samples per second.

Phase 7: Several Electrical Islands Formed in Northeast U.S. and Canada: 16:10:46 EDT to 16:12 EDT

Overview of This Phase

During the next 3 seconds, the islanded northern section of the Eastern Interconnection broke apart internally. Figure 6.23 illustrates the events of this phase.

- 7A) New York-New England upstate transmission lines disconnected: 16:10:46 to 16:10:47 EDT
- 7B) New York transmission system split along Total East interface: 16:10:49 EDT

- 7C) The Ontario system just west of Niagara Falls and west of St. Lawrence separated from the western New York island: 16:10:50 EDT
- 7D) Southwest Connecticut separated from New York City: 16:11:22 EDT
- 7E) Remaining transmission lines between Ontario and eastern Michigan separated: 16:11:57 EDT

By this point most portions of the affected area were blacked out.

If the 6th phase of the cascade was about dynamic system oscillations, the last phase is a story of the search for balance between loads and generation. Here it is necessary to understand three matters related to system protection—why the blackout stopped where it did, how and why under-voltage and under-frequency load-shedding work, and what happened to the generators on August 14 and why. These matter because loads and generation must ultimately balance in real-time to remain stable. When the grid is breaking apart into islands, if generators stay on-line longer, then the better the chances to keep the lights on within each island and restore service following a blackout; so automatic load-shedding, transmission relay protections and generator protections must avoid premature tripping. They must all be coordinated to reduce the likelihood of system break-up, and once break-up occurs, to maximize an island’s chances for electrical survival.

Why the Blackout Stopped Where It Did

Extreme system conditions can damage equipment in several ways, from melting aluminum conductors (excessive currents) to breaking turbine blades on a generator (frequency excursions). The power system is designed to ensure that if conditions on the grid (excessive or inadequate voltage, apparent impedance or frequency) threaten the safe operation of the transmission lines, transformers, or power plants, the threatened equipment automatically separates from the network to protect itself from physical damage. Relays are the devices that effect this protection.

Generators are usually the most expensive units on an electrical system, so system protection schemes are designed to drop a power plant off the system as a self-protective measure if grid conditions become unacceptable. This protective

measure leaves the generator in good condition to help rebuild the system once a blackout is over and restoration begins. When unstable power swings develop between a group of generators that are losing synchronization (unable to match frequency) with the rest of the system, one effective way to stop the oscillations is to stop the flows entirely by disconnecting the unstable generators from the remainder of the system. The most common way to protect generators from power oscillations is for the transmission system to detect the power swings and trip at the locations detecting the swings—ideally before the swing reaches critical levels and harms the generator or the system.

On August 14, the cascade became a race between the power surges and the relays. The lines that tripped first were generally the longer lines with relay settings using longer apparent impedance tripping zones and normal time settings. On August 14, relays on long lines such as the Homer City-Watercure and the Homer City-Stolle Road 345-kV lines in Pennsylvania, that are not highly integrated into the electrical network, tripped quickly and split the grid between the sections that blacked out and those that recovered without further propagating the cascade. This same phenomenon was seen in the Pacific Northwest blackouts of 1996, when long lines tripped before more networked, electrically supported lines.

Transmission line voltage divided by its current flow is called “apparent impedance.” Standard transmission line protective relays continuously measure apparent impedance. When apparent impedance drops within the line’s protective relay set-points for a given period of time, the relays trip

Figure 6.23. New York and New England Separate, Multiple Islands Form

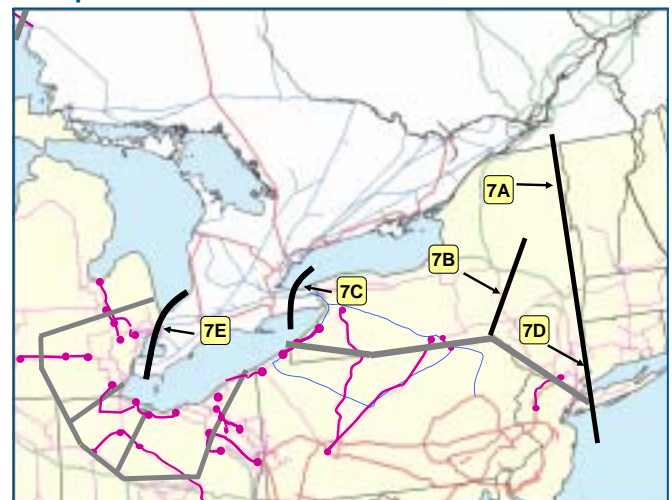

the line. The vast majority of trip operations on lines along the blackout boundaries between PJM and New York (for instance) show high-speed relay targets which indicate that a massive power surge caused each line to trip. To the relays, this power surge altered the voltages and currents enough that they appeared to be faults. The power surge was caused by power flowing to those areas that were generation-deficient (Cleveland, Toledo and Detroit) or rebounding back. These flows occurred purely because of the physics of power flows, with no regard to whether the power flow had been scheduled, because power flows from areas with excess generation into areas that were generation-deficient.

Protective relay settings on transmission lines operated as they were designed and set to behave on August 14. In some cases line relays did not trip in the path of a power surge because the apparent impedance on the line was not low enough—not because of the magnitude of the current, but rather because voltage on that line was high enough that the resulting impedance was adequate to avoid entering the relay’s target zone. Thus relative voltage levels across the northeast also affected which areas blacked out and which areas stayed on-line.

In the U.S. Midwest, as voltage levels declined many generators in the affected area were operating at maximum reactive power output before the blackout. This left the system little slack to deal with the low voltage conditions by ramping up more generators to higher reactive power output levels, so there was little room to absorb any system “bumps” in voltage or frequency. In contrast, in the northeast—particularly PJM, New York, and ISO-New England—operators were anticipating high power demands on the afternoon of August 14, and had already set up the system to maintain higher voltage levels and therefore had more reactive reserves on-line in anticipation of later afternoon needs. Thus, when the voltage and frequency swings began, these systems had reactive power readily available to help buffer their areas against potential voltage collapse without widespread generation trips.

The investigation team has used simulation to examine whether special protection schemes, designed to detect an impending cascade and separate the grid at specific interfaces, could have been or should be set up to stop a power surge and prevent it from sweeping through an interconnection and causing the breadth of line and generator trips and islanding that occurred that day. The

team has concluded that such schemes would have been ineffective on August 14.

Under-Frequency and Under-Voltage Load-Shedding

Automatic load-shedding measures are designed into the electrical system to operate as a last resort, under the theory that it is wise to shed some load in a controlled fashion if it can forestall the loss of a great deal of load to an uncontrollable cause. Thus there are two kinds of automatic load-shedding installed in North America—under-voltage load-shedding, which sheds load to prevent local area voltage collapse, and under-frequency load-shedding, which is designed to rebalance load and generation within an electrical island once it has been created by a system disturbance.

Automatic under-voltage load-shedding (UVLS) responds directly to voltage conditions in a local area. UVLS drops several hundred MW of load in pre-selected blocks within urban load centers, triggered in stages when local voltage drops to a designated level—likely 89 to 92% or even higher—with a several second delay. The goal of a UVLS scheme is to eliminate load in order to restore reactive power relative to demand, to prevent voltage collapse and contain a voltage problem within a local area rather than allowing it to spread in geography and magnitude. If the first load-shed step does not allow the system to rebalance, and voltage continues to deteriorate, then the next block of UVLS is dropped. Use of UVLS is not mandatory, but is done at the option of the control area and/or reliability council. UVLS schemes and trigger points should be designed to respect the local area’s system vulnerabilities, based on voltage collapse studies.

Recommendation
21, page 158

As noted in Chapter 4, there is no UVLS system in place within Cleveland and Akron; had such a scheme been implemented before August, 2003, shedding 1,500 MW of load in that area before the loss of the Sammis-Star line might have prevented the cascade and blackout.

In contrast to UVLS, automatic under-frequency load-shedding (UFLS) is designed for use in extreme conditions to stabilize the balance between generation and load after an electrical island has been formed, dropping enough load to allow frequency to stabilize within the island. All synchronous generators in North America are designed to operate at 60 cycles per second

(Hertz) and frequency reflects how well load and generation are balanced—if there is more load than generation at any moment, frequency drops below 60 Hz, and it rises above that level if there is more generation than load. By dropping load to match available generation within the island, UFLS is a safety net that helps to prevent the complete blackout of the island, which allows faster system restoration afterward. UFLS is not effective if there is electrical instability or voltage collapse within the island.

Today, UFLS installation is a NERC requirement, designed to shed at least 25-30% of the load in steps within each reliability coordinator region. These systems are designed to drop pre-designated customer load automatically if frequency gets too low (since low frequency indicates too little generation relative to load), starting generally when frequency reaches 59.3 Hz. Progressively more load is set to drop as frequency levels fall farther. The last step of customer load shedding is set at the frequency level just above the set point for generation under-frequency protection relays (57.5 Hz), to prevent frequency from falling so low that generators could be damaged (see Figure 2.4).

In NPCC, following the Northeast blackout of 1965, the region adopted automatic under-frequency load-shedding criteria and manual load-shedding within ten minutes to prevent a recurrence of the cascade and better protect system equipment from damage due to a high-speed system collapse. Under-frequency load-shedding triggers vary by regional reliability council—New York and all of the Northeast Power Coordinating Council, plus the Mid-Atlantic Area Council use 59.3 Hz as the first step for UFLS, while ECAR uses 59.5 Hz as their first step for UFLS.

The following automatic UFLS operated on the afternoon of August 14:

- ◆ Ohio shed over 1,883 MVA beginning at 16:10:39 EDT
- ◆ Michigan shed a total of 2,835 MW
- ◆ New York shed a total of 10,648 MW in numerous steps, beginning at 16:10:48
- ◆ PJM shed a total of 1,324 MVA in 3 steps in northern New Jersey beginning at 16:10:48 EDT
- ◆ Ontario shed a total of 7,800 MW in 2 steps, beginning at 16:10:4
- ◆ New England shed a total of 1,098 MW.

It must be emphasized that the entire northeast system was experiencing large scale, dynamic oscillations in this period. Even if the UFLS and generation had been perfectly balanced at any moment in time, these oscillations would have made stabilization difficult and unlikely.

Why the Generators Tripped Off

At least 265 power plants with more than 508 individual generating units shut down in the August 14 blackout. These U.S. and Canadian plants can be categorized as follows:

By reliability coordination area:

- ◆ Hydro Québec, 5 plants (all isolated onto the Ontario system)⁴
- ◆ Ontario, 92 plants
- ◆ ISO-New England, 31 plants
- ◆ MISO, 32 plants
- ◆ New York ISO, 70 plants
- ◆ PJM, 35 plants

By type:

- ◆ Conventional steam units, 66 plants (37 coal)
- ◆ Combustion turbines, 70 plants (37 combined cycle)
- ◆ Nuclear, 10 plants—7 U.S. and 3 Canadian, totaling 19 units (the nuclear unit outages are discussed in Chapter 8)
- ◆ Hydro, 101
- ◆ Other, 18.

Within the overall cascade sequence, 29 (6%) generators tripped between the start of the cascade at 16:05:57 (the Sammis-Star trip) and the split between Ohio and Pennsylvania at 16:10:38.6 EDT (Erie West-Ashtabula-Perry), which triggered the first big power swing. These trips were caused by the generators' protective relays responding to overloaded transmission lines, so many of these trips were reported as under-voltage or over-current. The next interval in the cascade was as the portions of the grid lost synchronism, from 16:10:38.6 until 16:10:45.2 EDT, when Michigan-New York-Ontario-New England separated from the rest of the Eastern Interconnection. Fifty more generators (10%) tripped as the islands formed, particularly due to changes in configuration, loss of synchronism, excitation system failures, with some under-frequency and under-voltage. In the third phase of generator losses, 431 generators (84%) tripped after the islands formed,

many at the same time that under-frequency load-shedding was occurring. This is illustrated in Figure 6.24. It is worth noting, however, that many generators did not trip instantly after the trigger condition that led to the trip—rather, many relay protective devices operate on time delays of milliseconds to seconds in duration, so that a generator that reported tripping at 16:10:43 on under-voltage or “generator protection” might have experienced the trigger for that condition several seconds earlier.

The high number of generators that tripped before formation of the islands helps to explain why so much of the northeast blacked out on August 14—many generators had pre-designed protection points that shut the unit down early in the cascade, so there were fewer units on-line to prevent island formation or to maintain balance between load and supply within each island after it formed. In particular, it appears that some generators tripped to protect the units from conditions that did not justify their protection, and many others were set to trip in ways that were not coordinated with the region’s under-frequency load-shedding, rendering that UFLS scheme less effective. Both factors compromised successful islanding and precipitated the blackouts in Ontario and New York.

Recommendation
21, page 158

Most of the unit separations fell in the category of consequential tripping—they tripped off-line in response to some outside condition on the grid, not because of any problem internal to the plant. Some generators became completely removed from all loads; because the fundamental operating principle of the grid is that load and generation must balance, if there was no load to be served the power plant shut down in response to over-speed and/or over-voltage protection schemes. Others were overwhelmed because they were among a few power plants within an electrical island, and were suddenly called on to serve huge customer loads, so the imbalance caused them to trip on under-frequency and/or under-voltage protection. A few were tripped by special protection schemes that activated on excessive frequency or loss of pre-studied major transmission elements known to require large blocks of generation rejection.

The large power swings and excursions of system frequency put all the units in their path through a sequence of major disturbances that shocked several units into tripping. Plant controls had actuated fast governor action on several of these to turn back the throttle, then turn it forward, only to turn

it back again as some frequencies changed several times by as much as 3 Hz (about 100 times normal deviations). Figure 6.25 is a plot of the MW output and frequency for one large unit that nearly survived the disruption but tripped when in-plant hydraulic control pressure limits were eventually violated. After the plant control system called for shutdown, the turbine control valves closed and the generator electrical output ramped down to a preset value before the field excitation tripped and the generator breakers opened to disconnect the unit from the system. This also illustrates the time lag between system events and the generator reaction—this generator was first disturbed by system conditions at 16:10:37, but did not trip until 16:11:47, over a minute later.

Under-frequency (10% of the generators reporting) and under-voltage (6%) trips both reflect responses to system conditions. Although combustion turbines in particular are designed with under-voltage relay protection, it is not clear why this is needed. An under-voltage condition by itself and over a set time period may not necessarily be a generator hazard (although it could affect plant auxiliary systems). Some generator under-voltage relays were set to trip at or above 90% voltage. However, a motor stalls out at about 70% voltage and a motor starter contactor drops out around 75%, so if there is a compelling need to protect the turbine from the system the under-voltage trigger point should be no higher than 80%.

An excitation failure is closely related to a voltage trip. As local voltages decreased, so did frequency. Over-excitation operates on a calculation of volts/hertz, so as frequency declines faster than voltage over-excitation relays would operate. It is not clear that these relays were coordinated with each machine’s exciter controls, to be sure that it was protecting the machine for the proper range of its control capabilities. Large units have two relays to detect volts/Hz—one at the generator and one at the transformer, each with a slightly different volts/Hz setting and time delay. It is possible that these settings can cause a generator to trip within a generation-deficient island as frequency is attempting to rebalance, so these settings should be carefully evaluated.

The Eastlake 5 trip at 13:31 EDT was an excitation system failure—as voltage fell at the generator bus, the generator tried to increase quickly its production of voltage on the AC winding of the machine quickly. This caused the generator’s excitation protection scheme to trip the plant off to

Figure 6.24. Generator Trips by Time and Cause

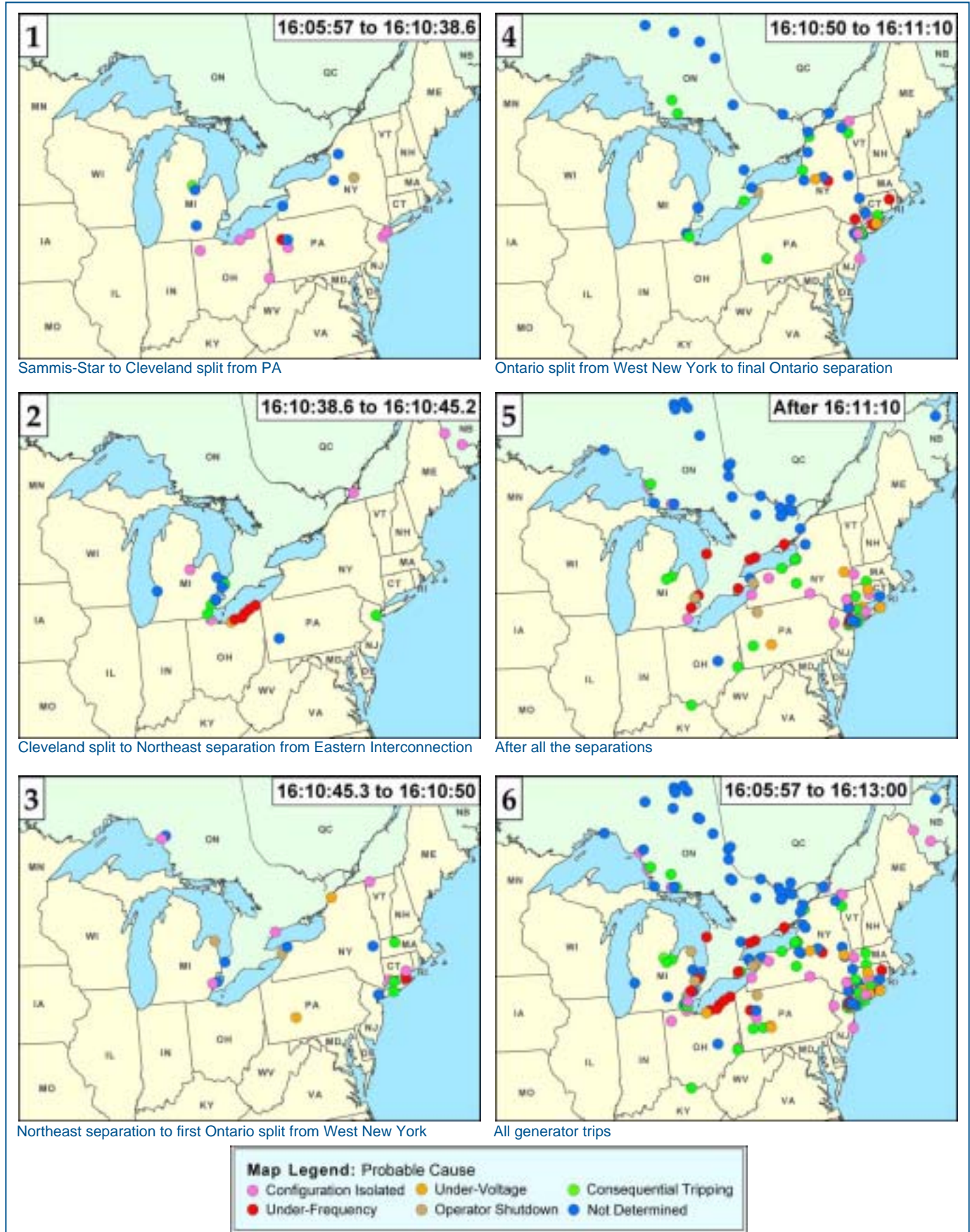

protect its windings and coils from over-heating. Several of the other generators which tripped early in the cascade came off under similar circumstances as excitation systems were overstressed to hold voltages up. Seventeen generators reported tripping for over-excitation. Units that trip for a cause related to frequency should be evaluated to determine how the unit frequency triggers coordinate with the region's under-frequency load-shedding scheme, to assure that the generator trips are sequenced to follow rather than precede load-shedding. After UFLS operates to drop a large block of load, frequency continues to decline for several cycles before rebounding, so it is necessary to design an adequate time delay into generators' frequency-related protections to keep it on-line long enough to help rebalance against the remaining load.

Fourteen generators reported tripping for under-excitation (also known as loss of field), which protects the generator from exciter component failures. This protection scheme can operate on stable as well as transient power swings, so should be examined to determine whether the protection settings are appropriate. Eighteen units—primarily combustion turbines—reported over-current as the reason for relay operation.

Some generators in New York failed in a way that exacerbated frequency decay. A generator that tripped due to a boiler or steam problem may have done so to prevent damage due to over-speed and limit impact to the turbine-generator shaft when the breakers are opened, and it will attempt to maintain its synchronous speed until the generator is tripped. To do this, the mechanical part of the system would shut off the steam flow. This causes the generator to consume a small amount

Figure 6.25. Events at One Large Generator During the Cascade

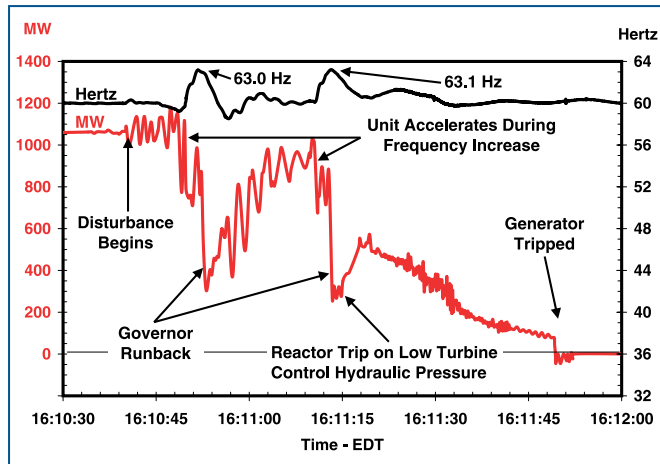

of power off the grid to support the unit's orderly slow-down and trip due to reverse power flow. This is a standard practice to avoid turbine over-speed. Also within New York, 16 gas turbines totaling about 400 MW reported tripping for loss of fuel supply, termed "flame out." These units' trips should be better understood.

Another reason for power plant trips was actions or failures of plant control systems. One common cause in this category was a loss of sufficient voltage to in-plant loads. Some plants run their internal cooling and processes (house electrical load) off the generator or off small, in-house auxiliary generators, while others take their power off the main grid. When large power swings or voltage drops reached these plants in the latter category, they tripped off-line because the grid could not supply the plant's in-house power needs reliably. At least 17 units reported tripping due to loss of system configuration, including the loss of a transmission or distribution line to serve the in-plant loads. Some generators were tripped by their operators.

Recommendation
11, page 148

Unfortunately, 40% of the generators that went off-line during or after the cascade did not provide useful information on the cause of tripping in their response to the NERC investigation data request. While the responses available offer significant and valid information, the investigation team will never be able to fully analyze and explain why so many generators tripped off-line so early in the cascade, contributing to the speed and extent of the blackout. It is clear that every generator should have some minimum of protection for stator differential, loss of field, and out-of-step protection, to disconnect the unit from the grid when it is not performing correctly, and also protection for protect the generator from extreme conditions on the grid that could cause catastrophic damage to the generator. These protections should be set tight enough to protect the unit from the grid, but also wide enough to assure that the unit remains connected to the grid as long as possible. This coordination is a risk management issue that must balance the needs of the grid and customers relative to the needs of the individual assets.

Recommendation
21, page 158

Key Phase 7 Events

Electric loads and flows do not respect political boundaries. After the blackout of 1965, as loads

grew within New York City and neighboring northern New Jersey, the utilities serving the area deliberately increased the integration between the systems serving this area to increase the flow capability into New York and the reliability of the system as a whole. The combination of the facilities in place and the pattern of electrical loads and flows on August 14 caused New York to be tightly linked electrically to northern New Jersey and southwest Connecticut, and moved the weak spots on the grid out past this combined load and network area.

Figure 6.26 gives an overview of the power flows and frequencies in the period 16:10:45 EDT through 16:11:00 EDT, capturing most of the key events in Phase 7.

7A) New York-New England Transmission Lines Disconnected: 16:10:46 to 16:10:54 EDT

Over the period 16:10:46 EDT to 16:10:54 EDT, the separation between New England and New York occurred. It occurred along five of the northern tie lines, and seven lines within southwest Connecticut. At the time of the east-west separation in New York at 16:10:49 EDT, New England was isolated

from the eastern New York island. The only remaining tie was the PV-20 circuit connecting New England and the western New York island, which tripped at 16:10:54 EDT. Because New England was exporting to New York before the disturbance across the southwest Connecticut tie, but importing on the Northwalk-Northport tie, the Pleasant Valley path opened east of Long Mountain—in other words, internal to southwest Connecticut—rather than along the actual New York-New England tie.⁵ Immediately before the separation, the power swing out of New England occurred because the New England generators had increased output in response to the drag of power through Ontario and New York into Michigan and Ohio.⁶ The power swings continuing through the region caused this separation, and caused Vermont to lose approximately 70 MW of load.

When the ties between New York and New England disconnected, most of the New England area along with Canada’s Maritime Provinces (New Brunswick and Nova Scotia) became an island with generation and demand balanced close enough that it was able to remain operational. The New England system had been exporting close to

Figure 6.26. Measured Power Flows and Frequency Across Regional Interfaces, 16:10:45 to 16:11:30 EDT, with Key Events in the Cascade

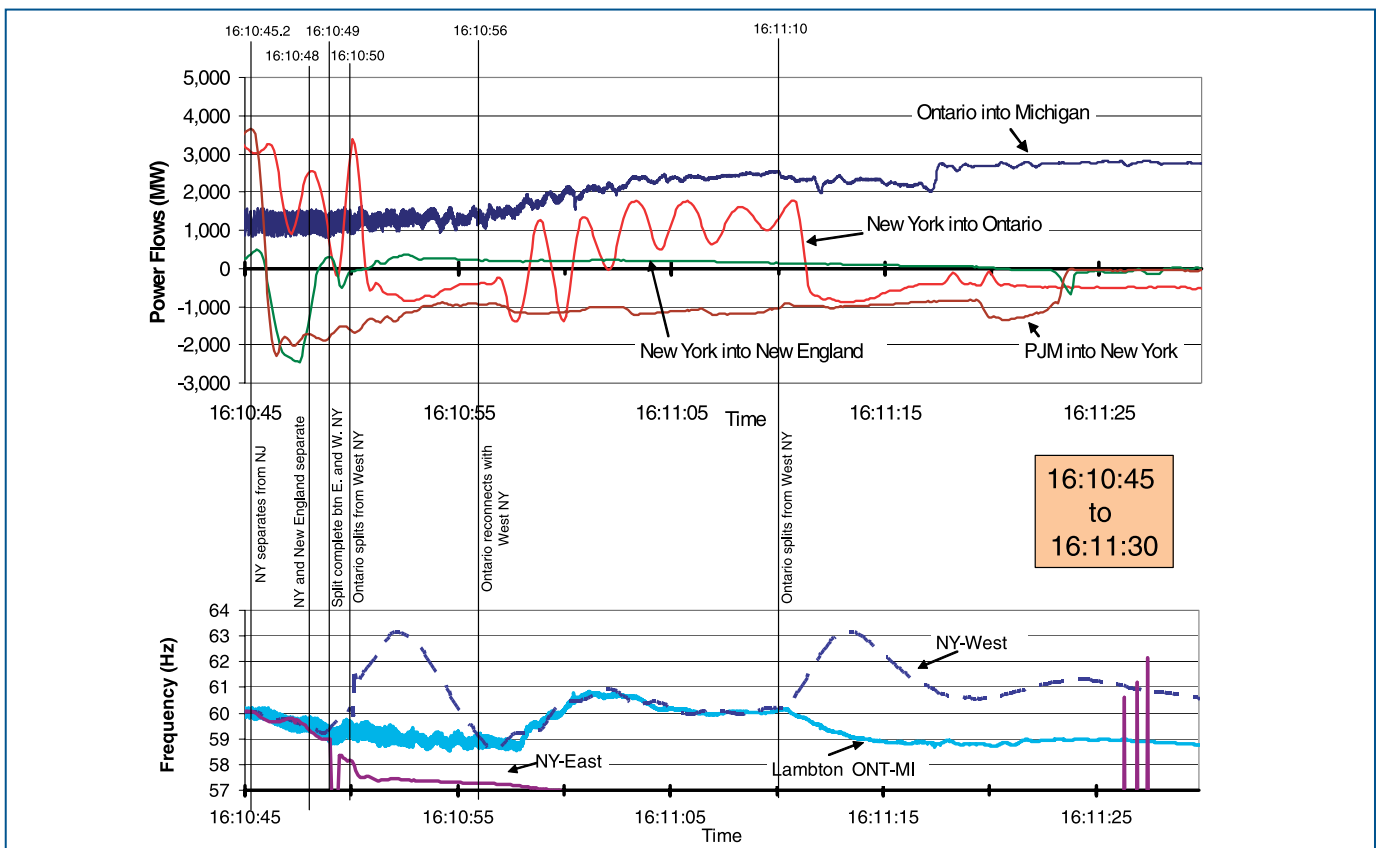

600 MW to New York, so it was relatively generation-rich and experienced continuing fluctuations until it reached equilibrium. Before the Maritimes and New England separated from the Eastern Interconnection at approximately 16:11 EDT, voltages became depressed across portions of New England and some large customers disconnected themselves automatically.⁷ However, southwestern Connecticut separated from New England and remained tied to the New York system for about one minute.

While frequency within New England wobbled slightly and recovered quickly after 16:10:40 EDT, frequency of the New York-Ontario-Michigan-Ohio island fluctuated severely as additional lines, loads and generators tripped, reflecting the severe generation deficiency in Michigan and Ohio.

Due to its geography and electrical characteristics, the Québec system in Canada is tied to the remainder of the Eastern Interconnection via high voltage DC (HVDC) links instead of AC transmission lines. Québec was able to survive the power surges with only small impacts because the DC connections shielded it from the frequency swings.

7B) New York Transmission Split East-West: 16:10:49 EDT

The transmission system split internally within New York along the Total East interface, with the eastern portion islanding to contain New York City, northern New Jersey, and southwestern Connecticut. The eastern New York island had been importing energy, so it did not have enough surviving generation on-line to balance load. Frequency declined quickly to below 58.0 Hz and triggered 7,115 MW of automatic UFLS.⁸ Frequency declined further, as did voltage, causing pre-designed trips at the Indian Point nuclear plant and other generators in and around New York City through 16:11:10 EDT. The western portion of New York remained connected to Ontario and eastern Michigan.

The electric system has inherent weak points that vary as a function of the characteristics of the physical lines and plants and the topology of the lines, loads and flows across the grid at any point in time. The weakest points on a system tend to be those points with the highest impedance, which routinely are long (over 50 miles or 80 km) overhead lines with high loading. When such lines have high-speed relay protections that may trip on

high current and overloads in addition to true faults, they will trip out before other lines in the path of large power swings such as the 3,500 MW power surge that hit New York on August 14. New York's Total East and Central East interfaces, where the internal split occurred, are routinely among the most heavily loaded paths in the state and are operated under thermal, voltage and stability limits to respect their relative vulnerability and importance.

Examination of the loads and generation in the Eastern New York island indicates before 16:10:00 EDT, the area had been importing electricity and had less generation on-line than load. At 16:10:50 EDT, seconds after the separation along the Total East interface, the eastern New York area had experienced significant load reductions due to under-frequency load-shedding—Consolidated Edison, which serves New York City and surrounding areas, dropped over 40% of its load on automatic UFLS. But at this time, the system was still experiencing dynamic conditions—as illustrated in Figure 6.26, frequency was falling, flows and voltages were oscillating, and power plants were tripping off-line.

Had there been a slow islanding situation and more generation on-line, it might have been possible for the Eastern New York island to rebalance given its high level of UFLS. But the available information indicates that events happened so quickly and the power swings were so large that rebalancing would have been unlikely, with or without the northern New Jersey and southwest Connecticut loads hanging onto eastern New York. This was further complicated because the high rate of change in voltages at load buses reduced the actual levels of load shed by UFLS relative to the levels needed and expected.

The team could not find any way that one electrical region might have protected itself against the August 14 blackout, either at electrical borders or internally. The team also looked at whether it was possible to design special protection schemes to separate one region from its neighborings proactively, to buffer itself from a power swing before it hit. This was found to be inadvisable for two reasons: (1) as noted above, the act of separation itself could cause oscillations and dynamic instability that could be as damaging to the system as the swing it was protecting against; and (2) there was no event or symptom on August 14 that could be used to trigger such a protection scheme in time.

7C) The Ontario System Just West of Niagara Falls and West of St. Lawrence Separated from the Western New York Island: 16:10:50 EDT

At 16:10:50 EDT, Ontario and New York separated west of the Ontario/New York interconnection, due to relay operations which disconnected nine 230-kV lines within Ontario. These left most of Ontario isolated to the north. Ontario's large Beck and Saunders hydro stations, along with some Ontario load, the New York Power Authority's (NYPA) Niagara and St. Lawrence hydro stations, and NYPA's 765-kV AC interconnection to their HVDC tie with Québec, remained connected to the western New York system, supporting the demand in upstate New York.

From 16:10:49 to 16:10:50 EDT, frequency in Ontario declined below 59.3 Hz, initiating automatic under-frequency load-shedding (3,000 MW). This load-shedding dropped about 12% of Ontario's remaining load. Between 16:10:50 EDT and 16:10:56 EDT, the isolation of Ontario's 2,300 MW Beck and Saunders hydro units onto the western New York island, coupled with under-frequency load-shedding in the western New York island, caused the frequency in this island to rise to 63.4 Hz due to excess generation relative to the load within the island (Figure 6.27). The high frequency caused trips of five of the U.S. nuclear units within the island, and the last one tripped on the second frequency rise.

Three of the tripped 230-kV transmission circuits near Niagara automatically reconnected Ontario to New York at 16:10:56 EDT by reclosing. Even with these lines reconnected, the main Ontario island (still attached to New York and eastern Michigan) was then extremely deficient in generation, so its frequency declined towards 58.8 Hz, the threshold for the second stage of under-frequency load-shedding. Within the next two seconds another 19% of Ontario demand (4,800 MW) automatically disconnected by under-frequency load-shedding. At 16:11:10 EDT, these same three lines tripped a second time west of Niagara, and New York and most of Ontario separated for a final time. Following this separation, the frequency in Ontario declined to 56 Hz by 16:11:57 EDT. With Ontario still supplying 2,500 MW to the Michigan-Ohio load pocket, the remaining ties with Michigan tripped at 16:11:57 EDT. Ontario system frequency declined, leading to a widespread shut-down at 16:11:58 EDT and the loss of 22,500 MW of load in Ontario, including the cities of Toronto, Hamilton, and Ottawa.

7D) Southwest Connecticut Separated from New York City: 16:11:22 EDT

In southwest Connecticut, when the Long Mountain-Plum Tree line (connected to the Pleasant Valley substation in New York) disconnected at 16:11:22 EDT, it left about 500 MW of southwest Connecticut demand supplied only through a 138-kV underwater tie to Long Island. About two seconds later, the two 345-kV circuits connecting southeastern New York to Long Island tripped, isolating Long Island and southwest Connecticut, which remained tied together by the underwater Norwalk Harbor-to-Northport 138-kV cable. The cable tripped about 20 seconds later, causing southwest Connecticut to black out.

Within the western New York island, the 345-kV system remained intact from Niagara east to the Utica area, and from the St. Lawrence/Plattsburgh area south to the Utica area through both the 765-kV and 230-kV circuits. Ontario's Beck and Saunders generation remained connected to New York at Niagara and St. Lawrence, respectively, and this island stabilized with about 50% of the pre-event load remaining. The boundary of this island moved southeastward as a result of the reclosure of Fraser-to-Coopers Corners 345-kV line at 16:11:23 EDT.

As a result of the severe frequency and voltage changes, many large generating units in New York and Ontario tripped off-line. The eastern island of New York, including the heavily populated areas of southeastern New York, New York City, and Long Island, experienced severe frequency and voltage declines. At 16:11:29 EDT, the New Scotland-to-Leeds 345-kV circuits tripped, separating the island into northern and southern sections. The small remaining load in the northern portion of the eastern island (the Albany area) retained

Figure 6.27. Frequency Separation Between Ontario and Western New York

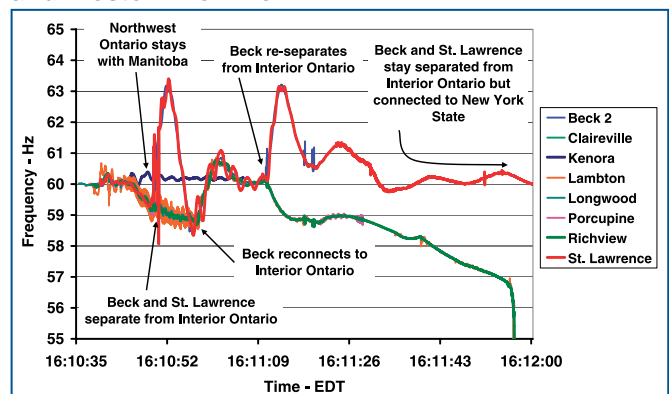

electric service, supplied by local generation until it could be resynchronized with the western New York island.

7E) Remaining Transmission Lines Between Ontario and Eastern Michigan Separated: 16:11:57 EDT

Before the blackout, New England, New York, Ontario, eastern Michigan, and northern Ohio were scheduled net importers of power. When the western and southern lines serving Cleveland, Toledo, and Detroit collapsed, most of the load remained on those systems, but some generation had tripped. This exacerbated the generation/load imbalance in areas that were already importing power. The power to serve this load came through the only major path available, via Ontario (IMO). After most of IMO was separated from New York and generation to the north and east, much of the Ontario load and generation was lost; it took only moments for the transmission paths west from Ontario to Michigan to fail.

When the cascade was over at about 16:12 EDT, much of the disturbed area was completely blacked out, but there were isolated pockets that still had service because load and generation had reached equilibrium. Ontario’s large Beck and Saunders hydro stations, along with some Ontario load, the New York Power Authority’s (NYPA) Niagara and St. Lawrence hydro stations, and NYPA’s 765-kV AC interconnection to the Québec HVDC tie, remained connected to the western New York system, supporting demand in upstate New York.

Electrical islanding. Once the northeast became isolated, it lost more and more generation relative to load as more and more power plants tripped

off-line to protect themselves from the growing disturbance. The severe swings in frequency and voltage in the area caused numerous lines to trip, so the isolated area broke further into smaller islands. The load/generation mismatch also affected voltages and frequency within these smaller areas, causing further generator trips and automatic under-frequency load-shedding, leading to blackout in most of these areas.

Figure 6.28 shows frequency data collected by the distribution-level monitors of Softswitching Technologies, Inc. (a commercial power quality company serving industrial customers) for the area affected by the blackout. The data reveal at least five separate electrical islands in the Northeast as the cascade progressed. The two paths of red diamonds on the frequency scale reflect the Albany area island (upper path) versus the New York City island, which declined and blacked out much earlier.

Cascading Sequence Essentially Complete: 16:13 EDT

Most of the Northeast (the area shown in gray in Figure 6.29) was now blacked out. Some isolated areas of generation and load remained on-line for several minutes. Some of those areas in which a close generation-demand balance could be maintained remained operational.

One relatively large island remained in operation serving about 5,700 MW of demand, mostly in western New York, anchored by the Niagara and St. Lawrence hydro plants. This island formed the basis for restoration in both New York and Ontario.

The entire cascade sequence is depicted graphically in Figure 6.30.

Figure 6.28. Electric Islands Reflected in Frequency Plot

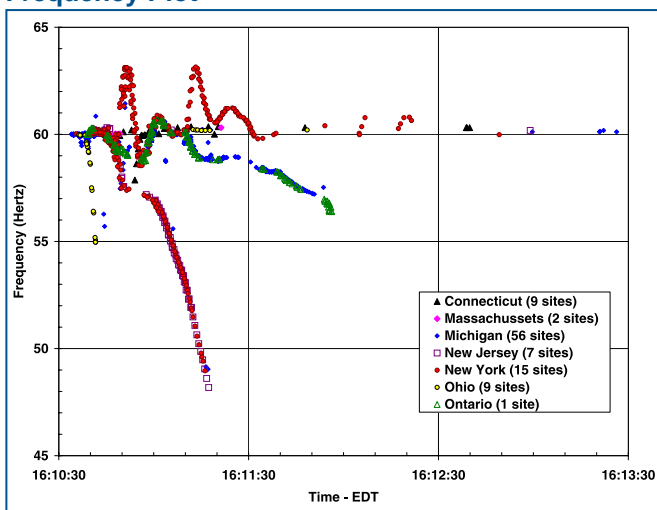
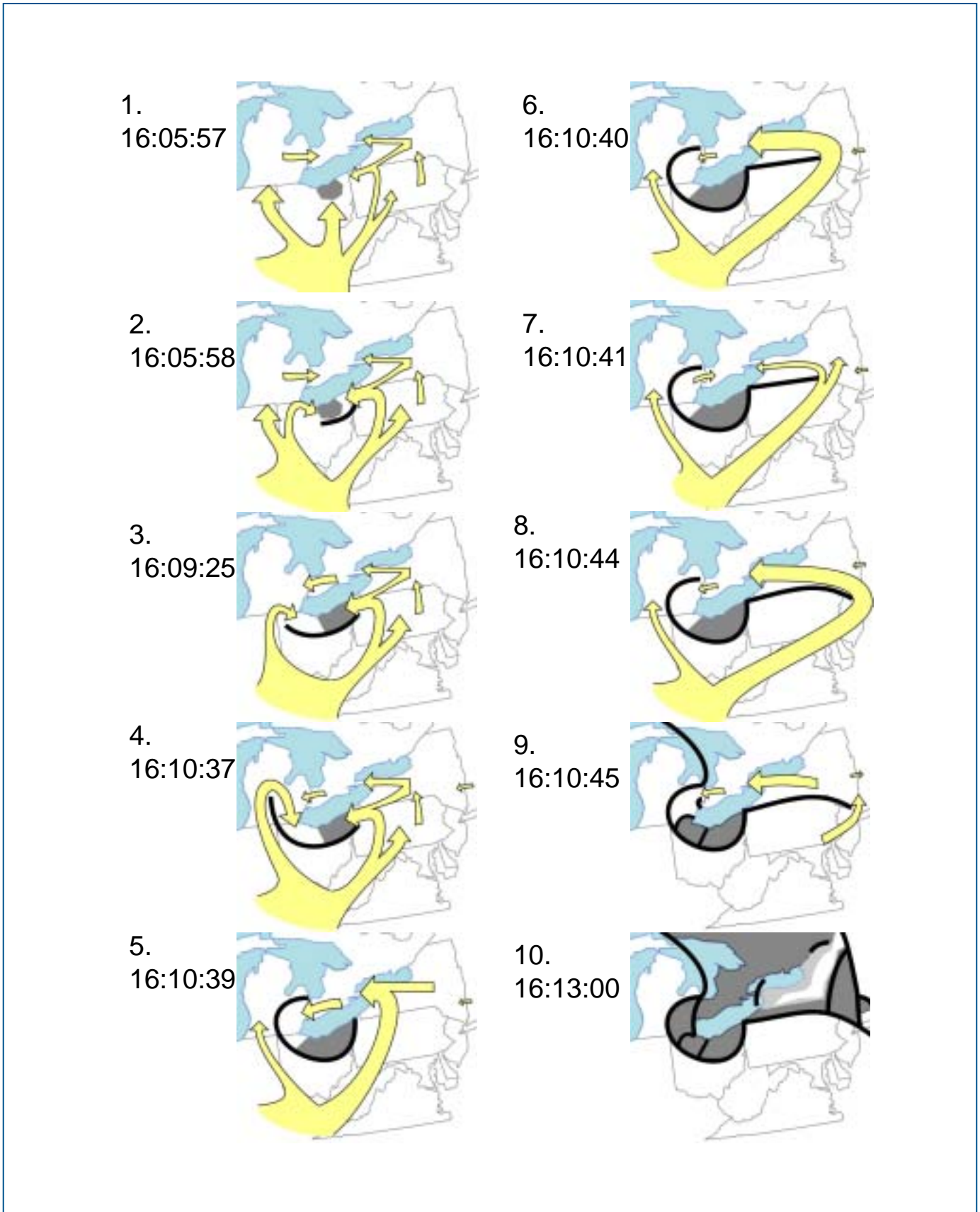

Figure 6.29. Area Affected by the Blackout



Figure 6.30. Cascade Sequence



Legend: Yellow arrows represent the overall pattern of electricity flows. Black lines represent approximate points of separation between areas within the Eastern Interconnect. Gray shading represents areas affected by the blackout.

Endnotes

¹ New York Independent System Operator, *Interim Report on the August 14, 2003 Blackout*, January 8, 2004, p. 14.

² *Ibid.*, p. 14.

³ These zone 2s are set on the 345-kV lines into the Argenta substation. The lines are owned by Michigan Electric Transmission Company and maintained by Consumers Power. Since the blackout occurred, Consumers Power has proactively changed the relay setting from 88 Ohms to 55 Ohms to reduce the reach of the relay. Source: Charles Rogers, Consumers Power.

⁴ The province of Québec, although considered a part of the Eastern Interconnection, is connected to the rest of the Eastern Interconnection only by DC ties. In this instance, the DC ties acted as buffers between portions of the Eastern Interconnection; transient disturbances propagate through them less readily. Therefore, the electricity system in Québec was not affected by the outage, except for a small portion of the province's load that is directly connected to Ontario by AC transmission lines. (Although DC ties can act as a buffer between systems, the tradeoff is that they do not allow instantaneous generation support following the unanticipated loss of a generating unit.)

⁵ New York Independent System Operator, *Interim Report on the August 14, 2003 Blackout*, January 8, 2004, p. 20.

⁶ *Ibid.*, p. 20.

⁷ After New England's separation from the Eastern Interconnection occurred, the next several minutes were critical to stabilizing the ISO-NE system. Voltages in New England recovered and over-shot to high due to the combination of load loss, capacitors still in service, lower reactive losses on the transmission system, and loss of generation to regulate system voltage. Over-voltage protective relays operated to trip both transmission and distribution capacitors. Operators in New England brought all fast-start generation on-line by 16:16 EDT. Much of the customer process load was automatically restored. This caused voltages to drop again, putting portions of New England at risk of voltage collapse. Operators manually dropped 80 MW of load in southwest Connecticut by 16:39 EDT, another 325 MW in Connecticut and 100 MW in western Massachusetts by 16:40 EDT. These measures helped to stabilize their island following their separation from the rest of the Eastern Interconnection.

⁸ New York Independent System Operator, *Interim Report on the August 14, 2003 Blackout*, January 8, 2004, p. 23.

7. The August 14 Blackout Compared With Previous Major North American Outages

Incidence and Characteristics of Power System Outages

Short, localized outages occur on power systems fairly frequently. System-wide disturbances that affect many customers across a broad geographic area are rare, but they occur more frequently than a normal distribution of probabilities would predict. North American power system outages between 1984 and 1997 are shown in Figure 7.1 by the number of customers affected and the rate of occurrence. While some of these were widespread weather-related events, some were cascading events that, in retrospect, were preventable. Electric power systems are fairly robust and are capable of withstanding one or two contingency events, but they are fragile with respect to multiple contingency events unless the systems are readjusted between contingencies. With the shrinking margin in the current transmission system, it is likely to be more vulnerable to cascading outages than it was in the past, unless effective countermeasures are taken.

As evidenced by the absence of major transmission projects undertaken in North America over the past 10 to 15 years, utilities have found ways to increase the utilization of their existing facilities to meet increasing demands without adding significant high-voltage equipment. Without intervention, this trend is likely to continue. Pushing the system harder will undoubtedly increase reliability challenges. Special protection schemes may be relied on more to deal with particular challenges, but the system still will be less able to withstand unexpected contingencies.

A smaller transmission margin for reliability makes the preservation of system reliability a harder job than it used to be. The system is being operated closer to the edge of reliability than it was just a few years ago. Table 7.1 represents some of the changed conditions that make the preservation of reliability more challenging.

Figure 7.1. North American Power System Outages, 1984-1997

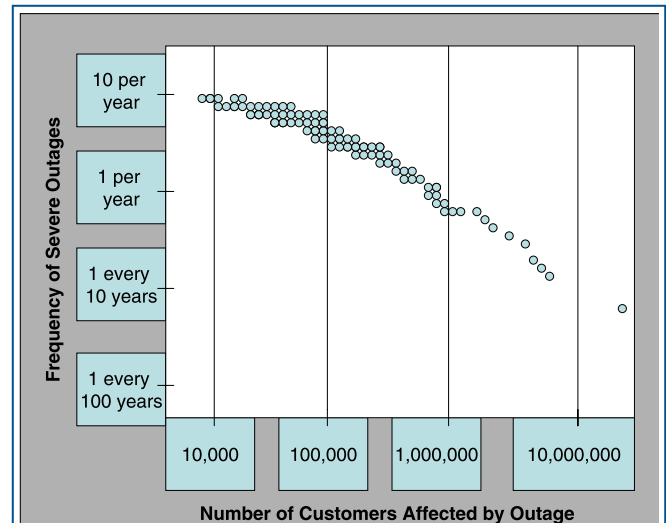

Note: The circles represent individual outages in North America between 1984 and 1997, plotted against the frequency of outages of equal or greater size over that period.

Source: Adapted from John Doyle, California Institute of Technology, "Complexity and Robustness," 1999. Data from NERC.

If nothing else changed, one could expect an increased frequency of large-scale events as compared to historical experience. The last and most extreme event shown in Figure 7.1 is the August 10, 1996, outage. August 14, 2003, surpassed that event in terms of severity. In addition, two significant outages in the month of September 2003 occurred abroad: one in England and one, initiated in Switzerland, that cascaded over much of Italy.

In the following sections, seven previous outages are reviewed and compared with the blackout of August 14, 2003: (1) Northeast blackout on November 9, 1965; (2) New York City blackout on July 13, 1977; (3) West Coast blackout on December 22, 1982; (4) West Coast blackout on July 2-3, 1996; (5) West Coast blackout on August 10, 1996; (6) Ontario and U.S. North Central blackout on June 25, 1998; and (7) Northeast outages and non-outage disturbances in the summer of 1999.

Outage Descriptions and Major Causal Factors

November 9, 1965: Northeast Blackout

This disturbance resulted in the loss of over 20,000 MW of load and affected 30 million people. Virtually all of New York, Connecticut, Massachusetts, Rhode Island, small segments of northern Pennsylvania and northeastern New Jersey, and substantial areas of Ontario, Canada, were affected. Outages lasted for up to 13 hours. This event resulted in the formation of the North American Electric Reliability Council in 1968.

A backup protective relay operated to open one of five 230-kV lines taking power north from a generating plant in Ontario to the Toronto area. When the flows redistributed instantaneously on the remaining four lines, they tripped out successively in a total of 2.5 seconds. The resultant power swings resulted in a cascading outage that blacked out much of the Northeast.

The major causal factors were as follows:

- ◆ Operation of a backup protective relay took a 230-kV line out of service when the loading on the line exceeded the 375-MW relay setting.
- ◆ Operating personnel were not aware of the operating set point of this relay.
- ◆ Another 230-kV line opened by an overcurrent relay action, and several 115- and 230-kV lines opened by protective relay action.

- ◆ Two key 345-kV east-west (Rochester-Syracuse) lines opened due to instability, and several lower voltage lines tripped open.
- ◆ Five of 16 generators at the St. Lawrence (Massena) plant tripped automatically in accordance with predetermined operating procedures.
- ◆ Following additional line tripouts, 10 generating units at Beck were automatically shut down by low governor oil pressure, and 5 pumping generators were tripped off by overspeed governor control.
- ◆ Several other lines then tripped out on under-frequency relay action.

July 13, 1977: New York City Blackout

This disturbance resulted in the loss of 6,000 MW of load and affected 9 million people in New York City. Outages lasted for up to 26 hours. A series of events triggering the separation of the Consolidated Edison system from neighboring systems and its subsequent collapse began when two 345-kV lines on a common tower in Northern Westchester were struck by lightning and tripped out. Over the next hour, despite Consolidated Edison dispatcher actions, the system electrically separated from surrounding systems and collapsed. With the loss of imports, generation in New York City was not sufficient to serve the load in the city.

Major causal factors were:

Table 7.1. Changing Conditions That Affect System Reliability

Previous Conditions	Emerging Conditions
Fewer, relatively large resources	Smaller, more numerous resources
Long-term, firm contracts	Contracts shorter in duration More non-firm transactions, fewer long-term firm transactions
Bulk power transactions relatively stable and predictable	Bulk power transactions relatively variable and less predictable
Assessment of system reliability made from stable base (narrower, more predictable range of potential operating states)	Assessment of system reliability made from variable base (wider, less predictable range of potential operating states)
Limited and knowledgeable set of utility players	More players making more transactions, some with less interconnected operation experience; increasing with retail access
Unused transmission capacity and high security margins	High transmission utilization and operation closer to security limits
Limited competition, little incentive for reducing reliability investments	Utilities less willing to make investments in transmission reliability that do not increase revenues
Market rules and reliability rules developed together	Market rules undergoing transition, reliability rules developed separately
Limited wheeling	More system throughput

- ◆ Two 345-kV lines connecting Buchanan South to Millwood West experienced a phase B to ground fault caused by a lightning strike.
- ◆ Circuit breaker operations at the Buchanan South ring bus isolated the Indian Point No. 3 generating unit from any load, and the unit tripped for a rejection of 883 MW of load.
- ◆ Loss of the ring bus isolated the 345-kV tie to Ladentown, which had been importing 427 MW, making the cumulative resources lost 1,310 MW.
- ◆ 18.5 minutes after the first incident, an additional lightning strike caused the loss of two 345-kV lines, which connect Sprain Brook to Buchanan North and Sprain Brook to Millwood West. These two 345-kV lines share common towers between Millwood West and Sprain Brook. One line (Sprain Brook to Millwood West) automatically reclosed and was restored to service in about 2 seconds. The failure of the other line to reclose isolated the last Consolidated Edison interconnection to the Northwest.
- ◆ The resulting surge of power from the Northwest caused the loss of the Pleasant Valley to Millwood West line by relay action (a bent contact on one of the relays at Millwood West caused the improper action).
- ◆ 23 minutes later, the Leeds to Pleasant Valley 345-kV line sagged into a tree due to overload and tripped out.
- ◆ Within a minute, the 345 kV to 138 kV transformer at Pleasant Valley overloaded and tripped off, leaving Consolidated Edison with only three remaining interconnections.
- ◆ Within 3 minutes, the Long Island Lighting Co. system operator, on concurrence of the pool dispatcher, manually opened the Jamaica to Valley Stream tie.
- ◆ About 7 minutes later, the tap-changing mechanism failed on the Goethals phase-shifter, resulting in the loss of the Linden-to-Goethals tie to PJM, which was carrying 1,150 MW to Consolidated Edison.
- ◆ The two remaining external 138-kV ties to Consolidated Edison tripped on overload, isolating the Consolidated Edison system.
- ◆ Insufficient generation in the isolated system caused the Consolidated Edison island to collapse.

December 22, 1982: West Coast Blackout

This disturbance resulted in the loss of 12,350 MW of load and affected over 5 million people in the West. The outage began when high winds caused the failure of a 500-kV transmission tower. The tower fell into a parallel 500-kV line tower, and both lines were lost. The failure of these two lines mechanically cascaded and caused three additional towers to fail on each line. When the line conductors fell they contacted two 230-kV lines crossing under the 500-kV rights-of-way, collapsing the 230-kV lines.

The loss of the 500-kV lines activated a remedial action scheme to control the separation of the interconnection into two pre-engineered islands and trip generation in the Pacific Northwest in order to minimize customer outages and speed restoration. However, delayed operation of the remedial action scheme components occurred for several reasons, and the interconnection separated into four islands.

In addition to the mechanical failure of the transmission lines, analysis of this outage cited problems with coordination of protective schemes, because the generator tripping and separation schemes operated slowly or did not operate as planned. A communication channel component performed sporadically, resulting in delayed transmission of the control signal. The backup separation scheme also failed to operate, because the coordination of relay settings did not anticipate the power flows experienced in this severe disturbance.

In addition, the volume and format in which data were displayed to operators made it difficult to assess the extent of the disturbance and what corrective action should be taken. Time references to events in this disturbance were not tied to a common standard, making real-time evaluation of the situation more difficult.

July 2-3, 1996: West Coast Blackout

This disturbance resulted in the loss of 11,850 MW of load and affected 2 million people in the West. Customers were affected in Arizona, California, Colorado, Idaho, Montana, Nebraska, Nevada, New Mexico, Oregon, South Dakota, Texas, Utah, Washington, and Wyoming in the United States; Alberta and British Columbia in Canada; and Baja California Norte in Mexico. Outages lasted from a few minutes to several hours.

The outage began when a 345-kV transmission line in Idaho sagged into a tree and tripped out. A protective relay on a parallel transmission line also detected the fault and incorrectly tripped a second line. An almost simultaneous loss of these lines greatly reduced the ability of the system to transmit power from the nearby Jim Bridger plant. Other relays tripped two of the four generating units at that plant. With the loss of those two units, frequency in the entire Western Interconnection began to decline, and voltage began to collapse in the Boise, Idaho, area, affecting the California-Oregon AC Intertie transfer limit.

For 23 seconds the system remained in precarious balance, until the Mill Creek to Antelope 230-kV line between Montana and Idaho tripped by zone 3 relay, depressing voltage at Summer Lake Substation and causing the intertie to slip out of synchronism. Remedial action relays separated the system into five pre-engineered islands designed to minimize customer outages and restoration times. Similar conditions and initiating factors were present on July 3; however, as voltage began to collapse in the Boise area, the operator shed load manually and contained the disturbance.

August 10, 1996: West Coast Blackout

This disturbance resulted in the loss of over 28,000 MW of load and affected 7.5 million people in the West. Customers were affected in Arizona, California, Colorado, Idaho, Montana, Nebraska, Nevada, New Mexico, Oregon, South Dakota, Texas, Utah, Washington, and Wyoming in the United States; Alberta and British Columbia in Canada; and Baja California Norte in Mexico. Outages lasted from a few minutes to as long as nine hours.

Triggered by several major transmission line outages, the loss of generation from McNary Dam, and resulting system oscillations, the Western Interconnection separated into four electrical islands, with significant loss of load and generation. Prior to the disturbance, the transmission system from Canada south through the Northwest into California was heavily loaded with north-to-south power transfers. These flows were due to high Southwest demand caused by hot weather, combined with excellent hydroelectric conditions in Canada and the Northwest.

Very high temperatures in the Northwest caused two lightly loaded transmission lines to sag into untrimmed trees and trip out. A third heavily loaded line also sagged into a tree. Its outage led to

the overload and loss of additional transmission lines. General voltage decline in the Northwest and the loss of McNary generation due to incorrectly applied relays caused power oscillations on the California to Oregon AC intertie. The intertie's protective relays tripped these facilities out and caused the Western Interconnection to separate into four islands. Following the loss of the first two lightly loaded lines, operators were unaware that the system was in an insecure state over the next hour, because new operating studies had not been performed to identify needed system adjustments.

June 25, 1998: Upper Midwest Blackout

This disturbance resulted in the loss of 950 MW of load and affected 152,000 people in Minnesota, Montana, North Dakota, South Dakota, and Wisconsin in the United States; and Ontario, Manitoba, and Saskatchewan in Canada. Outages lasted up to 19 hours.

A lightning storm in Minnesota initiated a series of events, causing a system disturbance that affected the entire Mid-Continent Area Power Pool (MAPP) Region and the northwestern Ontario Hydro system of the Northeast Power Coordinating Council. A 345-kV line was struck by lightning and tripped out. Underlying lower voltage lines began to overload and trip out, further weakening the system. Soon afterward, lightning struck a second 345-kV line, taking it out of service as well. Following the outage of the second 345-kV line, the remaining lower voltage transmission lines in the area became significantly overloaded, and relays took them out of service. This cascading removal of lines from service continued until the entire northern MAPP Region was separated from the Eastern Interconnection, forming three islands and resulting in the eventual blackout of the northwestern Ontario Hydro system.

Summer of 1999: Northeast U.S. Non-outage Disturbances

Load in the PJM system on July 6, 1999, was 51,600 MW (approximately 5,000 MW above forecast). PJM used all emergency procedures (including a 5% voltage reduction) except manually tripping load, and imported 5,000 MW from external systems to serve the record customer demand. Load on July 19, 1999, exceeded 50,500 MW. PJM loaded all available eastern PJM generation and again implemented emergency operating procedures from approximately 12 noon into the evening on both days.

During these record peak loads, steep voltage declines were experienced on the bulk transmission system. In each case, a voltage collapse was barely averted through the use of emergency procedures. Low voltage occurred because reactive demand exceeded reactive supply. High reactive demand was due to high electricity demand and high losses resulting from high transfers across the system. Reactive supply was inadequate because generators were unavailable or unable to meet rated reactive capability due to ambient conditions, and because some shunt capacitors were out of service.

Common or Similar Factors Among Major Outages

The factors that were common to some of the major outages above and the August 14 blackout include: (1) conductor contact with trees; (2) over-estimation of dynamic reactive output of system generators; (3) inability of system operators or coordinators to visualize events on the entire system; (4) failure to ensure that system operation was within safe limits; (5) lack of coordination on system protection; (6) ineffective communication; (7) lack of “safety nets;” and (8) inadequate training of operating personnel. The following sections describe the nature of these factors and list recommendations from previous investigations that are relevant to each.

Conductor Contact With Trees

This factor was an initiating trigger in several of the outages and a contributing factor in the severity of several more. Unlike lightning strikes, for which system operators have fair storm-tracking tools, system operators generally do not have direct knowledge that a line has contacted a tree and faulted. They will sometimes test the line by trying to restore it to service, if that is deemed to be a safe operation. Even if it does go back into service, the line may fault and trip out again as load heats it up. This is most likely to happen when vegetation has not been adequately managed, in combination with hot and windless conditions.

In some of the disturbances, tree contact accounted for the loss of more than one circuit, contributing multiple contingencies to the weakening of the system. Lines usually sag into right-of-way obstructions when the need to retain transmission interconnection is high. High inductive load composition, such as air conditioning or irrigation

pumping, accompanies hot weather and places higher burdens on transmission lines. Losing circuits contributes to voltage decline. Inductive load is unforgiving when voltage declines, drawing additional reactive supply from the system and further contributing to voltage problems.

Recommendations from previous investigations include:

- ◆ Paying special attention to the condition of rights-of-way following favorable growing seasons. Very wet and warm spring and summer growing conditions preceded the 1996 outages in the West.
- ◆ Careful review of any reduction in operations and maintenance expenses that may contribute to decreased frequency of line patrols or trimming. Maintenance in this area should be strongly directed toward preventive rather than remedial maintenance.

Dynamic Reactive Output of Generators

Reactive supply is an important ingredient in maintaining healthy power system voltages and facilitating power transfers. Inadequate reactive supply was a factor in most of the events. Shunt capacitors and generating resources are the most significant suppliers of reactive power. Operators perform contingency analysis based on how power system elements will perform under various power system conditions. They determine and set transfer limits based on these analyses. Shunt capacitors are easy to model because they are static. Modeling the dynamic reactive output of generators under stressed system conditions has proven to be more challenging. If the model is incorrect, estimated transfer limits will also be incorrect.

In most of the events, the assumed contribution of dynamic reactive output of system generators was greater than the generators actually produced, resulting in more significant voltage problems. Some generators were limited in the amount of reactive power they produced by over-excitation limits, or necessarily derated because of high ambient temperatures. Other generators were controlled to a fixed power factor and did not contribute reactive supply in depressed voltage conditions. Under-voltage load shedding is employed as an automatic remedial action in some interconnections to prevent cascading, and could be used more widely.

Recommendations from previous investigations concerning voltage support and reactive power management include:

- ◆ Communicate changes to generator reactive capability limits in a timely and accurate manner for both planning and operational modeling purposes.
- ◆ Investigate the development of a generator MVar/voltage monitoring process to determine when generators may not be following reported MVar limits.
- ◆ Establish a common standard for generator steady-state and post-contingency (15-minute) MVar capability definition; determine methodology, testing, and operational reporting requirements.
- ◆ Determine the generator service level agreement that defines generator MVar obligation to help ensure reliable operations.
- ◆ Periodically review and field test the reactive limits of generators to ensure that reported MVar limits are attainable.
- ◆ Provide operators with on-line indications of available reactive capability from each generating unit or groups of generators, other VAR sources, and the reactive margin at all critical buses. This information should assist in the operating practice of maximizing the use of shunt capacitors during heavy transfers and thereby increase the availability of system dynamic reactive reserve.
- ◆ For voltage instability problems, consider fast automatic capacitor insertion (both series and shunt), direct shunt reactor and load tripping, and under-voltage load shedding.
- ◆ Develop and periodically review a reactive margin against which system performance should be evaluated and used to establish maximum transfer levels.

System Visibility Procedures and Operator Tools

Each control area operates as part of a single synchronous interconnection. However, the parties with various geographic or functional responsibilities for reliable operation of the grid do not have visibility of the entire system. Events in neighboring systems may not be visible to an operator or reliability coordinator, or power system data may be available in a control center but not be

presented to operators or coordinators as information they can use in making appropriate operating decisions.

Recommendations from previous investigations concerning visibility and tools include:

- ◆ Develop communications systems and displays that give operators immediate information on changes in the status of major components in their own and neighboring systems.
- ◆ Supply communications systems with uninterrupted power, so that information on system conditions can be transmitted correctly to control centers during system disturbances.
- ◆ In the control center, use a dynamic line loading and outage display board to provide operating personnel with rapid and comprehensive information about the facilities available and the operating condition of each facility in service.
- ◆ Give control centers the capability to display to system operators computer-generated alternative actions specific to the immediate situation, together with expected results of each action.
- ◆ Establish on-line security analysis capability to identify those next and multiple facility outages that would be critical to system reliability from thermal, stability, and post-contingency voltage points of view.
- ◆ Establish time-synchronized disturbance monitoring to help evaluate the performance of the interconnected system under stress, and design appropriate controls to protect it.

System Operation Within Safe Limits

Operators in several of the events were unaware of the vulnerability of the system to the next contingency. The reasons were varied: inaccurate modeling for simulation, no visibility of the loss of key transmission elements, no operator monitoring of stability measures (reactive reserve monitor, power transfer angle), and no reassessment of system conditions following the loss of an element and readjustment of safe limits.

Recommendations from previous investigations include:

- ◆ Following a contingency, the system must be returned to a reliable state within the allowed readjustment period. Operating guides must be reviewed to ensure that procedures exist to restore system reliability in the allowable time periods.

- ◆ Reduce scheduled transfers to a safe and prudent level until studies have been conducted to determine the maximum simultaneous transfer capability limits.
- ◆ Reevaluate processes for identifying unusual operating conditions and potential disturbance scenarios, and make sure they are studied before they are encountered in real-time operating conditions.

Coordination of System Protection (Transmission and Generation Elements)

Protective relays are designed to detect short circuits and act locally to isolate faulted power system equipment from the system—both to protect the equipment from damage and to protect the system from faulty equipment. Relay systems are applied with redundancy in primary and backup modes. If one relay fails, another should detect the fault and trip appropriate circuit breakers. Some backup relays have significant “reach,” such that non-faulted line overloads or stable swings may be seen as faults and cause the tripping of a line when it is not advantageous to do so. Proper coordination of the many relay devices in an interconnected system is a significant challenge, requiring continual review and revision. Some relays can prevent resynchronizing, making restoration more difficult.

System-wide controls protect the interconnected operation rather than specific pieces of equipment. Examples include controlled islanding to mitigate the severity of an inevitable disturbance and under-voltage or under-frequency load shedding. Failure to operate (or misoperation of) one or more relays as an event developed was a common factor in several of the disturbances.

Recommendations developed after previous outages include:

- ◆ Perform system trip tests of relay schemes periodically. At installation the acceptance test should be performed on the complete relay scheme in addition to each individual component so that the adequacy of the scheme is verified.
- ◆ Continually update relay protection to fit changing system development and to incorporate improved relay control devices.
- ◆ Install sensing devices on critical transmission lines to shed load or generation automatically if the short-term emergency rating is exceeded for

a specified period of time. The time delay should be long enough to allow the system operator to attempt to reduce line loadings promptly by other means.

- ◆ Review phase-angle restrictions that can prevent reclosing of major interconnections during system emergencies. Consideration should be given to bypassing synchronism-check relays to permit direct closing of critical interconnections when it is necessary to maintain stability of the grid during an emergency.
- ◆ Review the need for controlled islanding. Operating guides should address the potential for significant generation/load imbalance within the islands.

Effectiveness of Communications

Under normal conditions, parties with reliability responsibility need to communicate important and prioritized information to each other in a timely way, to help preserve the integrity of the grid. This is especially important in emergencies. During emergencies, operators should be relieved of duties unrelated to preserving the grid. A common factor in several of the events described above was that information about outages occurring in one system was not provided to neighboring systems.

Need for Safety Nets

A safety net is a protective scheme that activates automatically if a pre-specified, significant contingency occurs. When activated, such schemes involve certain costs and inconvenience, but they can prevent some disturbances from getting out of control. These plans involve actions such as shedding load, dropping generation, or islanding, and in all cases the intent is to have a controlled outcome that is less severe than the likely uncontrolled outcome. If a safety net had not been taken out of service in the West in August 1996, it would have lessened the severity of the disturbance from 28,000 MW of load lost to less than 7,200 MW. (It has since been returned to service.) Safety nets should not be relied upon to establish transfer limits, however.

Previous recommendations concerning safety nets include:

- ◆ Establish and maintain coordinated programs of automatic load shedding in areas not so equipped, in order to prevent total loss of power in an area that has been separated from the

main network and is deficient in generation. Load shedding should be regarded as an insurance program, however, and should not be used as a substitute for adequate system design.

- ◆ Install load-shedding controls to allow fast single-action activation of large-block load shedding by an operator.

Training of Operating Personnel

Operating procedures were necessary but not sufficient to deal with severe power system disturbances in several of the events. Enhanced procedures and training for operating personnel were recommended. Dispatcher training facility scenarios with disturbance simulation were suggested as well. Operators tended to reduce schedules for transactions but were reluctant to call for increased generation—or especially to shed load—in the face of a disturbance that threatened to bring the whole system down.

Previous recommendations concerning training include:

- ◆ Thorough programs and schedules for operator training and retraining should be vigorously administered.
- ◆ A full-scale simulator should be made available to provide operating personnel with “hands-on” experience in dealing with possible emergency or other system conditions.
- ◆ Procedures and training programs for system operators should include anticipation, recognition, and definition of emergency situations.
- ◆ Written procedures and training materials should include criteria that system operators can use to recognize signs of system stress and mitigating measures to be taken before conditions degrade into emergencies.
- ◆ Line loading relief procedures should not be relied upon when the system is in an insecure state, as these procedures cannot be implemented effectively within the required time

frames in many cases. Other readjustments must be used, and the system operator must take responsibility to restore the system immediately.

- ◆ Operators’ authority and responsibility to take immediate action if they sense the system is starting to degrade should be emphasized and protected.
- ◆ The current processes for assessing the potential for voltage instability and the need to enhance the existing operator training programs, operational tools, and annual technical assessments should be reviewed to improve the ability to predict future voltage stability problems prior to their occurrence, and to mitigate the potential for adverse effects on a regional scale.

Comparisons With the August 14 Blackout

The blackout on August 14, 2003, had several causes or contributory factors in common with the earlier outages, including:

- ◆ Inadequate vegetation management
- ◆ Failure to ensure operation within secure limits
- ◆ Failure to identify emergency conditions and communicate that status to neighboring systems
- ◆ Inadequate operator training
- ◆ Inadequate regional-scale visibility over the power system
- ◆ Inadequate coordination of relays and other protective devices or systems.

New causal features of the August 14 blackout include: inadequate interregional visibility over the power system; dysfunction of a control area’s SCADA/EMS system; and lack of adequate backup capability to that system.

8. Performance of Nuclear Power Plants Affected by the Blackout

Introduction

On August 14, 2003, nine U.S. nuclear power plants experienced rapid shutdowns (reactor trips) as a consequence of the power outage. Seven nuclear power plants in Canada operating at high power levels at the time of the event also experienced rapid shutdowns. Four other Canadian nuclear plants automatically disconnected from the grid due to the electrical transient but were able to continue operating at a reduced power level and were available to supply power to the grid as it was restored by the transmission system operators. Six nuclear plants in the United States and one in Canada experienced significant electrical disturbances but were able to continue generating electricity. Many non-nuclear generating plants in both countries also tripped during the event. Numerous other nuclear plants observed disturbances on the electrical grid but continued to generate electrical power without interruption.

The Nuclear Working Group (NWG) was one of three Working Groups created to support the U.S.-Canada Power System Outage Task Force. The NWG was charged with identifying all relevant actions by nuclear generating facilities in connection with the outage. Nils Diaz, Chairman of the U.S. Nuclear Regulatory Commission (NRC) and Linda Keen, President and CEO of the Canadian Nuclear Safety Commission (CNSC) were co-chairs of the Working Group, with other members appointed from industry and various State and federal agencies.

In Phase I, the NWG focused on collecting and analyzing data from each affected nuclear power plant to determine what happened, and whether any activities at the plants caused or contributed to the power outage or involved a significant safety issue. Phase I culminated in the issuance of the Task Force's *Interim Report*, which reported that:

- ◆ The affected nuclear power plants did not trigger the power outage or inappropriately

contribute to its spread (i.e., to an extent beyond the normal tripping of the plants at expected conditions).

- ◆ The severity of the grid transient caused generators, turbines, or reactor systems at the nuclear plants to reach protective feature limits and actuate automatic protective actions.
- ◆ The nuclear plants responded to the grid conditions in a manner consistent with the plant designs.
- ◆ The nuclear plants were maintained in a safe condition until conditions were met to permit the nuclear plants to resume supplying electrical power to the grid.

◆ For nuclear plants in the United States:

- Fermi 2, Oyster Creek, and Perry tripped due to main generator trips, which resulted from voltage and frequency fluctuations on the grid. Nine Mile 1 tripped due to a main turbine trip due to frequency fluctuations on the grid.
- FitzPatrick and Nine Mile 2 tripped due to reactor trips, which resulted from turbine control system low pressure due to frequency fluctuations on the grid. Ginna tripped due to a reactor trip which resulted from a large loss of electrical load due to frequency fluctuations on the grid. Indian Point 2 and Indian Point 3 tripped due to a reactor trip on low flow, which resulted when low grid frequency tripped reactor coolant pumps.

◆ For nuclear plants in Canada:

- At Bruce B and Pickering B, frequency and/or voltage fluctuations on the grid resulted in the automatic disconnection of generators from the grid. For those units that were successful in maintaining the unit generators operational, reactor power was automatically reduced.

- At Darlington, load swing on the grid led to the automatic reduction in power of the four reactors. The generators were, in turn, automatically disconnected from the grid.
- Three reactors at Bruce B and one at Darlington were returned to 60% power. These reactors were available to deliver power to the grid on the instructions of the transmission system operator.
- Three units at Darlington were placed in a zero-power hot state, and four units at Pickering B and one unit at Bruce B were placed in a Guaranteed Shutdown State.

The licensees' return to power operation followed a deliberate process controlled by plant procedures and regulations. Equipment and process problems, whether existing prior to or caused by the event, would normally be addressed prior to restart. The NWG is satisfied that licensees took an appropriately conservative approach to their restart activities, placing a priority on safety.

◆ **For U.S. nuclear plants:** Ginna, Indian Point 2, Nine Mile 2, and Oyster Creek resumed electrical generation on August 17. FitzPatrick and Nine Mile 1 resumed electrical generation on August 18. Fermi 2 resumed electrical generation on August 20. Perry resumed electrical generation on August 21. Indian Point 3 resumed electrical generation on August 22. Indian Point 3 had equipment issues (failed splices in the control rod drive mechanism power system) that required repair prior to restart. Ginna submitted a special request for enforcement discretion from the NRC to permit mode changes and restart with an inoperable auxiliary feedwater pump. The NRC granted the request for enforcement discretion.

◆ **For Canadian nuclear plants:** The restart of the Canadian nuclear plants was carried out in accordance with approved Operating Policies and Principles. Three units at Bruce B and one at Darlington were resynchronized with the grid within 6 hours of the event. The remaining three units at Darlington were reconnected by August 17 and 18. Units 5, 6, and 8 at Pickering B and Unit 6 at Bruce B returned to service between August 22 and August 25.

The NWG has found no evidence that the shutdown of the nuclear power plants triggered the outage or inappropriately contributed to its spread (i.e., to an extent beyond the normal tripping of the plants at expected conditions). All the nuclear

plants that shut down or disconnected from the grid responded automatically to grid conditions. All the nuclear plants responded in a manner consistent with the plant designs. Safety functions were effectively accomplished, and the nuclear plants that tripped were maintained in a safe shutdown condition until their restart.

In Phase II, the NWG collected comments and analyzed information related to potential recommendations to help prevent future power outages. Representatives of the NWG, including representatives of the NRC and the CNSC, attended public meetings to solicit feedback and recommendations held in Cleveland, Ohio; New York City, New York; and Toronto, Ontario, on December 4, 5, and 8, 2003, respectively. Representatives of the NWG also participated in the NRC's public meeting to solicit feedback and recommendations on the Northeast blackout held in Rockville, Maryland, on January 6, 2004.

Additional details on both the Phase I and Phase II efforts are available in the following sections. Due to the major design differences between nuclear plants in Canada and the United States, the NWG decided to have separate sections for each country. This also responds to the request by the nuclear regulatory agencies in both countries to have sections of the report that stand alone, so that they can also be used as regulatory documents.

Findings of the U.S. Nuclear Working Group

Summary

The U.S. NWG found no evidence that the shutdown of the nine U.S. nuclear power plants triggered the outage, or inappropriately contributed to its spread (i.e., to an extent beyond the normal tripping of the plants at expected conditions). All nine plants that experienced a reactor trip were responding to grid conditions. The severity of the grid transient caused generators, turbines, or reactor systems at the plants to reach a protective feature limit and actuate a plant shutdown. All nine plants tripped in response to those conditions in a manner consistent with the plant designs. The nine plants automatically shut down in a safe fashion to protect the plants from the grid transient. Safety functions were effectively accomplished with few problems, and the plants were maintained in a safe shutdown condition until their restart.

The nuclear power plant outages that resulted from the August 14, 2003, power outage were triggered by automatic protection systems for the reactors or turbine-generators, not by any manual operator actions. The NWG has received no information that points to operators deliberately shutting down nuclear units to isolate themselves from instabilities on the grid. In short, only automatic separation of nuclear units occurred.

Regarding the 95 other licensed commercial nuclear power plants in the United States: 4 were already shut down at the time of the power outage, one of which experienced a grid disturbance; 70 operating plants observed some level of grid disturbance but accommodated the disturbances and remained on line, supplying power to the grid; and 21 operating plants did not experience any grid disturbance.

Introduction

The NRC, which regulates U.S. commercial nuclear power plants, has regulatory requirements for offsite power systems. These requirements address the number of offsite power sources and the ability to withstand certain transients. Offsite power is the normal source of alternating current (AC) power to the safety systems in the plants when the plant main generator is not in operation. The requirements also are designed to protect safety systems from potentially damaging variations (in voltage and frequency) in the supplied power. For loss of offsite power events, the NRC requires emergency generation (typically emergency diesel generators) to provide AC power to safety systems. In addition, the NRC provides oversight of the safety aspects of offsite power issues through its inspection program, by monitoring operating experience, and by performing technical studies.

Phase I: Fact Finding

Phase I of the NWG effort focused on collecting and analyzing data from each plant to determine what happened, and whether any activities at the plants caused or contributed to the power outage or its spread or involved a significant safety issue. To ensure accuracy, comprehensive coordination was maintained among the working group members and among the NWG, ESWG, and SWG.

The staff developed a set of technical questions to obtain data from the owners or licensees of the nuclear power plants that would enable them to review the response of the nuclear plant systems

in detail. Two additional requests for more specific information were made for certain plants. The collection of information from U.S. nuclear power plants was gathered through the NRC regional offices, which had NRC resident inspectors at each plant obtain licensee information to answer the questions. General design information was gathered from plant-specific Updated Final Safety Analysis Reports and other documents.

Plant data were compared against plant designs by the NRC staff to determine whether the plant responses were as expected; whether they appeared to cause the power outage or contributed to the spread of the outage; and whether applicable safety requirements were met. In some cases supplemental questions were developed, and answers were obtained from the licensees to clarify the observed response of the plant. The NWG interfaced with the ESWG to validate some data and to obtain grid information, which contributed to the analysis. The NWG identified relevant actions by nuclear generating facilities in connection with the power outage.

Typical Design, Operational, and Protective Features of U.S. Nuclear Power Plants

Nuclear power plants have a number of design, operational, and protective features to ensure that the plants operate safely and reliably. This section describes these features so as to provide a better understanding of how nuclear power plants interact with the grid and, specifically, how nuclear power plants respond to changing grid conditions. While the features described in this section are typical, there are differences in the design and operation of individual plants which are not discussed.

Design Features of U.S. Nuclear Power Plants

Nuclear power plants use heat from nuclear reactions to generate steam and use a single steam-driven turbine-generator (also known as the main generator) to produce electricity supplied to the grid.

Connection of the plant switchyard to the grid. The plant switchyard normally forms the interface between the plant main generator and the electrical grid. The plant switchyard has multiple transmission lines connected to the grid system to meet offsite power supply requirements for having reliable offsite power for the nuclear station under all operating and shutdown conditions. Each

transmission line connected to the switchyard has dedicated circuit breakers, with fault sensors, to isolate faulted conditions in the switchyard or the connected transmission lines, such as phase-to-phase or phase-to-ground short circuits. The fault sensors are fed into a protection scheme for the plant switchyard that is engineered to localize any faulted conditions with minimum system disturbance.

Connection of the main generator to the switchyard. The plant main generator produces electrical power and transmits that power to the offsite transmission system. Most plants also supply power to the plant auxiliary buses for normal operation of the nuclear generating unit through the unit auxiliary transformer. During normal plant operation, the main generator typically generates electrical power at about 22 kV. The voltage is increased to match the switchyard voltage by the main transformers, and the power flows to the high voltage switchyard through two power circuit breakers.

Power supplies for the plant auxiliary buses. The safety-related and nonsafety auxiliary buses are normally lined up to receive power from the main generator auxiliary transformer, although some plants leave some of their auxiliary buses powered from a startup transformer (that is, from the offsite power distribution system). When plant power generation is interrupted, the power supply automatically transfers to the offsite power source (the startup transformer). If that is not supplying acceptable voltage, the circuit breakers to the safety-related buses open, and the buses are reenergized by the respective fast-starting emergency diesel generators. The nonsafety auxiliary buses will remain deenergized until offsite power is restored.

Operational Features of U.S. Nuclear Power Plants

Response of nuclear power plants to changes in switchyard voltage. With the main generator voltage regulator in the automatic mode, the generator will respond to an increase of switchyard voltage by reducing the generator field excitation current. This will result in a decrease of reactive power, normally measured as mega-volts-amperes-reactive (MVAR) from the generator to the switchyard and out to the surrounding grid, helping to control the grid voltage increase. With the main generator voltage regulator in the automatic mode, the generator will respond to a decrease of switchyard voltage by increasing the generator field excitation current. This will result in an increase of reactive

power (MVAR) from the generator to the switchyard and out to the surrounding grid, helping to control the grid voltage decrease. If the switchyard voltage goes low enough, the increased generator field current could result in generator field overheating. Over-excitation protective circuitry is generally employed to prevent this from occurring. This protective circuitry may trip the generator to prevent equipment damage.

Under-voltage protection is provided for the nuclear power plant safety buses, and may be provided on nonsafety buses and at individual pieces of equipment. It is also used in some pressurized water reactor designs on reactor coolant pumps (RCPs) as an anticipatory loss of RCP flow signal.

Protective Features of U.S. Nuclear Power Plants

The main generator and main turbine have protective features, similar to fossil generating stations, which protect against equipment damage. In general, the reactor protective features are designed to protect the reactor fuel from damage and to protect the reactor coolant system from over-pressure or over-temperature transients. Some trip features also produce a corresponding trip in other components; for example, a turbine trip typically results in a reactor trip above a low power setpoint.

Generator protective features typically include over-current, ground detection, differential relays (which monitor for electrical fault conditions within a zone of protection defined by the location of the sensors, typically the main generator and all transformers connected directly to the generator output), electrical faults on the transformers connected to the generator, loss of the generator field, and a turbine trip. Turbine protective features typically include over-speed (usually set at 1980 rpm or 66 Hz), low bearing oil pressure, high bearing vibration, degraded condenser vacuum, thrust bearing failure, or generator trip. Reactor protective features typically include trips for over-power, abnormal pressure in the reactor coolant system, low reactor coolant system flow, low level in the steam generators or the reactor vessel, or a trip of the turbine.

Considerations on Returning a U.S. Nuclear Power Plant to Power Production After Switchyard Voltage Is Restored

The following are examples of the types of activities that must be completed before returning a

nuclear power plant to power production following a loss of switchyard voltage.

- ◆ Switchyard voltage must be normal and stable from an offsite supply. Nuclear power plants are not designed for black-start capability (the ability to start up without external power).
- ◆ Plant buses must be energized from the switchyard and the emergency diesel generators restored to standby mode.
- ◆ Normal plant equipment, such as reactor coolant pumps and circulating water pumps, must be restarted.
- ◆ A reactor trip review report must be completed and approved by plant management, and the cause of the trip must be addressed.
- ◆ All plant technical specifications must be satisfied. Technical specifications are issued to each nuclear power plant as part of their license by the NRC. They dictate equipment which must be operable and process parameters which must be met to allow operation of the reactor. Examples of actions that were required following the events of August 14 include refilling the diesel fuel oil storage tanks, refilling the condensate storage tanks, establishing reactor coolant system forced flow, and cooling the suppression pool to normal operating limits. Surveillance tests must be completed as required by technical specifications (for example, operability of the low-range neutron detectors must be demonstrated).
- ◆ Systems must be aligned to support the startup.
- ◆ Pressures and temperatures for reactor startup must be established in the reactor coolant system for pressurized water reactors.
- ◆ A reactor criticality calculation must be performed to predict the control rod withdrawals needed to achieve criticality, where the fission chain reaction becomes self-sustaining due to the increased neutron flux. Certain neutron-absorbing fission products increase in concentration following a reactor trip (followed later by a decrease or decay). At pressurized water reactors, the boron concentration in the primary coolant must be adjusted to match the criticality calculation. Near the end of the fuel cycle, the nuclear power plant may not have enough boron adjustment or control rod worth available for restart until the neutron absorbers have

decreased significantly (more than 24 hours after the trip).

It may require a day or more before a nuclear power plant can restart following a normal trip. Plant trips are a significant transient on plant equipment, and some maintenance may be necessary before the plant can restart. When combined with the infrequent event of loss of offsite power, additional recovery actions will be required. Safety systems, such as emergency diesel generators and safety-related decay heat removal systems, must be restored to normal lineups. These additional actions would extend the time necessary to restart a nuclear plant from this type of event.

Summary of U.S. Nuclear Power Plant Response to and Safety During the August 14 Outage

The NWG's review did not identify any activity or equipment issues at U.S. nuclear power plants that caused the transient on August 14, 2003. Nine nuclear power plants tripped within about 60 seconds as a result of the grid disturbance. Additionally, many nuclear power plants experienced a transient due to this grid disturbance.

Nuclear Power Plants That Tripped

The trips at nine nuclear power plants resulted from the plant responses to the grid disturbances. Following the initial grid disturbances, voltages in the plant switchyard fluctuated and reactive power flows fluctuated. As the voltage regulators on the main generators attempted to compensate, equipment limits were exceeded and protective trips resulted. This happened at Fermi 2 and Oyster Creek. Fermi 2 tripped on a generator field protection trip. Oyster Creek tripped due to a generator trip on high ratio of voltage relative to the electrical frequency.

Also, as the balance between electrical generation and electrical load on the grid was disturbed, the electrical frequency began to fluctuate. In some cases the electrical frequency dropped low enough to actuate protective features. This happened at Indian Point 2, Indian Point 3, and Perry. Perry tripped due to a generator under-frequency trip signal. Indian Point 2 and Indian Point 3 tripped when the grid frequency dropped low enough to trip reactor coolant pumps, which actuated a reactor protective feature.

In other cases, the electrical frequency fluctuated and went higher than normal. Turbine control systems responded in an attempt to control the frequency. Equipment limits were exceeded as a result of the reaction of the turbine control systems to large frequency changes. This led to trips at FitzPatrick, Nine Mile 1, Nine Mile 2, and Ginna. FitzPatrick and Nine Mile 2 tripped on low pressure in the turbine hydraulic control oil system. Nine Mile 1 tripped on turbine light load protection. Ginna tripped due to conditions in the reactor following rapid closure of the turbine control valves in response to high frequency on the grid.

The Perry, Fermi 2, Oyster Creek, and Nine Mile 1 reactors tripped immediately after the generator tripped, although that is not apparent from the times below, because the clocks were not synchronized to the national time standard. The Indian Point 2 and 3, FitzPatrick, Ginna, and Nine Mile 2 reactors tripped before the generators. When the reactor trips first, there is generally a short time delay before the generator output breakers open. The electrical generation decreases rapidly to zero after the reactor trip. Table 8.1 provides the times from the data collected for the reactor trip times, and the time the generator output breakers opened (generator trip), as reported by the ESWG. Additional details on the plants that tripped are given below, and summarized in Table 8.2 on page 120.

Fermi 2. Fermi 2 is located 25 miles (40 km) northeast of Toledo, Ohio, in southern Michigan on Lake Erie. It was generating about 1,130 megawatts-electric (MWe) before the event. The reactor tripped due to a turbine trip. The turbine trip was likely the result of multiple generator field protection trips (overexcitation and loss of field) as the Fermi 2 generator responded to a series of rapidly changing transients prior to its loss. This is consistent with data that shows large swings of the Fermi 2 generator MVAR prior to its trip.

Offsite power was subsequently lost to the plant auxiliary buses. The safety buses were deenergized and automatically reenergized from the emergency diesel generators. The operators tripped one emergency diesel generator that was paralleled to the grid for testing, after which it automatically loaded. Decay heat removal systems maintained the cooling function for the reactor fuel.

The lowest emergency declaration, an Unusual Event, was declared at about 16:22 EDT due to the loss of offsite power. Offsite power was restored to

at least one safety bus at about 01:53 EDT on August 15. The following equipment problems were noted: the Combustion Turbine Generator (the alternate AC power source) failed to start from the control room; however, it was successfully started locally. In addition, the Spent Fuel Pool Cooling System was interrupted for approximately 26 hours and reached a maximum temperature of 130 degrees Fahrenheit (55 degrees Celsius). The main generator was reconnected to the grid at about 01:41 EDT on August 20.

FitzPatrick. FitzPatrick is located about 8 miles (13 km) northeast of Oswego, NY, in northern New York on Lake Ontario. It was generating about 850 MWe before the event. The reactor tripped due to low pressure in the hydraulic system that controls the turbine control valves. Low pressure in this system typically indicates a large load reject, for which a reactor trip is expected. In this case the pressure in the system was low because the control system was rapidly manipulating the turbine control valves to control turbine speed, which was being affected by grid frequency fluctuations.

Immediately preceding the trip, both significant over-voltage and under-voltage grid conditions were experienced. Offsite power was subsequently lost to the plant auxiliary buses. The safety buses were deenergized and automatically reenergized from the emergency diesel generators.

The lowest emergency declaration, an Unusual Event, was declared at about 16:26 EDT due to the loss of offsite power. Decay heat removal systems maintained the cooling function for the reactor fuel. Offsite power was restored to at least one safety bus at about 23:07 EDT on August 14. The main generator was reconnected to the grid at about 06:10 EDT on August 18.

Table 8.1. U.S. Nuclear Plant Trip Times

Nuclear Plant	Reactor Trip ^a	Generator Trip ^b
Perry	16:10:25 EDT	16:10:42 EDT
Fermi 2	16:10:53 EDT	16:10:53 EDT
Oyster Creek . . .	16:10:58 EDT	16:10:57 EDT
Nine Mile 1	16:11 EDT	16:11:04 EDT
Indian Point 2 . .	16:11 EDT	16:11:09 EDT
Indian Point 3 . .	16:11 EDT	16:11:23 EDT
FitzPatrick	16:11:04 EDT	16:11:32 EDT
Ginna	16:11:36 EDT	16:12:17 EDT
Nine Mile 2	16:11:48 EDT	16:11:52 EDT

^aAs determined from licensee data (which may not be synchronized to the national time standard).

^bAs reported by the Electrical System Working Group (synchronized to the national time standard).

GINNA. Ginna is located 20 miles (32 km) northeast of Rochester, NY, in northern New York on Lake Ontario. It was generating about 487 MWe before the event. The reactor tripped due to Over-Temperature-Delta-Temperature. This trip signal protects the reactor core from exceeding temperature limits. The turbine control valves closed down in response to the changing grid conditions. This caused a temperature and pressure transient in the reactor, resulting in an Over-Temperature-Delta-Temperature trip.

Offsite power was not lost to the plant auxiliary buses. In the operators' judgement, offsite power was not stable, so they conservatively energized the safety buses from the emergency diesel generators. Decay heat removal systems maintained the cooling function for the reactor fuel. Offsite power was not lost, and stabilized about 50 minutes after the reactor trip.

The lowest emergency declaration, an Unusual Event, was declared at about 16:46 EDT due to the degraded offsite power. Offsite power was restored to at least one safety bus at about 21:08 EDT on August 14. The following equipment problems were noted: the digital feedwater control system behaved in an unexpected manner following the trip, resulting in high steam generator levels; there was a loss of RCP seal flow indication, which complicated restarting the pumps; and at least one of the power-operated relief valves experienced minor leakage following proper operation and closure during the transient. Also, one of the motor-driven auxiliary feedwater pumps was damaged after running with low flow conditions due to an improper valve alignment. The redundant pumps supplied the required water flow.

The NRC issued a Notice of Enforcement Discretion to allow Ginna to perform mode changes and restart the reactor with one auxiliary feedwater (AFW) pump inoperable. Ginna has two AFW pumps, one turbine-driven AFW pump, and two standby AFW pumps, all powered from safety-related buses. The main generator was reconnected to the grid at about 20:38 EDT on August 17.

Indian Point 2. Indian Point 2 is located 24 miles (39 km) north of New York City on the Hudson River. It was generating about 990 MWe before the event. The reactor tripped due to loss of a reactor coolant pump that tripped because the auxiliary bus frequency fluctuations actuated the under-frequency relay, which protects against inadequate coolant flow through the reactor core. This

reactor protection signal tripped the reactor, which resulted in turbine and generator trips.

The auxiliary bus experienced the under-frequency due to fluctuating grid conditions. Offsite power was lost to all the plant auxiliary buses. The safety buses were reenergized from the emergency diesel generators. Decay heat removal systems maintained the cooling function for the reactor fuel.

The lowest emergency declaration, an Unusual Event, was declared at about 16:25 EDT due to the loss of offsite power for more than 15 minutes. Offsite power was restored to at least one safety bus at about 20:02 EDT on August 14. The following equipment problems were noted: the service water to one of the emergency diesel generators developed a leak; a steam generator atmospheric dump valve did not control steam generator pressure in automatic and had to be shifted to manual; a steam trap associated with the turbine-driven AFW pump failed open, resulting in operators securing the turbine after 2.5 hours; loss of instrument air required operators to take manual control of charging and a letdown isolation occurred; and operators in the field could not use radios; and the diesel generator for the Unit 2 Technical Support Center failed to function. Also, several uninterruptible power supplies in the Emergency Operations Facility failed. This reduced the capability for communications and data collection. Alternate equipment was used to maintain vital communications.¹ The main generator was reconnected to the grid at about 12:58 EDT on August 17.

Indian Point 3. Indian Point 3 is located 24 miles (39 km) north of New York City on the Hudson River. It was generating about 1,010 MWe before the event. The reactor tripped due to loss of a reactor coolant pump that tripped because the auxiliary bus frequency fluctuations actuated the under-frequency relay, which protects against inadequate coolant flow through the reactor core. This reactor protection signal tripped the reactor, which resulted in turbine and generator trips.

The auxiliary bus experienced the under-frequency due to fluctuating grid conditions. Offsite power was lost to all the plant auxiliary buses. The safety buses were reenergized from the emergency diesel generators. Decay heat removal systems maintained the cooling function for the reactor fuel.

The lowest emergency declaration, an Unusual Event, was declared at about 16:23 EDT due to the

loss of offsite power for more than 15 minutes. Offsite power was restored to at least one safety bus at about 20:12 EDT on August 14. The following equipment problems were noted: a steam generator safety valve lifted below its desired setpoint and was gagged; loss of instrument air, including failure of the diesel backup compressor to start and failure of the backup nitrogen system, resulted in manual control of atmospheric dump valves and AFW pumps needing to be secured to prevent overfeeding the steam generators; a blown fuse in a battery charger resulted in a longer battery discharge; a control rod drive mechanism cable splice failed, and there were high resistance readings on 345-kV breaker-1. These equipment problems required correction prior to startup, which delayed the startup. The diesel generator for the Unit 3 Technical Support Center failed to function. Also, several uninterruptible power supplies in the Emergency Operations Facility failed. This reduced the capability for communications and data collection. Alternate equipment was used to maintain vital communications.² The main generator was reconnected to the grid at about 05:03 EDT on August 22.

Nine Mile 1. Nine Mile 1 is located 6 miles (10 km) northeast of Oswego, NY, in northern New York on Lake Ontario. It was generating about 600 MWe before the event. The reactor tripped in response to a turbine trip. The turbine tripped on light load protection (which protects the turbine against a loss of electrical load), when responding to fluctuating grid conditions. The turbine trip caused fast closure of the turbine valves, which, through acceleration relays on the control valves, create a signal to trip the reactor. After a time delay of 10 seconds, the generator tripped on reverse power.

The safety buses were automatically deenergized due to low voltage and automatically reenergized from the emergency diesel generators. Decay heat removal systems maintained the cooling function for the reactor fuel.

The lowest emergency declaration, an Unusual Event, was declared at about 16:33 EDT due to the degraded offsite power. Offsite power was restored to at least one safety bus at about 23:39 EDT on August 14. The following additional equipment problems were noted: a feedwater block valve failed “as is” on the loss of voltage, resulting in a high reactor vessel level; fuses blew in fire circuits, causing control room ventilation isolation and fire panel alarms; and operators were delayed in placing shutdown cooling in service for

several hours due to lack of procedure guidance to address particular plant conditions encountered during the shutdown. The main generator was reconnected to the grid at about 02:08 EDT on August 18.

Nine Mile 2. Nine Mile 2 is located 6 miles (10 km) northeast of Oswego, NY, in northern New York on Lake Ontario. It was generating about 1,193 MWe before the event. The reactor scrambled due to the actuation of pressure switches which detected low pressure in the hydraulic system that controls the turbine control valves. Low pressure in this system typically indicates a large load reject, for which a reactor trip is expected. In this case the pressure in the system was low because the control system was rapidly manipulating the turbine control valves to control turbine speed, which was being affected by grid frequency fluctuations.

After the reactor tripped, several reactor level control valves did not reposition, and with the main feedwater system continuing to operate, a high water level in the reactor caused a turbine trip, which caused a generator trip. Offsite power was degraded but available to the plant auxiliary buses. The offsite power dropped below the normal voltage levels, which resulted in the safety buses being automatically energized from the emergency diesel generators. Decay heat removal systems maintained the cooling function for the reactor fuel.

The lowest emergency declaration, an Unusual Event, was declared at about 17:00 EDT due to the loss of offsite power to the safety buses for more than 15 minutes. Offsite power was restored to at least one safety bus at about 01:33 EDT on August 15. The following additional equipment problem was noted: a tap changer on one of the offsite power transformers failed, complicating the restoration of one division of offsite power. The main generator was reconnected to the grid at about 19:34 EDT on August 17.

Oyster Creek. Oyster Creek is located 9 miles (14 km) south of Toms River, NJ, near the Atlantic Ocean. It was generating about 629 MWe before the event. The reactor tripped due to a turbine trip. The turbine trip was the result of a generator trip due to actuation of a high Volts/Hz protective trip. The Volts/Hz trip is a generator/transformer protective feature. The plant safety and auxiliary buses transferred from the main generator supply to the offsite power supply following the plant trip. Other than the plant transient, no equipment

or performance problems were determined to be directly related to the grid problems.

Post-trip the operators did not get the mode switch to shutdown before main steam header pressure reached its isolation setpoint. The resulting MSIV closure complicated the operator's response because the normal steam path to the main condenser was lost. The operators used the isolation condensers for decay heat removal. The plant safety and auxiliary buses remained energized from offsite power for the duration of the event, and the emergency diesel generators were not started. Decay heat removal systems maintained the cooling function for the reactor fuel. The main generator was reconnected to the grid at about 05:02 EDT on August 17.

Perry. Perry is located 7 miles (11 km) northeast of Painesville, OH, in northern Ohio on Lake Erie. It was generating about 1,275 MWe before the event. The reactor tripped due to a turbine control valve fast closure trip signal. The turbine control valve fast closure trip signal was due to a generator under-frequency trip signal that tripped the generator and the turbine and was triggered by grid frequency fluctuations. Plant operators noted voltage fluctuations and spikes on the main transformer, and the Generator Out-of-Step Supervisory relay actuated approximately 30 minutes before the trip. This supervisory relay senses a ground fault on the grid. The purpose is to prevent a remote fault on the grid from causing a generator out-of-step relay to activate, which would result in a generator trip. Approximately 30 seconds prior to the trip operators noted a number of spikes on the generator field volt meter, which subsequently went offscale high. The MVAR and MW meters likewise went offscale high.

The safety buses were deenergized and automatically reenergized from the emergency diesel generators. Decay heat removal systems maintained the cooling function for the reactor fuel. The following equipment problems were noted: a steam bypass valve opened; a reactor water clean-up system pump tripped; the off-gas system isolated, and a keep-fill pump was found to be air-bound, requiring venting and filling before the residual heat removal system loop A and the low pressure core spray system could be restored to service.

The lowest emergency declaration, an Unusual Event, was declared at about 16:20 EDT due to the loss of offsite power. Offsite power was restored to at least one safety bus at about 18:13 EDT on August 14. The main generator was reconnected

to the grid at about 23:15 EDT on August 21. After the plant restarted, a surveillance test indicated a problem with one emergency diesel generator.³

Nuclear Power Plants With a Significant Transient

The electrical disturbance on August 14 had a significant impact on seven plants that continued to remain connected to the grid. For this review, significant impact means that these plants had significant load adjustments that resulted in bypassing steam from the turbine generator, opening of relief valves, or requiring the onsite emergency diesel generators to automatically start due to low voltage.

Nuclear Power Plants With a Non-Significant Transient

Sixty-four nuclear power plants experienced non-significant transients caused by minor disturbances on the electrical grid. These plants were able to respond to the disturbances through normal control systems. Examples of these transients included changes in load of a few megawatts or changes in frequency of a few-tenths Hz.

Nuclear Power Plants With No Transient

Twenty-four nuclear power plants experienced no transient and saw essentially no disturbances on the grid, or were shut down at the time of the transient.

General Observations Based on the Facts Found During Phase One

The NWG found no evidence that the shutdown of U.S. nuclear power plants triggered the outage or inappropriately contributed to its spread (i.e., to an extent beyond the normal tripping of the plants at expected conditions). This review did not identify any activity or equipment issues that appeared to start the transient on August 14, 2003. All nine plants that experienced a reactor trip were responding to grid conditions. The severity of the transient caused generators, turbines, or reactor systems to reach a protective feature limit and actuate a plant shutdown.

All nine plants tripped in response to those conditions in a manner consistent with the plant designs. All nine plants safely shut down. All safety functions were effectively accomplished, with few problems, and the plants were maintained in a safe shutdown condition until their restart. Fermi 2, Nine Mile 1, Oyster Creek, and Perry tripped on turbine and generator protective

features. FitzPatrick, Ginna, Indian Point 2 and 3, and Nine Mile 2 tripped on reactor protective features.

Nine plants used their emergency diesel generators to power their safety-related buses during the power outage. Offsite power was restored to the safety buses after the grid was energized and the plant operators, in consultation with the transmission system operators, decided the grid was stable. Although the Oyster Creek plant tripped, offsite power was never lost to their safety buses and the emergency diesel generators did not start and were not required. Another plant, Davis-Besse, was already shut down but lost power to the safety buses. The emergency diesel generators started and provided power to the safety buses as designed.

For the eight remaining tripped plants and Davis-Besse (which was already shut down prior to the events of August 14), offsite power was restored to at least one safety bus after a period of time ranging from about 2 hours to about 14 hours, with an average time of about 7 hours. Although Ginna did not lose offsite power, the operators judged offsite power to be unstable and realigned the safety buses to the emergency diesel generators.

The licensees' return to power operation follows a deliberate process controlled by plant procedures and NRC regulations. Ginna, Indian Point 2, Nine Mile 2, and Oyster Creek resumed electrical generation on August 17. FitzPatrick and Nine Mile 1 resumed electrical generation on August 18. Fermi 2 resumed electrical generation on August 20. Perry resumed electrical generation on August 21. Indian Point 3 resumed electrical generation on

August 22. Indian Point 3 had equipment issues (failed splices in the control rod drive mechanism power system) that required repair prior to restart. Ginna submitted a special request for enforcement discretion from the NRC to permit mode changes and restart with an inoperable auxiliary feedwater pump. The NRC granted the request for enforcement discretion.

Conclusions of the U.S. Nuclear Working Group

As discussed above, the investigation of the U.S. nuclear power plant responses during the blackout found no significant deficiencies. Accordingly, there are no recommendations here concerning U.S. nuclear power plants. Some areas for consideration on a grid-wide basis were discussed and forwarded to the Electric System Working Group for their review.

On August 14, 2003, nine U.S. nuclear power plants tripped as a result of the loss of offsite power. Nuclear power plants are designed to cope with the loss of offsite power (LOOP) through the use of emergency power supplies (primarily on-site diesel generators). The safety function of most concern during a LOOP is the removal of heat from the reactor core. Although the control rods have been inserted to stop the fission process, the continuing decay of radioactive isotopes in the reactor core produces a significant amount of heat for many weeks. If this decay heat is not removed, it will cause fuel damage and the release of highly radioactive isotopes from the reactor core. The failure of the alternating current emergency power supplies in conjunction with a LOOP is known as a station blackout. Failures of the emergency

Table 8.2. Summary of Events for U. S. Nuclear Power Plants

Nuclear Plant	Unit	Operating Status at Time of Event		Response to Event	
		Full Power	Not Operating	Reactor and Turbine Trip	Emergency Diesels used
Davis-Besse (near Toledo, OH)	1		√		√
Fermi (near Toledo, OH).	2	√		√	√
James A. FitzPatrick (near Oswego, NY) . .	1	√		√	√
Ginna (near Rochester, NY)	1	√		√	√
Indian Point (near New York City, NY)	2	√		√	√
	3	√		√	√
Nine Mile Point (near Oswego, NY)	1	√		√	√
	2	√		√	√
Oyster Creek (near Toms River, NJ)	1	√		√	
Perry (near Painesville, OH)	1	√		√	√

power supplies would seriously hinder the ability of the plant operators to carry out the required safety functions. Nuclear plants can cope with a station blackout for a limited time without suffering fuel damage. However, recovery of the grid or the restoration of an emergency power supply is needed for long-term decay heat removal. For this reason, the NRC considers LOOP events to be potential precursors to more serious situations. The risk of reactor core damage increases as the LOOP frequency or duration increases.

Offsite power is considered the preferred power source for responding to all off-normal events or accidents. However, if the grid is operated in a stressed configuration, the loss of the nuclear plant generation may result in grid voltage dropping below the level needed for the plant safety loads. In that case, each plant is designed such that voltage relays will automatically disconnect the plant safety-related electrical buses from the grid and reenergize them from the emergency diesel generators (EDGs). Although the resultant safety system responses have been analyzed and found acceptable, the loss of offsite power reduces the plant's safety margin. It also increases the risk associated with failures of the EDGs. For these reasons, the NRC periodically assesses the impact of grid reliability on overall nuclear plant safety.

The NRC monitors grid reliability under its normal monitoring programs, such as the operating experience program, and has previously issued reports related to grid reliability. The NRC is continuing with an internal review of the reliability of the electrical grid and the effect on the risk profile for nuclear power plants. The NRC will consider the implications of the August 14, 2003, Northeast blackout under the NRC's regulations. The NRC is conducting an internal review of its station blackout rule, and the results of the August 14th event will be factored into that review. If there are additional findings, the NRC will address them through the NRC's normal process.

Findings of the Canadian Nuclear Working Group

Summary

On the afternoon of August 14, 2003, southern Ontario, along with the northeastern United States, experienced a widespread electrical power system outage. Eleven nuclear power plants in Ontario operating at high power levels at the time

of the event either automatically shut down as a result of the grid disturbance or automatically reduced power while waiting for the grid to be reestablished. In addition, the Point Lepreau Nuclear Generating Station in New Brunswick was forced to reduce electricity production for a short period.

The Canadian NWG (CNWG) was mandated to: review the sequence of events for each Canadian nuclear plant; determine whether any events caused or contributed to the power system outage; evaluate any potential safety issues arising as a result of the event; evaluate the effect on safety and the reliability of the grid of design features, operating procedures, and regulatory requirements at Canadian nuclear power plants; and assess the impact of associated regulator performance and regulatory decisions.

In Ontario, 11 nuclear units were operating and delivering power to the grid at the time of the grid disturbance: 4 at Bruce B, 4 at Darlington, and 3 at Pickering B. Of the 11 reactors, 7 shut down as a result of the event (1 at Bruce B, 3 at Darlington, and 3 at Pickering B). Four reactors (3 at Bruce B and 1 at Darlington) disconnected safely from the grid but were able to avoid shutting down and were available to supply power to the Ontario grid as soon as reconnection was enabled by Ontario's Independent Market Operator (IMO).

New Brunswick Power's Point Lepreau Generating Station responded to the loss of grid event by cutting power to 460 MW, returning to fully stable conditions at 16:35 EDT, within 25 minutes of the event. Hydro Québec's (HQ) grid was not affected by the power system outage, and HQ's Gentilly-2 nuclear station continued to operate normally.

Having reviewed the operating data for each plant and the responses of the power stations and their staff to the event, the CNWG concludes the following:

- ◆ None of the reactor operators had any advanced warning of impending collapse of the grid.
 - Trend data obtained indicate stable conditions until a few minutes before the event.
 - There were no prior warnings from Ontario's IMO.
- ◆ Canadian nuclear power plants did not trigger the power system outage or contribute to its spread. Rather they responded, as anticipated, in order to protect equipment and systems from

the grid disturbances. Plant data confirm the following.

- At Bruce B and Pickering B, frequency and/or voltage fluctuations on the grid resulted in the automatic disconnection of generators from the grid. For those units that were successful in maintaining the unit generators operational, reactor power was automatically reduced.
- At Darlington, load swing on the grid led to the automatic reduction in power of the four reactors. The generators were, in turn, automatically disconnected from the grid.
- Three reactors at Bruce B and one at Darlington were returned to 60% power. These reactors were available to deliver power to the grid on the instructions of the IMO.
- Three units at Darlington were placed in a zero-power hot state, and four units at Pickering B and one unit at Bruce B were placed in a guaranteed shutdown state.
- ◆ There were no risks to health and safety of workers or the public as a result of the shutdown of the reactors.
- Turbine, generator, and reactor automatic safety systems worked as designed to respond to the loss of grid.
- Station operating staff and management followed approved Operating Policies & Principles (OP&Ps) in responding to the loss of grid. At all times, operators and shift supervisors made appropriately conservative decisions in favor of protecting health and safety.

The CNWG commends the staff of Ontario Power Generation and Bruce Power for their response to the power system outage. At all times, staff acted in accordance with established OP&Ps, and took an appropriately conservative approach to decisions.

During the course of its review, the CNWG also identified the following secondary issues:

- ◆ Equipment problems and design limitations at Pickering B resulted in a temporary reduction in the effectiveness of some of the multiple safety barriers, although the equipment failure was within the unavailability targets found in the OP&Ps approved by the CNSC as part of Ontario Power Generation's licence.
- ◆ Existing OP&Ps place constraints on the use of adjuster rods to respond to events involving

rapid reductions in reactor power. While greater flexibility with respect to use of adjuster rods would not have prevented the shutdown, some units, particularly those at Darlington, might have been able to return to service less than 1 hour after the initiating event.

- ◆ Off-site power was unavailable for varying periods of time, from approximately 3 hours at Bruce B to approximately 9 hours at Pickering A. Despite the high priority assigned by the IMO to restoring power to the nuclear stations, the stations had some difficulty in obtaining timely information about the status of grid recovery and the restoration of Class IV power. This information is important for Ontario Power Generation's and Bruce Power's response strategy.
- ◆ Required regulatory approvals from CNSC staff were obtained quickly and did not delay the restart of the units; however, CNSC staff was unable to immediately activate the CNSC's Emergency Operation Centre because of loss of power to the CNSC's head office building. CNSC staff, therefore, established communications with licensees and the U.S. NRC from other locations.

Introduction

The primary focus of the CNWG during Phase I was to address nuclear power plant response relevant to the power outage of August 14, 2003. Data were collected from each power plant and analyzed in order to determine: the cause of the power outage; whether any activities at these plants caused or contributed to the power outage; and whether there were any significant safety issues. In order to obtain reliable and comparable information and data from each nuclear power plant, a questionnaire was developed to help pinpoint how each nuclear power plant responded to the August 14 grid transients. Where appropriate, additional information was obtained from the ESWG and SWG.

The operating data from each plant were compared against the plant design specifications to determine whether the plants responded as expected. Based on initial plant responses to the questionnaire, supplemental questions were developed, as required, to further clarify outstanding matters. Supplementary information on the design features of Ontario's nuclear power plants was also provided by Ontario Power Generation and Bruce Power. The CNWG also consulted a

number of subject area specialists, including CNSC staff, to validate the responses to the questionnaire and to ensure consistency in their interpretation.

In addition to the stakeholder consultations discussed in the Introduction to this chapter, CNSC staff met with officials from Ontario's Independent Market Operator on January 7, 2004.

Typical Design, Operational, and Protective Features of CANDU Nuclear Power Plants

There are 22 CANDU nuclear power reactors in Canada—20 located in Ontario at 5 multi-unit stations (Pickering A and Pickering B located in Pickering, Darlington located in the Municipality of Clarington, and Bruce A and Bruce B located near Kincardine). There are also single-unit CANDU stations at Bécancour, Québec (Gentilly-2), and Point Lepreau, New Brunswick.

In contrast to the pressurized water reactors used in the United States, which use enriched uranium fuel and a light water coolant-moderator, all housed in a single, large pressure vessel, a CANDU reactor uses fuel fabricated from natural uranium, with heavy water as the coolant and moderator. The fuel and pressurized heavy water coolant are contained in 380 to 480 pressure tubes housed in a calandria containing the heavy water moderator under low pressure. Heat generated by the fuel is removed by heavy water coolant that flows through the pressure tubes and is then circulated to the boilers to produce steam from demineralized water.

While the use of natural uranium fuel offers important benefits from the perspectives of safeguards and operating economics, one drawback is that it restricts the ability of a CANDU reactor to recover from a large power reduction. In particular, the lower reactivity of natural uranium fuel means that CANDU reactors are designed with a small number of control rods (called “adjuster rods”) that are only capable of accommodating power reductions to 60%. The consequence of a larger power reduction is that the reactor will “poison out” and cannot be made critical for up to 2 days following a power reduction. By comparison, the use of enriched fuel enables a typical pressurized water reactor to operate with a large number of control rods that can be withdrawn to accommodate power reductions to zero power.

A unique feature of some CANDU plants—namely, Bruce B and Darlington—is a capability to

maintain the reactor at 60% full power if the generator becomes disconnected from the grid and to maintain this “readiness” condition if necessary for days. Once reconnected to the grid, the unit can be loaded to 60% full power within several minutes and can achieve full power within 24 hours.

As with other nuclear reactors, CANDU reactors normally operate continuously at full power except when shut down for maintenance and inspections. As such, while they provide a stable source of baseload power generation, they cannot provide significant additional power in response to sudden increases in demand. CANDU power plants are not designed for black-start operation; that is, they are not designed to start up in the absence of power from the grid.

Electrical Distribution Systems

The electrical distribution systems at nuclear power plants are designed to satisfy the high safety and reliability requirements for nuclear systems. This is achieved through flexible bus arrangements, high capacity standby power generation, and ample redundancy in equipment.

Where continuous power is required, power is supplied either from batteries (for continuous DC power, Class I) or via inverters (for continuous AC power, Class II). AC supply for safety-related equipment, which can withstand short interruption (on the order of 5 minutes), is provided by Class III power. Class III power is nominally supplied through Class IV; when Class IV becomes unavailable, standby generators are started automatically, and the safety-related loads are picked up within 5 minutes of the loss of Class IV power.

The Class IV power is an AC supply to reactor equipment and systems that can withstand longer interruptions in power. Class IV power can be supplied either from the generator through a transformer or from the grid by another transformer. Class IV power is not required for reactors to shut down safely.

In addition to the four classes of power described above, there is an additional source of power known as the Emergency Power System (EPS). EPS is a separate power system consisting of its own on-site power generation and AC and DC distribution systems whose normal supply is from the Class III power system. The purpose of the EPS system is to provide power to selected safety-related loads following common mode incidents, such as seismic events.

Protective Features of CANDU Nuclear Power Plants

CANDU reactors typically have two separate, independent and diverse systems to shut down the reactor in the event of an accident or transients in the grid. Shutdown System 1 (SDS1) consists of a large number of cadmium rods that drop into the core to decrease the power level by absorbing neutrons. Shutdown System 2 (SDS2) consists of high-pressure injection of gadolinium nitrate into the low-pressure moderator to decrease the power level by absorbing neutrons. Although Pickering A does not have a fully independent SDS2, it does have a second shutdown mechanism, namely, the fast drain of the moderator out of the calandria; removal of the moderator significantly reduces the rate of nuclear fission, which reduces reactor power. Also, additional trip circuits and shutoff rods have recently been added to Pickering A Unit 4 (Shutdown System Enhancement, or SDS-E). Both SDS1 and SDS2 are capable of reducing reactor power from 100% to about 2% within a few seconds of trip initiation.

Fuel Heat Removal Features of CANDU Nuclear Power Plants

Following the loss of Class IV power and shutdown of the reactor through action of SDS1 and/or SDS2, significant heat will continue to be generated in the reactor fuel from the decay of fission products. The CANDU design philosophy is to provide defense in depth in the heat removal systems.

Immediately following the trip and prior to restoration of Class III power, heat will be removed from the reactor core by natural circulation of coolant through the Heat Transport System main circuit following rundown of the main Heat Transport pumps (first by thermosyphoning and later by intermittent buoyancy induced flow). Heat will be rejected from the secondary side of the steam generators through the atmospheric steam discharge valves. This mode of operation can be sustained for many days with additional feedwater supplied to the steam generators via the Class III powered auxiliary steam generator feed pump(s).

In the event that the auxiliary feedwater system becomes unavailable, there are two alternate EPS powered water supplies to steam generators, namely, the Steam Generator Emergency Coolant System and the Emergency Service Water System. Finally, a separate and independent means of cooling the fuel is by forced circulation by means

of the Class III powered shutdown cooling system; heat removal to the shutdown cooling heat exchangers is by means of the Class III powered components of the Service Water System.

CANDU Reactor Response to Loss-of-Grid Event

Response to Loss of Grid

In the event of disconnection from the grid, power to shut down the reactor safely and maintain essential systems will be supplied from batteries and standby generators. The specific response of a reactor to disconnection from the grid will depend on the reactor design and the condition of the unit at the time of the event.

60% Reactor Power: All CANDU reactors are designed to operate at 60% of full power following the loss of off-site power. They can operate at this level as long as demineralized water is available for the boilers. At Darlington and Bruce B, steam can be diverted to the condensers and recirculated to the boilers. At Pickering A and Pickering B, excess steam is vented to the atmosphere, thereby limiting the operating time to the available inventory of demineralized water.

0% Reactor Power, Hot: The successful transition from 100% to 60% power depends on several systems responding properly, and continued operation is not guaranteed. The reactor may shut down automatically through the operation of the process control systems or through the action of either of the shutdown systems.

Should a reactor shutdown occur following a load rejection, both Class IV power supplies (from the generator and the grid) to that unit will become unavailable. The main Heat Transport pumps will trip, leading to a loss of forced circulation of coolant through the core. Decay heat will be continuously removed through natural circulation (thermosyphoning) to the boilers, and steam produced in the boilers will be exhausted to the atmosphere via atmospheric steam discharge valves. The Heat Transport System will be maintained at around 250 to 265 degrees Celsius during thermosyphoning. Standby generators will start automatically and restore Class III power to key safety-related systems. Forced circulation in the Heat Transport System will be restored once either Class III or Class IV power is available.

When shut down, the natural decay of fission products will lead to the temporary buildup of

neutron absorbing elements in the fuel. If the reactor is not quickly restarted to reverse this natural process, it will “poison-out.” Once poisoned-out, the reactor cannot return to operation until the fission products have further decayed, a process which typically takes up to 2 days.

Overpoisoned Guaranteed Shutdown State: In the event that certain problems are identified when reviewing the state of the reactor after a significant transient, the operating staff will cool down and depressurize the reactor, then place it in an overpoisoned guaranteed shutdown state (GSS) through the dissolution of gadolinium nitrate into the moderator. Maintenance will then be initiated to correct the problem.

Return to Service Following Loss of Grid

The return to service of a unit following any one of the above responses to a loss-of-grid event is discussed below. It is important to note that the descriptions provided relate to operations on a single unit. At multi-unit stations, the return to service of several units cannot always proceed in parallel, due to constraints on labor availability and the need to focus on critical evolutions, such as taking the reactor from a subcritical to a critical state.

60% Reactor Power: In this state, the unit can be resynchronized consistent with system demand, and power can be increased gradually to full power over approximately 24 hours.

0% Reactor Power, Hot: In this state, after approximately 2 days for the poison-out, the turbine can be run up and the unit synchronized. Thereafter, power can be increased to high power over the next day. This restart timeline does not include the time required for any repairs or maintenance that might have been necessary during the outage.

Overpoisoned Guaranteed Shutdown State: Placing the reactor in a GSS after it has been shut down requires approximately 2 days. Once the condition that required entry to the GSS is rectified, the restart requires removal of the guarantee, removal of the gadolinium nitrate through ion exchange process, heatup of the Heat Transport System, and finally synchronization to the grid. Approximately 4 days are required to complete these restart activities. In total, 6 days from shutdown are required to return a unit to service from the GSS, and this excludes any repairs that might have been required while in the GSS.

Summary of Canadian Nuclear Power Plant Response to and Safety During the August 14 Outage

On the afternoon of August 14, 2003, 15 Canadian nuclear units were operating: 13 in Ontario, 1 in Québec, and 1 in New Brunswick. Of the 13 Ontario reactors that were critical at the time of the event, 11 were operating at or near full power and 2 at low power (Pickering B Unit 7 and Pickering A Unit 4). All 13 of the Ontario reactors disconnected from the grid as a result of the grid disturbance. Seven of the 11 reactors operating at high power shut down, while the remaining 4 operated in a planned manner that enabled them to remain available to reconnect to the grid at the request of Ontario’s IMO. Of the 2 Ontario reactors operating at low power, Pickering A Unit 4 tripped automatically, and Pickering B Unit 7 was tripped manually and shut down. In addition, a transient was experienced at New Brunswick Power’s Point Lepreau Nuclear Generating Station, resulting in a reduction in power. Hydro Québec’s Gentilly-2 nuclear station continued to operate normally as the Hydro Québec grid was not affected by the grid disturbance.

Nuclear Power Plants With Significant Transients

Pickering Nuclear Generating Station. The Pickering Nuclear Generating Station (PNGS) is located in Pickering, Ontario, on the shores of Lake Ontario, 19 miles (30 km) east of Toronto. It houses 8 nuclear reactors, each capable of delivering 515 MW to the grid. Three of the 4 units at Pickering A (Units 1 through 3) have been shut down since late 1997. Unit 4 was restarted earlier this year following a major refurbishment and was in the process of being commissioned at the time of the event. At Pickering B, 3 units were operating at or near 100% prior to the event, and Unit 7 was being started up following a planned maintenance outage.

Pickering A. As part of the commissioning process, Unit 4 at Pickering A was operating at 12% power in preparation for synchronization to the grid. The reactor automatically tripped on SDS1 due to Heat Transport Low Coolant Flow, when the Heat Transport main circulating pumps ran down following the Class IV power loss. The decision was then made to return Unit 4 to the guaranteed shutdown state. Unit 4 was synchronized to the grid on August 20, 2003. Units 1, 2 and 3 were in lay-up mode.

Pickering B. The Unit 5 Generator Excitation System transferred to manual control due to large voltage oscillations on the grid at 16:10 EDT and then tripped on Loss of Excitation about 1 second later (prior to grid frequency collapse). In response to the generator trip, Class IV buses transferred to the system transformer and the reactor setback. The grid frequency collapse caused the System Service Transformer to disconnect from the grid, resulting in a total loss of Class IV power. The reactor consequently tripped on the SDS1 Low Gross Flow parameter followed by an SDS2 trip due to Low Core Differential Pressure.

The Unit 6 Generator Excitation System also transferred to manual control at 16:10 EDT due to large voltage oscillations on the grid and the generator remained connected to the grid in manual voltage control. Approximately 65 seconds into the event, the grid under-frequency caused all the Class IV buses to transfer to the Generator Service Transformer. Ten seconds later, the generator separated from the Grid. Five seconds later, the generator tripped on Loss of Excitation, which caused a total loss of Class IV power. The reactor consequently tripped on the SDS1 Low Gross Flow parameter, followed by an SDS2 trip due to Low Core Differential Pressure.

Unit 7 was coming back from a planned maintenance outage and was at 0.9% power at the time of the event. The unit was manually tripped after loss of Class IV power, in accordance with procedures and returned to guaranteed shutdown state.

Unit 8 reactor automatically set back on load rejection. The setback would normally have been terminated at 20% power but continued to 2% power because of the low boiler levels. The unit subsequently tripped on the SDS1 Low Boiler Feedline Pressure parameter due to a power mismatch between the reactor and the turbine.

The following equipment problems were noted. At Pickering, the High Pressure Emergency Coolant Injection System (HPECIS) pumps are designed to operate from a Class IV power supply. As a result of the shutdown of all the operating units, the HPECIS at both Pickering A and Pickering B became unavailable for 5.5 hours. (The design of Pickering A and Pickering B HPECIS must be such that the fraction of time for which it is not available can be demonstrated to be less than 10^{-3} years—about 8 hours per year. This was the first unavailability of the HPECIS for 2003.) In addition, Emergency High Pressure Service Water System restoration for all Pickering B units was

delayed because of low suction pressure supplying the Emergency High Pressure Service Water pumps. Manual operator intervention was required to restore some pumps back to service.

Units were synchronized to the grid as follows: Unit 8 on August 22, Unit 5 on August 23, Unit 6 on August 25, and Unit 7 on August 29.

Darlington Nuclear Generating Station. Four reactors are located at the Darlington Nuclear Generation Station, which is on the shores of Lake Ontario in the Municipality of Clarington, 43 miles (70 km) east of Toronto. All four of the reactors are licensed to operate at 100% of full power, and each is capable of delivering approximately 880 MW to the grid.

Unit 1 automatically stepped back to the 60% reactor power state upon load rejection at 16:12 EDT. Approval by the shift supervisor to automatically withdraw the adjuster rods could not be provided due to the brief period of time for the shift supervisor to complete the verification of systems as per procedure. The decreasing steam pressure and turbine frequency then required the reactor to be manually tripped on SDS1, as per procedure for loss of Class IV power. The trip occurred at 16:24 EDT, followed by a manual turbine trip due to under-frequency concerns.

Like Unit 1, Unit 2 automatically stepped back upon load rejection at 16:12 EDT. As with Unit 1, there was insufficient time for the shift supervisor to complete the verification of systems, and faced with decreasing steam pressure and turbine frequency, the decision was made to shut down Unit 2. Due to under-frequency on the main Primary Heat Transport pumps, the turbine was tripped manually which resulted in an SDS1 trip at 16:28 EDT.

Unit 3 experienced a load rejection at 16:12 EDT, and during the stepback Unit 3 was able to sustain operation with steam directed to the condensers. After system verifications were complete, approval to place the adjuster rods on automatic was obtained in time to recover, at 59% reactor power. The unit was available to resynchronize to the grid.

Unit 4 experienced a load rejection at 16:12 EDT, and required a manual SDS1 trip due to the loss of Class II bus. This was followed by a manual turbine trip.

The following equipment problems were noted: Unit 4 Class II inverter trip on BUS A3 and

subsequent loss of critical loads prevented unit recovery. The Unit 0 Emergency Power System BUS B135 power was lost until the Class III power was restored. (A planned battery bank B135 change out was in progress at the time of the blackout.)

Units were synchronized to the grid as follows: Unit 3 at 22:00 EDT on August 14; Unit 2 on August 17, 2003; Unit 1 on August 18, 2003; and Unit 4 on August 18, 2003.

Bruce Power. Eight reactors are located at Bruce Power on the eastern shore of Lake Huron between Kincardine and Port Elgin, Ontario. Units 5 through 8 are capable of generating 840 MW each. Presently these reactors are operating at 90% of full power due to license conditions imposed by the CNSC. Units 1 through 4 have been shut down since December 31, 1997. At the time of the event, work was being performed to return Units 3 and 4 to service.

Bruce A. Although these reactors were in guaranteed shutdown state, they were manually tripped, in accordance with operating procedures. SDS1 was manually tripped on Units 3 and 4, as per procedures for a loss of Class IV power event. SDS1 was re-poised on both units when the station power supplies were stabilized. The emergency transfer system functioned as per design, with the Class III standby generators picking up station electrical loads. The recently installed Qualified Diesel Generators received a start signal and were available to pick up emergency loads if necessary.

Bruce B. Units 5, 6, 7, and 8 experienced initial generation rejection and accompanying stepback on all four reactor units. All generators separated from the grid on under-frequency at 16:12 EDT. Units 5, 7, and 8 maintained reactor power at 60% of full power and were immediately available for reconnection to the grid.

Although initially surviving the loss of grid event, Unit 6 experienced an SDS1 trip on insufficient Neutron Over Power (NOP) margin. This occurred while withdrawing Bank 3 of the adjusters in an attempt to offset the xenon transient, resulting in a loss of Class IV power.

The following equipment problems were noted: An adjuster rod on Unit 6 had been identified on August 13, 2003, as not working correctly. Unit 6 experienced a High Pressure Recirculation Water line leak, and the Closed Loop Demineralized Water loop lost inventory to the Emergency Water Supply System.

Units were synchronized to the grid as follows: Unit 8 at 19:14 EDT on August 14, 2003; Unit 5 at 21:04 EDT on August 14; and Unit 7 at 21:14 EDT on August 14, 2003. Unit 6 was resynchronized at 02:03 EDT on August 23, 2003, after maintenance was conducted.

Point Lepreau Nuclear Generating Station. The Point Lepreau nuclear station overlooks the Bay of Fundy on the Lepreau Peninsula, 25 miles (40 km) southwest of Saint John, New Brunswick. Point Lepreau is a single-unit CANDU 6, designed for a gross output of 680 MW. It is owned and operated by New Brunswick Power.

Point Lepreau was operating at 91.5% of full power (610 MWe) at the time of the event. When the event occurred, the unit responded to changes in grid frequency as per design. The net impact was a short-term drop in output by 140 MW, with reactor power remaining constant and excess thermal energy being discharged via the unit steam discharge valves. During the 25 seconds of the event, the unit stabilizer operated numerous times to help dampen the turbine generator speed oscillations that were being introduced by the grid frequency changes. Within 25 minutes of the event initiation, the turbine generator was reloaded to 610 MW. Given the nature of the event that occurred, there were no unexpected observations on the New Brunswick Power grid or at Point Lepreau Generating Station throughout the ensuing transient.

Nuclear Power Plants With No Transient

Gentilly-2 Nuclear Station. Hydro Québec owns and operates Gentilly-2 nuclear station, located on the south shore of the St. Lawrence River opposite the city of Trois-Rivières, Québec. Gentilly-2 is capable of delivering approximately 675 MW to Hydro Québec's grid. The Hydro Québec grid was not affected by the power system outage and Gentilly-2 continued to operate normally.

General Observations Based on the Facts Found During Phase I

Following the review of the data provided by the Canadian nuclear power plants, the CNWG concludes the following:

- ◆ None of the reactor operators had any advanced warning of impending collapse of the grid.
- ◆ Canadian nuclear power plants did not trigger the power system outage or contribute to its spread.

- ◆ There were no risks to the health and safety of workers or the public as a result of the concurrent shutdown of several reactors. Automatic safety systems for the turbine generators and reactors worked as designed. (See Table 8.3 for a summary of shutdown events for Canadian nuclear power plants.)

The CNWG also identified the following secondary issues:

- ◆ Equipment problems and design limitations at Pickering B resulted in a temporary reduction in the effectiveness of some of the multiple safety barriers, although the equipment failure was within the unavailability targets found in the OP&Ps approved by the CNSC as part of Ontario Power Generation’s license.
- ◆ Existing OP&Ps place constraints on the use of adjuster rods to respond to events involving

rapid reductions in reactor power. While greater flexibility with respect to use of adjuster rods would not have prevented the shutdown, some units, particularly those at Darlington, might have been able to return to service less than 1 hour after the initiating event.

- ◆ Off-site power was unavailable for varying periods of time, from approximately 3 hours at Bruce B to approximately 9 hours at Pickering A. Despite the high priority assigned by the IMO to restoring power to the nuclear stations, the stations had some difficulty obtaining timely information about the status of grid recovery and the restoration of Class IV power. This information is important for Ontario Power Generation’s and Bruce Power’s response strategy.
- ◆ Required regulatory approvals from CNSC staff were obtained quickly and did not delay the

Table 8.3. Summary of Shutdown Events for Canadian Nuclear Power Plants

Generating Station	Unit	Operating Status at Time of Event			Response to Event			
		Full Power	Startup	Not Operating	Stepback to 60% Power, Available To Supply Grid	Turbine Trip	Reactor Trip	
							SDS1	SDS2
Pickering NGS	1			√			(a)	
	2			√				
	3			√				
	4		√				√	(b)
	5	√					√	√
	6	√					√	√
	7		√				√	
	8	√					√	
Darlington NGS	1	√				√	√	
	2	√				√	√	
	3	√			√			
	4	√				√	√	
Bruce Nuclear Power Development	1			√				
	2			√				
	3			√			√	
	4			√			√	
	5	√			√			
	6	√					√	
	7	√			√			
	8	√			√			

^aPickering A Unit 1 tripped as a result of electrical bus configuration immediately prior to the event which resulted in a temporary loss of Class II power.

^bPickering A Unit 4 also tripped on SDS-E.

Notes: Unit 7 at Pickering B was operating at low power, warming up prior to reconnecting to the grid after a maintenance outage. Unit 4 at Pickering A was producing at low power, as part of the reactor’s commissioning after extensive refurbishment since being shut down in 1997.

restart of the units; however, CNSC staff was unable to immediately activate the CNSC's Emergency Operation Centre because of loss of power to the CNSC's head office building. CNSC staff, therefore, established communications with licensees and the U.S. NRC from other locations.

Regulatory Activities Subsequent to the Blackout

The actuation of emergency shutdown systems at Bruce, Darlington and Pickering, and the impairment of the High Pressure Emergency Coolant Injection System (HPECIS) at Pickering are events for which licensees need to file reports with the Canadian Nuclear Safety Commission (CNSC), in accordance with Regulatory Standard S 99, "Reporting Requirements for Operating Nuclear Power Plants." Reports have been submitted by Ontario Power Generation (OPG) and Bruce Power, and are being followed up by staff from the CNSC as part of the CNSC's normal regulatory process. This includes CNSC's review and approval, where appropriate, of any actions taken or proposed to be taken to correct any problems in design, equipment or operating procedures identified by OPG and Bruce Power.

As a result of further information about the event gathered by CNSC staff during followup inspections, the temporary impairment of the HPECIS at Pickering has been rated by CNSC staff as Level 2 on the International Nuclear Event Scale, indicating that there was a significant failure in safety provisions, but with sufficient backup systems, or "defense-in-depth," in place to cope with potential malfunctions. Since August 2003, OPG has implemented procedural and operational changes to improve the performance of the safety systems at Pickering.

Conclusions of the Canadian Nuclear Working Group

As discussed above, Canadian nuclear power plants did not trigger the power system outage or contribute to its spread. The CNWG therefore made no recommendations with respect to the design or operation of Canadian nuclear plants to improve the reliability of the Ontario electricity grid.

The CNWG made two recommendations, one concerning backup electrical generation equipment to the CNSC's Emergency Operations Centre and

another concerning the use of adjuster rods during future events involving the loss of off-site power. These are presented in Chapter 10 along with the Task Force's recommendations on other subjects.

Despite some comments to the contrary, the CNWG's investigation found that the time to restart the reactors was reasonable and in line with design specifications for the reactors. Therefore, the CNWG made no recommendations for action on this matter. Comments were also made regarding the adequacy of generation capacity in Ontario and the appropriate mix of technologies for electricity generation. This is a matter beyond the CNWG's mandate, and it made no recommendations on this issue.

Perspective of Nuclear Regulatory Agencies on Potential Changes to the Grid

The NRC and the CNSC, under their respective regulatory authorities, are entrusted with providing reasonable assurance of adequate protection of public health and safety. As the design and operation of the electricity grid is taken into account when evaluating the safety analysis of nuclear power plants, changes to the electricity grid must be evaluated for the impact on plant safety. As the Task Force final recommendations result in actions to affect changes, the NRC and the CNSC will assist by evaluating potential effects on the safety of nuclear power plant operation.

The NRC and the CNSC acknowledge that future improvements in grid reliability will involve coordination among many groups. The NRC and the CNSC intend to maintain the good working relationships that have been developed during the Task Force investigation to ensure that we continue to share experience and insights and work together to maintain an effective and reliable electric supply system.

Endnotes

¹ Further details are available in the NRC Special Inspection Report dated December 22, 2003, ADAMS Accession No. ML033570386.

² Further details are available in the NRC Special Inspection Report dated December 22, 2003, ADAMS Accession No. ML033570386.

³ Further details are available in the NRC Special Inspection Report dated October 10, 2003, ADAMS Accession No. ML032880107.

9. Physical and Cyber Security Aspects of the Blackout

Summary and Primary Findings

After the Task Force Interim Report was issued in November 2003, the Security Working Group (SWG) continued in its efforts to investigate whether a malicious cyber event directly caused or significantly contributed to the power outage of August 14, 2003. These efforts included additional analyses of interviews conducted prior to the release of the Interim Report and additional consultations with representatives from the electric power sector. The information gathered from these efforts validated the SWG's Interim Report preliminary findings and the SWG found no reason to amend, alter, or negate any of the information submitted to the Task Force for the Interim Report.

Specifically, further analysis by the SWG found no evidence that malicious actors caused or contributed to the power outage, nor is there evidence that worms or viruses circulating on the Internet at the time of the power outage had an effect on power generation and delivery systems of the companies directly involved in the power outage. The SWG acknowledges reports of al-Qaeda claims of responsibility for the power outage of August 14, 2003. However, these claims are not consistent with the SWG's findings. SWG analysis also brought to light certain concerns respecting the possible failure of alarm software; links to control and data acquisition software; and the lack of a system or process for some grid operators to adequately view the status of electric systems outside of their immediate control.

After the release of the Interim Report in November 2003, the SWG determined that the existing data, and the findings derived from analysis of those data, provided sufficient certainty to exclude the probability that a malicious cyber event directly caused or significantly contributed to the power outage events. As such, further data collection efforts to conduct broader analysis were deemed unnecessary. While no additional data were collected, further analysis and interviews

conducted after the release of the Interim Report allowed the SWG to validate its preliminary findings and the SWG to make recommendations on those findings:

- ◆ Interviews and analyses conducted by the SWG indicate that within some of the companies interviewed there are potential opportunities for cyber system compromise of Energy Management Systems (EMS) and their supporting information technology (IT) infrastructure. Indications of procedural and technical IT management vulnerabilities were observed in some facilities, such as unnecessary software services not denied by default, loosely controlled system access and perimeter control, poor patch and configuration management, and poor system security documentation. This situation caused the SWG to support the promulgation, implementation, and enforcement of cyber and physical security standards for the electric power sector.

Recommendation
32, page 163

- ◆ A failure in a software program not linked to malicious activity may have significantly contributed to the power outage. Since the issuance of the Interim Report, the SWG consulted with the software program's vendor and confirmed that since the August 14, 2003, power outage, the vendor provided industry with the necessary information and mitigation steps to address this software failure. In Canada, a survey was posted on the Canadian Electricity Association (CEA) secure members-only web site to determine if the software was in use. The responses indicated that it is not used by Canadian companies in the industry.

Recommendation
33, page 164

- ◆ Internal and external links from Supervisory Control and Data Acquisition (SCADA) networks to other systems introduced vulnerabilities.

Recommendation
34, page 165

◆ In some cases, Control Area (CA) and Reliability Coordinator (RC) visibility into the operations of surrounding areas was lacking.

Recommendation
35, page 165

The SWG’s analysis is reflected in a total of 15 recommendations, two of which were combined with similar concerns by the ESWG (Recommendations 19 and 22); for the remaining 13, see Recommendations 32-44 (pages 163-169).

Overall, the SWG’s final report was the result of interviews conducted with representatives of Cinergy, FirstEnergy, American Electric Power (AEP), PJM Interconnect, the Midwest Independent System Operator (MISO), the East Central Area Reliability Coordinating Agreement (ECAR), and GE Power Systems Division. These entities were chosen due to their proximity to the causes of the power outage based on the analysis of the Electric System Working Group (ESWG). The findings contained in this report relate only to those entities surveyed. The final report also incorporates information gathered from third party sources as well as federal security and intelligence communities.

In summary, SWG analysis provided no evidence that a malicious cyber attack was a direct or indirect cause of the August 14, 2003, power outage. This conclusion is supported by the SWG’s event timeline, detailed later in this chapter, which explains in detail the series of non-malicious human and cyber failures that ultimately resulted in the power outage. In the course of its analysis the SWG, however, did identify a number of areas of concern respecting cyber security aspects of the electricity sector.

SWG Mandate and Scope

It is widely recognized that the increased reliance on IT by critical infrastructure sectors, including the energy sector, has increased the vulnerability of these systems to disruption via cyber means. The ability to exploit these vulnerabilities has been demonstrated in North America. The SWG was comprised of United States and Canadian federal, state, provincial and local experts in both physical and cyber security and its objective was to determine the role, if any, that a malicious cyber event played in causing, or contributing to, the power outage of August 14, 2003. For the purposes

of its work, the SWG defined a “malicious cyber event” as the manipulation of data, software or hardware for the purpose of deliberately disrupting the systems that control and support the generation and delivery of electric power.

The SWG worked closely with the United States and Canadian law enforcement, intelligence and homeland security communities to examine the possible role of malicious actors in the power outage. A primary activity in this endeavor was the collection and review of available intelligence related to the power outage of August 14, 2003. The SWG also collaborated with the energy industry to examine the cyber systems that control power generation and delivery operations, the physical security of cyber assets, cyber policies and procedures and the functionality of supporting infrastructures—such as communication systems and backup power generation, which facilitate the smooth running operation of cyber assets—to determine if the operation of these systems was affected by malicious activity. The SWG coordinated its efforts with those of other Working Groups and there was a significant interdependence on each groups work products and findings. The SWG’s focus was on the cyber operations of those companies in the United States involved in the early stages of the power outage timeline, as identified by the ESWG.

Outside of the SWG’s scope was the examination of the non-cyber physical infrastructure aspects of the power outage of August 14, 2003. The Interim Report detailed the SWG’s availability to investigate breaches of physical security unrelated to the cyber dimensions of the infrastructure on behalf of the Task Force but no incidents came to the SWG’s attention during its work. Also outside of the scope of the SWG’s work was analysis of the impacts the power outage had on other critical infrastructure sectors. Both Public Safety and Emergency Preparedness Canada and the U.S. Department of Homeland Security (DHS) examined these issues, but not within the context of the SWG.

Cyber Security in the Electricity Sector

The generation and delivery of electricity has been, and continues to be, a target of malicious groups and individuals intent on disrupting this system. Even attacks that do not directly target the electricity sector can have disruptive effects on

electricity system operations. Many malicious code attacks, by their very nature, are unbiased and tend to interfere with operations supported by vulnerable applications. One such incident occurred in January 2003, when the “Slammer” Internet worm took down monitoring computers at FirstEnergy Corporation’s idled Davis-Besse nuclear plant. A subsequent report by the North American Electric Reliability Council (NERC) concluded that although the infection caused no outages, it blocked commands that operated other power utilities.¹

This example, among others, highlights the increased vulnerability to disruption via cyber means faced by North America’s critical infrastructure sectors, including the energy sector. Of specific concern to the United States and Canadian governments are the SCADA networks, which contain computers and applications that perform a wide variety of functions across many industries. In electric power, SCADA includes telemetry for status and control, as well as EMS, protective relaying and automatic generation control. SCADA systems were developed to maximize functionality and interoperability, with little attention given to cyber security. These systems, many of which were intended to be isolated, now find themselves for a variety of business and operational reasons, either directly or indirectly connected to the global Internet. For example, in some instances, there may be a need for employees to monitor SCADA systems remotely. However, connecting SCADA systems to a remotely accessible computer network can present security risks. These risks include the compromise of sensitive operating information and the threat of unauthorized access to SCADA systems’ control mechanisms.

Security has always been a priority for the electricity sector in North America; however, it is a greater priority now than ever before. CAs and RCs recognize that the threat environment is changing and that the risks are greater than in the past, and they have taken steps towards improving their security postures. NERC’s Critical Infrastructure Protection Advisory Group has been examining ways to improve both the physical and cyber security dimensions of the North American power grid. This group is comprised of Canadian and U.S. industry experts in the areas of cyber security, physical security and operational security. The creation of a national SCADA program is now also under discussion in the U.S. to improve the physical and cyber security of these control

systems. The Canadian Electricity Association’s Critical Infrastructure Working Group is examining similar measures.

Information Collection and Analysis

After analyzing information already obtained from stakeholder interviews, telephone transcripts, law enforcement and intelligence information, and other ESWG working documents, the SWG determined that it was not necessary to analyze other sources of data on the cyber operations of those such as log data from routers, intrusion detection systems, firewalls, EMS, change management logs, and physical security materials.

The SWG was divided into six sub-teams to address the discrete components of this investigation: Cyber Analysis, Intelligence Analysis, Physical Analysis, Policies and Procedures, Supporting Infrastructure, and Root Cause Liaison. The SWG organized itself in this manner to create a holistic approach to address each of the main areas of concern with regards to power grid vulnerabilities. Rather than analyze each area of concern separately, the SWG sub-team structure provided a more comprehensive framework in which to investigate whether malicious activity was a cause of the power outage of August 14, 2003. Each sub-team was staffed with Subject Matter Experts (SMEs) from government, industry, and academia to provide the analytical breadth and depth necessary to complete each sub-team’s objective. A detailed overview of the sub-team structure and activities for each sub-team is provided below.

1. Cyber Analysis

The Cyber Analysis sub-team was led by the CERT® Coordination Center (CERT/CC) at Carnegie Mellon University and the Royal Canadian Mounted Police (RCMP). This team was focused on analyzing and reviewing electronic media of computer networks in which online communications take place. The sub-team examined these networks to determine if they were maliciously used to cause, or contribute to the August 14, 2003, outage. Specifically, the SWG reviewed materials created on behalf of DHS’s National Communication System (NCS). These materials covered the analysis and conclusions of their Internet Protocol (IP) modeling correlation study of Blaster (a malicious Internet worm first noticed on August 11, 2003) and the power outage. This

NCS analysis supports the SWG's finding that viruses and worms prevalent across the Internet at the time of the outage did not have any significant impact on power generation and delivery systems. The team also conducted interviews with vendors to identify known system flaws and vulnerabilities.

This sub-team took a number of steps, including reviewing NERC reliability standards to gain a better understanding of the overall security posture of the electric power industry. Additionally, the sub-team participated in meetings in Baltimore on August 22 and 23, 2003. The meetings provided an opportunity for the cyber experts and the power industry experts to understand the details necessary to conduct an investigation.

Members of the sub-team also participated in the NERC/Department of Energy (DOE) Fact Finding meeting held in Newark, New Jersey on September 8, 2003. Each company involved in the outage provided answers to a set of questions related to the outage. The meeting helped to provide a better understanding of what each company experienced before, during and after the outage. Additionally, sub-team members participated in interviews with grid operators from FirstEnergy on October 8 and 9, 2003, and from Cinergy on October 10, 2003.

2. Intelligence Analysis

The Intelligence Analysis sub-team was led by DHS and the RCMP, which worked closely with Federal, State and local law enforcement, intelligence and homeland security organizations to assess whether the power outage was the result of a malicious attack.

SWG analysis provided no evidence that malicious actors—be they individuals or organizations—were responsible for, or contributed to, the power outage of August 14, 2003. Additionally, the sub-team found no indication of deliberate physical damage to power generating stations and delivery lines on the day of the outage and there were no reports indicating the power outage was caused by a computer network attack.

Both U.S. and Canadian government authorities provide threat intelligence information to their respective energy sectors when appropriate. No intelligence reports prior to, during or after the power outage indicated any specific terrorist plans or operations against the energy infrastructure. There was, however, threat information of a

general nature relating to the sector which was provided to the North American energy industry by U.S. and Canadian Government agencies in late July 2003. This information indicated that al-Qaeda might attempt to carry out a physical attack involving explosions at oil production facilities, power plants or nuclear plants on the east coast of the U.S. during the summer of 2003. The type of physical attack described in the intelligence that prompted this threat warning is not consistent with the events causing the power outage as there was no indication of a kinetic event before, during, or immediately after the power outage of August 14, 2003.

Despite all of the above indications that no terrorist activity caused the power outage, al-Qaeda publicly claimed responsibility for its occurrence:

◆ *August 18, 2003:* Al-Hayat, an Egyptian media outlet, published excerpts from a communiqué attributed to al-Qaeda. Al Hayat claimed to have obtained the communiqué from the website of the International Islamic Media Center. The content of the communiqué asserts that the “brigades of Abu Fahes Al Masri had hit two main power plants supplying the East of the U.S., as well as major industrial cities in the U.S. and Canada, . . . its ally in the war against Islam (New York and Toronto) and their neighbors.” Furthermore, the operation “was carried out on the orders of Osama bin Laden to hit the pillars of the U.S. economy,” as “a realization of bin Laden’s promise to offer the Iraqi people a present.” The communiqué does not specify the way the alleged sabotage was carried out, but does elaborate on the alleged damage the sabotage caused to the U.S. economy in the areas of finance, transportation, energy and telecommunications.

Additional claims and commentary regarding the power outage appeared in various Middle Eastern media outlets:

◆ *August 26, 2003:* A conservative Iranian daily newspaper published a commentary regarding the potential of computer technology as a tool for terrorists against infrastructures dependent on computer networks, most notably water, electric, public transportation, trade organizations and “supranational” companies in the United States.

◆ *September 4, 2003:* An Islamist participant in a Jihadist chat room forum claimed that sleeper cells associated with al-Qaeda used the power

outage as a cover to infiltrate the U.S. from Canada.

However, these claims as known are not consistent with the SWG's findings. They are also not consistent with congressional testimony of the Federal Bureau of Investigation (FBI). Larry A. Mefford, Executive Assistant Director in charge of the FBI's Counterterrorism and Counterintelligence programs, testified in U.S. Congress on September 4, 2003, that:

*"To date, we have not discovered any evidence indicating that the outage was a result of activity by international or domestic terrorists or other criminal activity."*²

Mr. Mefford also testified that:

*"The FBI has received no specific, credible threats to electronic power grids in the United States in the recent past and the claim of the Abu Hafs al-Masri Brigade to have caused the blackout appears to be no more than wishful thinking. We have no information confirming the actual existence of this group."*³

Current assessments suggest that there are terrorists and other malicious actors who have the capability to conduct a malicious cyber attack with potential to disrupt the energy infrastructure. Although such an attack cannot be ruled out entirely, an examination of available information and intelligence does not support any claims of a deliberate attack against the energy infrastructure on, or leading up to, August 14, 2003. The few instances of physical damage that occurred on power delivery lines were the result of natural events and not of sabotage. No intelligence reports prior to, during or after the power outage indicated any specific terrorist plans or operations against the energy infrastructure. No incident reports detail suspicious activity near the power generation plants or delivery lines in question.

3. Physical Analysis

The Physical Analysis sub-team was led by the United States Secret Service and the RCMP. These organizations have a particular expertise in physical security assessments in the energy sector. The sub-team focused on issues related to how the cyber-related facilities of the energy sector companies were secured, including the physical integrity of data centers and control rooms along with security procedures and policies used to limit access to sensitive areas. Focusing on the facilities identified as having a causal relationship to the outage,

the sub-team sought to determine if the physical integrity of these cyber facilities was breached, whether externally or by an insider, prior to or during the outage, and if so, whether such a breach caused or contributed to the power outage.

Although the sub-team analyzed information provided to both the ESWG and Nuclear Working Groups, the Physical Analysis sub-team also reviewed information resulting from face-to-face meetings with energy sector personnel and site-visits to energy sector facilities to determine the physical integrity of the cyber infrastructure.

The sub-team compiled a list of questions covering location, accessibility, cameras, alarms, locks, fire protection and water systems as they apply to computer server rooms. Based on discussions of these questions during its interviews, the sub-team found no evidence that the physical integrity of the cyber infrastructure was breached. Additionally, the sub-team examined access and control measures used to allow entry into command and control facilities and the integrity of remote facilities.

The sub-team also concentrated on mechanisms used by the companies to report unusual incidents within server rooms, command and control rooms and remote facilities. The sub-team also addressed the possibility of an insider attack on the cyber infrastructure.

4. Policies and Procedures

The Policies and Procedures sub-team was led by DHS and Public Safety and Emergency Preparedness Canada. Personnel from these organizations have strong backgrounds in the fields of electric delivery operations, automated control systems including SCADA and EMS, and information security.

This sub-team was focused on examining the overall policies and procedures that may or may not have been in place during the events leading up to and during the power outage of August 14, 2003. Policies that the team examined revolved centrally around the cyber systems of the companies identified in the early stages of the power outage. Of specific interest to the team were policies and procedures regarding the upgrade and maintenance (to include system patching) of the command and control (C2) systems, including SCADA and EMS. The Policies and Procedures sub-team was also interested in the procedures for contingency operations and restoration of systems in the

event of a computer system failure, or a cyber event such as an active hack or the discovery of malicious code.

5. Supporting Infrastructure

The Supporting Infrastructure sub-team was led by a DHS expert with experience assessing supporting infrastructure elements such as water cooling for computer systems, back-up power systems, heating, ventilation and air conditioning (HVAC), and supporting telecommunications networks. Public Safety and Emergency Preparedness Canada was the Canadian co-lead for this effort. This team analyzed the integrity of the supporting infrastructure and its role, if any, in the power outage on August 14, 2003. It sought to determine whether the supporting infrastructure was performing at a satisfactory level leading up to and during the power outage of August 14, 2003. In addition, the team verified with vendors if there were maintenance issues that may have impacted operations prior to and during the outage.

The sub-team specifically focused on the following key issues in visits to each of the designated electrical entities:

1. Carrier/provider/vendor for the supporting infrastructure services and/or systems at select company facilities;
2. Loss of service before and/or after the power outage;
3. Conduct of maintenance activities before and/or after the power outage;
4. Conduct of installation activities before and/or after the power outage;
5. Conduct of testing activities before and/or after the power outage;
6. Conduct of exercises before and/or after the power outage; and
7. Existence of a monitoring process (log, checklist etc.) to document the status of supporting infrastructure services.

6. Root Cause Analysis

The SWG Root Cause Liaison Sub-Team (SWG/RC) followed the work of the ESWG to identify potential root causes of the power outage. As these root cause elements were identified, the sub-team assessed with the ESWG any potential linkages to physical and/or cyber malfeasance. The final analysis of the SWG/RC team found no causal link

between the power outage and malicious activity, whether physical or cyber initiated.

Cyber Timeline

The following sequence of events was derived from discussions with representatives of FirstEnergy and the Midwest Independent System Operator (MISO). All times are approximate.

The first significant cyber-related event of August 14, 2003, occurred at 12:40 EDT at the MISO. At this time, a MISO EMS engineer purposely disabled the automatic periodic trigger on the State Estimator (SE) application, an application that allows MISO to determine the real-time state of the power system for its region. The disablement of the automatic periodic trigger, a program feature that causes the SE to run automatically every five minutes, is a necessary operating procedure when resolving a mismatched solution produced by the SE. The EMS engineer determined that the mismatch in the SE solution was due to the SE model depicting Cinergy's Bloomington-Denois Creek 230-kV line as being in service, when it had actually been out of service since 12:12 EDT.

At 13:00 EDT, after making the appropriate changes to the SE model and manually triggering the SE, the MISO EMS engineer achieved two valid solutions.

At 13:30 EDT, the MISO EMS engineer went to lunch. However, he forgot to re-engage the automatic periodic trigger.

At 14:14 EDT, FirstEnergy's "Alarm and Event Processing Routine," (AEPR) a key software program that gives grid operators visual and audible indications of events occurring on their portion of the grid, began to malfunction. FirstEnergy grid operators were unaware that the software was not functioning properly. This software did not become functional again until much later that evening.

At 14:40 EDT, an Ops Engineer discovered the SE was not solving and went to notify an EMS engineer that the SE was not solving.

At 14:41 EDT, FirstEnergy's server running the AEPR software failed to the backup server. Control room staff remained unaware that the AEPR software was not functioning properly.

At 14:44 EDT, a MISO EMS engineer, after being alerted by the Ops Engineer, re-activated the automatic periodic trigger and, for speed, manually triggered the program. However, the SE program again showed a mismatch.

At 14:54 EDT, FirstEnergy’s backup server failed. AEPR continued to malfunction. The Area Control Error Calculations (ACE) and Strip Charting routines malfunctioned and the dispatcher user interface slowed significantly.

At 15:00 EDT, FirstEnergy used its emergency backup system to control the system and make ACE calculations. ACE calculations and control systems continued to run on the emergency backup system until roughly 15:08 EDT, when the primary server was restored.

At 15:05 EDT, FirstEnergy’s Harding-Chamberlin 345-kV line tripped and locked out. FirstEnergy grid operators did not receive notification from the AEPR software which continued to malfunction, unbeknownst to the FirstEnergy grid operators.

At 15:08 EDT, using data obtained at roughly 15:04 EDT (it takes roughly five minutes for the SE to provide a result), the MISO EMS engineer concluded that the SE mismatched due to a line outage. His experience allowed him to isolate the outage to the Stuart-Atlanta 345-kV line (which tripped about an hour earlier at 14:02 EDT). He took the Stuart-Atlanta line out of service in the SE model and got a valid solution.

Also at 15:08 EDT, the FirstEnergy primary server was restored. ACE calculations and control systems were now running on the primary server. AEPR continued to malfunction, unbeknownst to the FirstEnergy grid operators.

At 15:09 EDT, the MISO EMS engineer went to the control room to tell the grid operators that he

thought the Stuart-Atlanta line was out of service. Grid operators referred to their “Outage Scheduler” and informed the EMS Engineer that their data showed the Stuart-Atlanta line was “up” and that the EMS engineer should depict the line as in service in the SE model. At 15:17 EDT, the EMS engineer ran the SE with the Stuart-Atlanta line “live,” but the model again mismatched.

At 15:29 EDT, the MISO EMS Engineer asked MISO grid operators to call PJM Interconnect, LLC to determine the status of the Stuart-Atlanta line. MISO was informed that the Stuart-Atlanta line tripped at 14:02 EDT. The EMS Engineer adjusted the model, which by this time had been updated with the 15:05 EDT Harding-Chamberlin 345-kV line trip, and came up with a valid solution.

At 15:32 EDT, FirstEnergy’s Hanna-Juniper 345-kV line tripped and locked out. The AEPR continued to malfunction.

At 15:41 EDT, the lights flickered at the FirstEnergy’s control facility. This occurred because they had lost grid power and switched over to their emergency power supply.

At 15:42 EDT, a FirstEnergy dispatcher realized that the AEPR was not working and made technical support staff aware of the problem.

Endnotes

¹ <http://www.nrc.gov/reading-rm/doc-collections/news/2003/03-108.html>.

² <http://www.fbi.gov/congress/congress03/mefford090403.htm>.

³ <http://www.fbi.gov/congress/congress03/mefford090403.htm>.

10. Recommendations to Prevent or Minimize the Scope of Future Blackouts

Introduction

As reported in previous chapters, the blackout on August 14, 2003, was preventable. It had several direct causes and contributing factors, including:

- ◆ Failure to maintain adequate reactive power support
- ◆ Failure to ensure operation within secure limits
- ◆ Inadequate vegetation management
- ◆ Inadequate operator training
- ◆ Failure to identify emergency conditions and communicate that status to neighboring systems
- ◆ Inadequate regional-scale visibility over the bulk power system.

Further, as discussed in Chapter 7, after each major blackout in North America since 1965, an expert team of investigators has probed the causes of the blackout, written detailed technical reports, and issued lists of recommendations to prevent or minimize the scope of future blackouts. Yet several of the causes of the August 14 blackout are strikingly similar to those of the earlier blackouts. Clearly, efforts to implement earlier recommendations have not been adequate.¹ Accordingly, the recommendations presented below emphasize comprehensiveness, monitoring, training, and enforcement of reliability standards when necessary to ensure compliance.

It is useful to think of the recommendations presented below in terms of four broad themes:

1. Government bodies in the U.S. and Canada, regulators, the North American electricity industry, and related organizations should commit themselves to making adherence to high reliability standards paramount in the planning, design, and operation of North America's vast

bulk power systems. Market mechanisms should be used where possible, but in circumstances where conflicts between reliability and commercial objectives cannot be reconciled, they must be resolved in favor of high reliability.²

2. Regulators and consumers should recognize that reliability is not free, and that maintaining it requires ongoing investments and operational expenditures by many parties. Regulated companies will not make such outlays without assurances from regulators that the costs will be recoverable through approved electric rates, and unregulated companies will not make such outlays unless they believe their actions will be profitable.³
3. Recommendations have no value unless they are implemented. Accordingly, the Task Force emphasizes strongly that North American governments and industry should commit themselves to working together to put into effect the suite of improvements mapped out below. Success in this area will require particular attention to the mechanisms proposed for performance monitoring, accountability of senior management, and enforcement of compliance with standards.
4. The bulk power systems are among the most critical elements of our economic and social infrastructure. Although the August 14 blackout was not caused by malicious acts, a number of security-related actions are needed to enhance reliability.

Over the past decade or more, electricity demand has increased and the North American interconnections have become more densely woven and heavily loaded, over more hours of the day and year. In many geographic areas, the number of single or multiple contingencies that could create serious problems has increased. Operating the

grids at higher loadings means greater stress on equipment and a smaller range of options and a shorter period of time for dealing with unexpected problems. The system operator's job has become more challenging, leading to the need for more sophisticated grid management tools and more demanding operator training programs and certification requirements.

The recommendations below focus on changes of many kinds that are needed to ensure reliability, for both the summer of 2004 and for the years to follow. Making these changes will require higher and broader awareness of the importance of reliability, and some of them may require substantial new investments. However, the cost of *not* making these changes, i.e., the cost of chronic large-scale blackouts, would be far higher than the cost of addressing the problem. Estimates of the cost of the August 14 blackout range between \$4 and \$10 billion (U.S.).⁴

The need for additional attention to reliability is not necessarily at odds with increasing competition and the improved economic efficiency it brings to bulk power markets. Reliability and economic efficiency can be compatible, but this outcome requires more than reliance on the laws of physics and the principles of economics. It requires sustained, focused efforts by regulators, policy makers, and industry leaders to strengthen and maintain the institutions and rules needed to protect both of these important goals. Regulators must ensure that competition does not erode incentives to comply with reliability requirements, and that reliability requirements do not serve as a smokescreen for noncompetitive practices.

The metric for gauging achievement of this goal—making the changes needed to maintain a high level of reliability for the next decade or longer—will be the degree of compliance obtained with the recommendations presented below. The single most important step in the United States is for the U.S. Congress to enact the reliability provisions in pending energy bills (H.R. 6 and S. 2095). If that can be done, many of the actions recommended below could be accomplished readily in the course of implementing the legislation.

Some commenters asserted that the Interim Report did not analyze all factors they believe may have contributed to the August 14 blackout.

Implementation of the recommendations presented below will address all remaining issues, through the ongoing work of government bodies and agencies in the U.S. and Canada, the electric-utility industry, and the non-governmental institutions responsible for the maintenance of electric reliability in North America.

Recommendations

Forty-six numbered recommendations are presented below, grouped into four substantive areas. Some recommendations concern subjects that were addressed in some detail by commenters on the Interim Report or participants in the Task Force's two technical conferences. In such cases, the commenters are listed in the Endnotes section of this chapter. Citation in the endnotes does not necessarily mean that the commenter supports the position expressed in the recommendation. A "table of contents" overview of the recommendations is provided in the text box on pages 141-142.

Group I. Institutional Issues Related to Reliability

1. Make reliability standards mandatory and enforceable, with penalties for non-compliance.⁵

Appropriate branches of government in the United States and Canada should take action as required to make reliability standards mandatory and enforceable, and to provide appropriate penalties for noncompliance.

A. Action by the U.S. Congress

The U.S. Congress should enact reliability legislation no less stringent than the provisions now included in the pending comprehensive energy bills, H.R. 6 and S. 2095. Specifically, these provisions would require that:

- ◆ Reliability standards are to be mandatory and enforceable, with penalties for noncompliance.
- ◆ Reliability standards should be developed by an independent, international electric reliability organization (ERO) with fair stakeholder representation in the selection of its directors and balanced decision-making in any ERO committee or subordinate organizational structure. (See text box on NERC and an ERO below.)

Overview of Task Force Recommendations: Titles Only

Group I. Institutional Issues Related to Reliability

1. Make reliability standards mandatory and enforceable, with penalties for noncompliance.
2. Develop a regulator-approved funding mechanism for NERC and the regional reliability councils, to ensure their independence from the parties they oversee.
3. Strengthen the institutional framework for reliability management in North America.
4. Clarify that prudent expenditures and investments for bulk system reliability (including investments in new technologies) will be recoverable through transmission rates.
5. Track implementation of recommended actions to improve reliability.
6. FERC should not approve the operation of new RTOs or ISOs until they have met minimum functional requirements.
7. Require any entity operating as part of the bulk power system to be a member of a regional reliability council if it operates within the council's footprint.
8. Shield operators who initiate load shedding pursuant to approved guidelines from liability or retaliation.
9. Integrate a "reliability impact" consideration into the regulatory decision-making process.
10. Establish an independent source of reliability performance information.
11. Establish requirements for collection and reporting of data needed for post-blackout analyses.
12. Commission an independent study of the relationships among industry restructuring, competition, and reliability.
13. DOE should expand its research programs on reliability-related tools and technologies.
14. Establish a standing framework for the conduct of future blackout and disturbance investigations.

Group II. Support and Strengthen NERC's Actions of February 10, 2004

15. Correct the direct causes of the August 14, 2003 blackout.
16. Establish enforceable standards for maintenance of electrical clearances in right-of-way areas.
17. Strengthen the NERC Compliance Enforcement Program.
18. Support and strengthen NERC's Reliability Readiness Audit Program.
19. Improve near-term and long-term training and certification requirements for operators, reliability coordinators, and operator support staff.
20. Establish clear definitions for *normal*, *alert* and *emergency* operational system conditions. Clarify roles, responsibilities, and authorities of reliability coordinators and control areas under each condition.
21. Make more effective and wider use of system protection measures.
22. Evaluate and adopt better real-time tools for operators and reliability coordinators.
23. Strengthen reactive power and voltage control practices in all NERC regions.
24. Improve quality of system modeling data and data exchange practices.
25. NERC should reevaluate its existing reliability standards development process and accelerate the adoption of enforceable standards.
26. Tighten communications protocols, especially for communications during alerts and emergencies. Upgrade communication system hardware where appropriate.
27. Develop enforceable standards for transmission line ratings.
28. Require use of time-synchronized data recorders.
29. Evaluate and disseminate lessons learned during system restoration.
30. Clarify criteria for identification of operationally critical facilities, and improve dissemination of updated information on unplanned outages.
31. Clarify that the transmission loading relief (TLR) process should not be used in situations involving an actual violation of an Operating Security Limit. Streamline the TLR process.

(continued on page 142)

Overview of Task Force Recommendations: Titles Only (Continued)

Group III. Physical and Cyber Security of North American Bulk Power Systems

32. Implement NERC IT standards.
33. Develop and deploy IT management procedures.
34. Develop corporate-level IT security governance and strategies.
35. Implement controls to manage system health, network monitoring, and incident management.
36. Initiate U.S.-Canada risk management study.
37. Improve IT forensic and diagnostic capabilities.
38. Assess IT risk and vulnerability at scheduled intervals.
39. Develop capability to detect wireless and remote wireline intrusion and surveillance.
40. Control access to operationally sensitive equipment.
41. NERC should provide guidance on employee background checks.
42. Confirm NERC ES-ISAC as the central point for sharing security information and analysis.
43. Establish clear authority for physical and cyber security.
44. Develop procedures to prevent or mitigate inappropriate disclosure of information.

Group IV. Canadian Nuclear Power Sector

45. The Task Force recommends that the Canadian Nuclear Safety Commission request Ontario Power Generation and Bruce Power to review operating procedures and operator training associated with the use of adjuster rods.
46. The Task Force recommends that the Canadian Nuclear Safety Commission purchase and install backup generation equipment.

- ◆ Reliability standards should allow, where appropriate, flexibility to accommodate regional differences, including more stringent reliability requirements in some areas, but regional deviations should not be allowed to lead to lower reliability expectations or performance.
- ◆ An ERO-proposed standard or modification to a standard should take effect within the United States upon approval by the Federal Energy Regulatory Commission (FERC).
- ◆ FERC should remand to the ERO for further consideration a proposed reliability standard or a modification to a reliability standard that it disapproves of in whole or in part, with explanation for its concerns and rationale.

B. Action by FERC

In the absence of such reliability legislation, FERC should review its statutory authorities under existing law, and to the maximum extent permitted by those authorities, act to enhance reliability by making compliance with reliability standards enforceable in the United States. In doing so, FERC should consult with state regulators, NERC, and the regional reliability councils to determine whether certain enforcement practices now in use in some parts of the U.S. and Canada might be

applied more broadly. For example, in the Western U.S. and Canada, many members of the Western Electricity Coordinating Council (WECC) include clauses in contracts for the purchase of wholesale power that require the parties to comply with reliability standards. In the areas of the U.S. and Canada covered by the Northeast Power Coordinating Council (NPCC), parties found not to be in compliance with NERC and NPCC reliability requirements are subject to escalating degrees of scrutiny by their peers and the public. Both of these approaches have had positive effects. FERC should examine other approaches as well, and work with state regulatory authorities to ensure

NERC and the ERO

If the proposed U.S. reliability legislation passes, the North American Electric Reliability Council (NERC) may undertake various organizational changes and seek recognition as the electric reliability organization (ERO) called for in H.R. 6 and S. 2095. For simplicity of presentation, the many forward-looking references below to “NERC” are intended to apply to the ERO if the legislation is passed, and to NERC if the legislation is not passed.

that any other appropriate actions to make reliability standards enforceable are taken.

Action by FERC under its existing authorities would not lessen the need for enactment of reliability legislation by the Congress. Many U.S. parties that should be required by law to comply with reliability requirements are not subject to the Commission's full authorities under the Federal Power Act.

C. Action by Appropriate Authorities in Canada

The interconnected nature of the transmission grid requires that reliability standards be identical or compatible on both sides of the Canadian/U.S. border. Several provincial governments in Canada have already demonstrated support for mandatory and enforceable reliability standards and have either passed legislation or have taken steps to put in place the necessary framework for implementing such standards in Canada. The federal and provincial governments should work together and with appropriate U.S. authorities to complete a framework to ensure that identical or compatible standards apply in both countries, and that means are in place to enforce them in all interconnected jurisdictions.

D. Joint Actions by U.S. and Canadian Governments

International coordination mechanisms should be developed between the governments in Canada and the United States to provide for government oversight of NERC or the ERO, and approval and enforcement of reliability standards.

E. Memoranda of Understanding between U.S. or Canadian Government Agencies and NERC

Government agencies in both countries should decide (individually) whether to develop a memorandum of understanding (MOU) with NERC that would define the agency's working relationship with NERC, government oversight of NERC activities if appropriate, and the reliability responsibilities of the signatories.

2. Develop a regulator-approved mechanism for funding NERC and the regional reliability councils, to ensure their independence from the parties they oversee.⁶

U.S. and Canadian regulatory authorities should work with NERC, the regional councils, and the industry to develop and implement a new funding mechanism for NERC and the regional councils

based on a surcharge in transmission rates. The purpose would be to ensure that NERC and the councils are appropriately funded to meet their changing responsibilities without dependence on the parties that they oversee. Note: Implementation of this recommendation should be coordinated with the review called for in Recommendation 3 concerning the future role of the regional councils.

NERC's current \$13 million/year budget is funded as part of the dues that transmission owners, generators, and other market participants pay to the ten regional reliability councils, which then fund NERC. This arrangement makes NERC subject to the influence of the reliability councils, which are in turn subject to the influence of their control areas and other members. It also compromises the independence of both NERC and the councils in relation to the entities whose actions they oversee, and makes it difficult for them to act forcefully and objectively to maintain the reliability of the North American bulk power system. Funding NERC and the councils through a transmission rate surcharge administered and disbursed under regulatory supervision would enable the organizations to be more independent of the industry, with little impact on electric bills. The dues that companies pay to the regional councils are passed through to electricity customers today, so the net impacts on customer bills from shifting to a rate surcharge would be minimal.

Implementation of the recommendations presented in this report will involve a substantial increase in NERC's functions and responsibilities, and require an increase in NERC's annual budget. The additional costs, however, would be small in comparison to the cost of a single major blackout.

3. Strengthen the institutional framework for reliability management in North America.⁷

FERC, DOE and appropriate authorities in Canada should work with the states, NERC, and the industry, to evaluate and develop appropriate modifications to the existing institutional framework for reliability management. In particular, the affected government agencies should:

- A. Commission an independent review by qualified experts in organizational design and management to address issues concerning how best to structure an international reliability organization for the long term.**

- B. Based in part on the results of that review, develop metrics for gauging the adequacy of NERC's performance, and specify the functions of the NERC Board of Trustees and the procedure for selecting the members of the Board.**
- C. Examine and clarify the future role of the regional reliability councils, with particular attention to their mandate, scope, structure, responsibilities, and resource requirements.**
- D. Examine NERC's proposed Functional Model and set minimum requirements under which NERC would certify applicants' qualifications to perform critical functions.**
- E. Request NERC and the regional councils to suspend designation of any new control areas (or sub-control areas) until the minimum requirements in section D (above) have been established, unless an applicant shows that such designation would significantly enhance reliability.**
- F. Determine ways to enhance reliability operations in the United States through simplified organizational boundaries and resolution of seams issues.**

A and B. Reshaping NERC

The far-reaching organizational changes in the North American electricity industry over the past decade have already induced major changes in the nature of NERC as an organization. However, the process of change at NERC is far from complete. Important additional changes are needed such as the shift to enforceable standards, development of an effective monitoring capability, and funding that is not dependent on the industry. These changes will strengthen NERC as an organization. In turn, to properly serve overarching public policy concerns, this strengthening of NERC's capabilities will have to be balanced with increased government oversight, more specific metrics for gauging NERC's performance as an organization, and greater transparency concerning the functions of its senior management team (including its Board of Trustees) and the procedures by which those individuals are selected. The affected government agencies should jointly commission an independent review of these and related issues to aid them in making their respective decisions.

C. The Role of the Regional Reliability Councils

North America's regional reliability councils have evolved into a disparate group of organizations with varying responsibilities, expertise, roles,

sizes and resources. Some have grown from a reliability council into an ISO or RTO (ERCOT and SPP), some span less than a single state (FRCC and ERCOT) while others cover many states and provinces and cross national boundaries (NPCC and WECC). Several cross reliability coordinator boundaries. It is time to evaluate the appropriate size and scope of a regional council, the specific tasks that it should perform, and the appropriate level of resources, expertise, and independence that a regional reliability council needs to perform those tasks effectively. This evaluation should also address whether the councils as currently constituted are appropriate to meet future reliability needs.

D. NERC's Functional Model

The transition to competition in wholesale power markets has been accompanied by increasing diversity in the kinds of entities that need to be in compliance with reliability standards. Rather than resist or attempt to influence this evolution, NERC's response—through the Functional Model—has been to seek a means of enabling reliability to be maintained under virtually any institutional framework. The Functional Model identifies sixteen basic functions associated with operating the bulk electric systems and maintaining reliability, and the capabilities that an organization must have in order to perform a given function. (See Functional Model text box below.)

NERC acknowledges that maintaining reliability in some frameworks may be more difficult or more expensive than in others, but it stresses that as long as some responsible party addresses each function and the rules are followed, reliability will be preserved. By implication, the pros and cons of alternative institutional frameworks in a given region—which may affect aspects of electric industry operations other than reliability—are matters for government agencies to address, not NERC.

One of the major purposes of the Functional Model is to create a vehicle through which NERC will be able to identify an entity responsible for performing each function in every part of the three North American interconnections. NERC considers four of the sixteen functions to be especially critical for reliability. For these functions, NERC intends, upon application by an entity, to review the entity's capabilities, and if appropriate, certify that the entity has the qualifications to perform that function within the specified geographic area. For the other twelve functions, NERC proposes to

“register” entities as responsible for a given function in a given area, upon application.

All sixteen functions are presently being performed to varying degrees by one entity or another today in all areas of North America. Frequently an entity performs a combination of functions, but there is great variety from one region to another in how the functions are bundled and carried out. Whether all of the parties who are presently performing the four critical functions would meet NERC’s requirements for certification is not known, but the proposed process provides a means of identifying any weaknesses that need to be rectified.

At present, after protracted debate, the Functional Model appears to have gained widespread but cautious support from the diverse factions across the industry, while the regulators have not taken a position. In some parts of North America, such as the Northeast, large regional organizations will probably be certified to perform all four of the

Sixteen Functions in NERC’s Functional Model

- ◆ **Operating Reliability**
- ◆ **Planning Reliability**
- ◆ **Balancing** (generation and demand)
- ◆ **Interchange**
- ◆ Transmission service
- ◆ Transmission ownership
- ◆ Transmission operations
- ◆ Transmission planning
- ◆ Resource planning
- ◆ Distribution
- ◆ Generator ownership
- ◆ Generator operations
- ◆ Load serving
- ◆ Purchasing and selling
- ◆ Standards development
- ◆ Compliance monitoring

NERC regards the four functions shown above in bold as especially critical to reliability. Accordingly, it proposes to certify applicants that can demonstrate that they have the capabilities required to perform those functions. The Operating Reliability authority would correspond to today’s reliability coordinator, and the Balancing authority to today’s control area operator.

critical functions for their respective areas. In other areas, capabilities may remain less aggregated, and the institutional structure may remain more complex.

Working with NERC and the industry, FERC and authorities in Canada should review the Functional Model to ensure that operating hierarchies and entities will facilitate, rather than hinder, efficient reliability operations. At a minimum, the review should identify ways to eliminate inappropriate commercial incentives to retain control area status that do not support reliability objectives; address operational problems associated with institutional fragmentation; and set minimum requirements with respect to the capabilities requiring NERC certification, concerning subjects such as:

1. Fully operational backup control rooms.
2. System-wide (or wider) electronic map boards or functional equivalents, with data feeds that are independent of the area’s main energy management system (EMS).
3. Real-time tools that are to be available to the operator, with backups. (See Recommendation 22 below for more detail concerning minimum requirements and guidelines for real-time operating tools.)
4. SCADA and EMS requirements, including backup capabilities.
5. Training programs for all personnel who have access to a control room or supervisory responsibilities for control room operations. (See Recommendation 19 for more detail on the Task Force’s views regarding training and certification requirements.)
6. Certification requirements for control room managers and staff.

E. Designation of New Control Areas

Significant changes in the minimum functional requirements for control areas (or balancing authorities, in the context of the Functional Model) may result from the review called for above. Accordingly, the Task Force recommends that regulatory authorities should request NERC and the regional councils not to certify any new control areas (or sub-control areas) until the appropriate regulatory bodies have approved the minimum functional requirements for such bodies, unless an applicant shows that such designation would significantly enhance reliability.

F. Boundary and Seam Issues and Minimum Functional Requirements

Some observers believe that some U.S. regions have too many control areas performing one or more of the four critical reliability functions. In many cases, these entities exist to retain commercial advantages associated with some of these functions. The resulting institutional fragmentation and decentralization of control leads to a higher number of operating contacts and seams, complex coordination requirements, misalignment of control areas with other electrical boundaries and/or operating hierarchies, inconsistent practices and tools, and increased compliance monitoring requirements. These consequences hamper the efficiency and reliability of grid operations.

As shown above (text box on page 14), MISO, as reliability coordinator for its region, is responsible for dealing with 37 control areas, whereas PJM now spans 9 control areas, ISO-New England has 2, and the New York ISO, Ontario's IMO, Texas' ERCOT, and Québec's Trans-Energie are themselves the control area operators for their respective large areas. Moreover, it is not clear that small control areas are financially able to provide the facilities and services needed to perform control area functions at the level needed to maintain reliability. This concern applies also to the four types of entities that NERC proposes to certify under the Functional Model (i.e., Reliability Authority, Planning Authority, Balancing Authority, and Interchange Authority).

For the long term, the regulatory agencies should continue to seek ways to ensure that the regional operational frameworks that emerge through the implementation of the Functional Model promote reliable operations. Any operational framework will represent some combination of tradeoffs, but reliability is a critically important public policy objective and should be a primary design criterion.

4. Clarify that prudent expenditures and investments for bulk system reliability (including investments in new technologies) will be recoverable through transmission rates.⁸

FERC and appropriate authorities in Canada should clarify that prudent expenditures and investments by regulated companies to maintain or improve bulk system reliability will be recoverable through transmission rates.

In the U.S., FERC and DOE should work with state regulators to identify and resolve issues related to the recovery of reliability costs and investments through retail rates. Appropriate authorities in Canada should determine whether similar efforts are warranted.

Companies will not make the expenditures and investments required to maintain or improve the reliability of the bulk power system without credible assurances that they will be able to recover their costs.

5. Track implementation of recommended actions to improve reliability.⁹

In the requirements issued on February 10, 2004, NERC announced that it and the regional councils would establish a program for documenting completion of recommendations resulting from the August 14 blackout and other historical outages, as well as NERC and regional reports on violations of reliability standards, results of compliance audits, and lessons learned from system disturbances. The regions are to report on a quarterly basis to NERC.

In addition, NERC intends to initiate by January 1, 2005 a reliability performance monitoring function that will evaluate and report on trends in bulk electric system reliability performance.

The Task Force supports these actions strongly. However, many of the Task Force's recommendations pertain to government bodies as well as NERC. Accordingly:

A. Relevant agencies in the U.S. and Canada should cooperate to establish mechanisms for tracking and reporting to the public on implementation actions in their respective areas of responsibility.

B. NERC should draw on the above-mentioned quarterly reports from its regional councils to prepare annual reports to FERC, appropriate authorities in Canada, and the public on the status of the industry's compliance with recommendations and important trends in electric system reliability performance.

The August 14 blackout shared a number of contributing factors with prior large-scale blackouts,

confirming that the lessons and recommendations from earlier blackouts had not been adequately implemented, at least in some geographic areas. Accordingly, parallel and coordinated efforts are needed by the relevant government agencies and NERC to track the implementation of recommendations by governments and the electricity industry. WECC and NPCC have already established programs that could serve as models for tracking implementation of recommendations.

6. FERC should not approve the operation of a new RTO or ISO until the applicant has met the minimum functional requirements for reliability coordinators.

The events of August 14 confirmed that MISO did not yet have all of the functional capabilities required to fulfill its responsibilities as reliability coordinator for the large area within its footprint. FERC should not authorize a new RTO or ISO to become operational until the RTO or ISO has verified that all critical reliability capabilities will be functional upon commencement of RTO or ISO operations.

7. Require any entity operating as part of the bulk power system to be a member of a regional reliability council if it operates within the council's footprint.¹⁰

The Task Force recommends that FERC and appropriate authorities in Canada be empowered through legislation, if necessary, to require all entities that operate as part of the bulk electric system to certify that they are members of the regional reliability council for all NERC regions in which they operate.

This requirement is needed to ensure that all relevant parties are subject to NERC standards, policies, etc., in all NERC regions in which they operate. Action by the Congress or legislative bodies in Canada may be necessary to provide appropriate authority.

8. Shield operators who initiate load shedding pursuant to approved guidelines from liability or retaliation.¹¹

Legislative bodies and regulators should: 1) establish that operators (whether organizations or individuals) who initiate load shedding pursuant to operational guidelines are not subject to liability

suits; and 2) affirm publicly that actions to shed load pursuant to such guidelines are not indicative of operator failure.

Timely and sufficient action to shed load on August 14 would have prevented the spread of the blackout beyond northern Ohio. NERC has directed all the regional councils in all areas of North America to review the applicability of plans for under-voltage load shedding, and to support the development of such capabilities where they would be beneficial. However, organizations and individual operators may hesitate to initiate such actions in appropriate circumstances without assurances that they will not be subject to liability suits or other forms of retaliation, provided their action is pursuant to previously approved guidelines.

9. Integrate a "reliability impact" consideration into the regulatory decision-making process.¹²

The Task Force recommends that FERC, appropriate authorities in Canada, and state regulators integrate a formal reliability impact consideration into their regulatory decision-making to ensure that their actions or initiatives either improve or at minimum do no harm to reliability.

Regulatory actions can have unintended consequences. For example, in reviewing proposed utility company mergers, FERC's primary focus has been on financial and rate issues, as opposed to the reliability implications of such mergers. To minimize unintended harm to reliability, and aid the improvement of reliability where appropriate, the Task Force recommends that regulators incorporate a formal reliability impact consideration into their decision processes. At the same time, regulators should be watchful for use of alleged reliability impacts as a smokescreen for anti-competitive or discriminatory behavior.

10. Establish an independent source of reliability performance information.¹³

The U.S. Department of Energy's Energy Information Administration (EIA), in coordination with other interested agencies and data sources (FERC, appropriate Canadian government agencies, NERC, RTOs, ISOs, the regional councils, transmission operators, and generators) should establish common definitions and information collection standards. If the necessary resources can be identified, EIA should expand its current activities to include information on reliability performance.

Energy policy makers and a wide range of economic decision makers need objective, factual information about basic trends in reliability performance. EIA and the other organizations cited above should identify information gaps in federal data collections covering reliability performance and physical characteristics. Plans to fill those gaps should be developed, and the associated resource requirements determined. Once those resources have been acquired, EIA should publish information on trends, patterns, costs, etc. related to reliability performance.

11. Establish requirements for collection and reporting of data needed for post-blackout analyses.

FERC and appropriate authorities in Canada should require generators, transmission owners, and other relevant entities to collect and report data that may be needed for analysis of blackouts and other grid-related disturbances.

The investigation team found that some of the data needed to analyze the August 14 blackout fully was not collected at the time of the events, and thus could not be reported. Some of the data that was reported was based on incompatible definitions and formats. As a result, there are aspects of the blackout, particularly concerning the evolution of the cascade, that may never be fully explained. FERC, EIA and appropriate authorities in Canada should consult with NERC, key members of the investigation team, and the industry to identify information gaps, adopt common definitions, and establish filing requirements.

12. Commission an independent study of the relationships among industry restructuring, competition, and reliability.¹⁴

DOE and Natural Resources Canada should commission an independent study of the relationships among industry restructuring, competition in power markets, and grid reliability, and how those relationships should be managed to best serve the public interest.

Some participants at the public meetings held in Cleveland, New York and Toronto to review the Task Force's Interim Report expressed the view that the restructuring of electricity markets for competition in many jurisdictions has, itself, increased the likelihood of major supply interruptions. Some of these commenters assert that the

transmission system is now being used to transmit power over distances and at volumes that were not envisioned when the system was designed, and that this functional shift has created major risks that have not been adequately addressed. Indeed, some commenters believe that restructuring was a major cause of the August 14 blackout.

The Task Force believes that the Interim Report accurately identified the primary causes of the blackout. It also believes that had existing reliability requirements been followed, either the disturbance in northern Ohio that evolved on August 14 into a blackout would not have occurred, or it would have been contained within the FE control area.

Nevertheless, as discussed at the beginning of this chapter, the relationship between competition in power markets and reliability is both important and complex, and careful management and sound rules are required to achieve the public policy goals of reasonable electricity prices and high reliability. At the present stage in the evolution of these markets, it is worthwhile for DOE and Natural Resources Canada (in consultation with FERC and the Canadian Council of Energy Ministers) to commission an independent expert study to provide advice on how to achieve and sustain an appropriate balance in this important area.

Among other things, this study should take into account factors such as:

- ◆ Historical and projected load growth
- ◆ Location of new generation in relation to old generation and loads
- ◆ Zoning and NIMBY¹⁵ constraints on siting of generation and transmission
- ◆ Lack of new transmission investment and its causes
- ◆ Regional comparisons of impact of wholesale electric competition on reliability performance and on investments in reliability and transmission
- ◆ The financial community's preferences and their effects on capital investment patterns
- ◆ Federal vs. state jurisdictional concerns
- ◆ Impacts of state caps on retail electric rates
- ◆ Impacts of limited transmission infrastructure on energy costs, transmission congestion, and reliability

- ◆ Trends in generator fuel and wholesale electricity prices
- ◆ Trends in power flows, line losses, voltage levels, etc.

13. DOE should expand its research programs on reliability-related tools and technologies.¹⁶

DOE should expand its research agenda, and consult frequently with Congress, FERC, NERC, state regulators, Canadian authorities, universities, and the industry in planning and executing this agenda.

More investment in research is needed to improve grid reliability, with particular attention to improving the capabilities and tools for system monitoring and management. Research on reliability issues and reliability-related technologies has a large public-interest component, and government support is crucial. DOE already leads many research projects in this area, through partnerships with industry and research under way at the national laboratories and universities. DOE's leadership and frequent consultation with many parties are essential to ensure the allocation of scarce research funds to urgent projects, bring the best talent to bear on such projects, and enhance the dissemination and timely application of research results.

Important areas for reliability research include but are not limited to:

- ◆ Development of practical real-time applications for wide-area system monitoring using phasor measurements and other synchronized measuring devices, including post-disturbance applications.
- ◆ Development and use of enhanced techniques for modeling and simulation of contingencies, blackouts, and other grid-related disturbances.
- ◆ Investigation of protection and control alternatives to slow or stop the spread of a cascading power outage, including demand response initiatives to slow or halt voltage collapse.
- ◆ Re-evaluation of generator and customer equipment protection requirements based on voltage and frequency phenomena experienced during the August 14, 2003, cascade.
- ◆ Investigation of protection and control of generating units, including the possibility of multiple steps of over-frequency protection and possible

effects on system stability during major disturbances.

- ◆ Development of practical human factors guidelines for power system control centers.
- ◆ Study of obstacles to the economic deployment of demand response capability and distributed generation.
- ◆ Investigation of alternative approaches to monitoring right-of-way vegetation management.
- ◆ Study of air traffic control, the airline industry, and other relevant industries for practices and ideas that could reduce the vulnerability of the electricity industry and its reliability managers to human error.

Cooperative and complementary research and funding between nations and between government and industry efforts should be encouraged.

14. Establish a standing framework for the conduct of future blackout and disturbance investigations.¹⁷

The U.S., Canadian, and Mexican governments, in consultation with NERC, should establish a standing framework for the investigation of future blackouts, disturbances, or other significant grid-related incidents.

Fortunately, major blackouts are not frequent, which makes it important to study such events carefully to learn as much as possible from the experience. In the weeks immediately after August 14, important lessons were learned pertaining not only to preventing and minimizing future blackouts, but also to the efficient and fruitful investigation of future grid-related events.

Appropriate U.S., Canadian, and Mexican government agencies, in consultation with NERC and other organizations, should prepare an agreement that, among other considerations:

- ◆ Establishes criteria for determining when an investigation should be initiated.
- ◆ Establishes the composition of a task force to provide overall guidance for the inquiry. The task force should be international if the triggering event had international consequences.
- ◆ Provides for coordination with state and provincial governments, NERC and other appropriate entities.

- ◆ Designates agencies responsible for issuing directives concerning preservation of records, provision of data within specified periods to a data warehouse facility, conduct of onsite interviews with control room personnel, etc.
- ◆ Provides guidance on confidentiality of data.
- ◆ Identifies types of expertise likely to be needed on the investigation team.

Group II. Support and Strengthen NERC's Actions of February 10, 2004

On February 10, 2004, after taking the findings of the Task Force's investigation into the August 14, 2003, blackout into account, the NERC Board of Trustees approved a series of actions and strategic and technical initiatives intended to protect the reliability of the North American bulk electric system. (See Appendix D for the full text of the Board's statement of February 10.) Overall, the Task Force supports NERC's actions and initiatives strongly. On some subjects, the Task Force advocates additional measures, as shown in the next 17 recommendations.

15. Correct the direct causes of the August 14, 2003 blackout.¹⁸

NERC played an important role in the Task Force's blackout investigation, and as a result of the findings of the investigation, NERC issued directives on February 10, 2004 to FirstEnergy, MISO, and PJM to complete a series of remedial actions by June 30, 2004 to correct deficiencies identified as factors contributing to the blackout of August 14, 2003. (For specifics on the actions required by NERC, see Appendix D.)

The Task Force supports and endorses NERC's near-term requirements strongly. It recommends the addition of requirements pertaining to ECAR, and several other additional elements, as described below.

A. Corrective Actions to Be Completed by FirstEnergy by June 30, 2004

The full text of the remedial actions NERC has required that FirstEnergy (FE) complete by June 30 is provided in Appendix D. The Task Force recommends the addition of certain elements to these requirements, as described below.

1. Examination of Other FE Service Areas

The Task Force's investigation found severe reactive power and operations criteria deficiencies in the Cleveland-Akron area.

NERC:

Specified measures required in that area to help ensure the reliability of the FE system and avoid undue risks to neighboring systems. However, the blackout investigation did not examine conditions in FE service areas in other states.

Task Force:

Recommends that NERC require FE to review its entire service territory, in all states, to determine whether similar vulnerabilities exist and require prompt attention. This review should be completed by June 30, 2004, and the results reported to FERC, NERC, and utility regulatory authorities in the affected states.

2. Interim Voltage Criteria

NERC:

Required that FE, consistent with or as part of a study ordered by FERC on December 24, 2003,¹⁹ determine the minimum acceptable location-specific voltages at all 345 kV and 138 kV buses and all generating stations within the FE control area (including merchant plants). Further, FE is to determine the minimum dynamic reactive reserves that must be maintained in local areas to ensure that these minimum voltages are met following contingencies studied in accordance with ECAR Document 1.²⁰ Criteria and minimum voltage requirements must comply with NERC planning criteria, including Table 1A, Category C3, and Operating Policy 2.²¹

Task Force:

Recommends that NERC appoint a team, joined by representatives from FERC and the Ohio Public Utility Commission, to review and approve all such criteria.

3. FE Actions Based on FERC-Ordered Study

NERC:

Required that when the FERC-ordered study is completed, FE is to adopt the planning and operating criteria determined as a result of that study and update the operating criteria and procedures for its system operators. If the study indicates a need for system reinforcement, FE is to develop a plan for developing such resources as soon as practical and develop operational procedures or other mitigating programs to maintain safe operating conditions until such time that the necessary system reinforcements can be made.

Task Force:

Recommends that a team appointed by NERC and joined by representatives from FERC and the Ohio Public Utility Commission should review and approve this plan.

4. Reactive Resources

NERC:

Required that FE inspect all reactive resources, including generators, and ensure that all are fully operational. FE is also required to verify that all installed capacitors have no blown fuses and that at least 98% of installed capacitors (69 kV and higher) are available for service during the summer of 2004.

Task Force:

Recommends that NERC also require FE to confirm that all non-utility generators in its area have entered into contracts for the sale of generation committing them to producing increased or maximum reactive power when called upon by FE or MISO to do so. Such contracts should ensure that the generator would be compensated for revenue losses associated with a reduction in real power sales in order to increase production of reactive power.

5. Operational Preparedness and Action Plan

NERC:

Required that FE prepare and submit to ECAR an Operational Preparedness and Action Plan to ensure system security and full compliance with NERC and planning and operating criteria, including ECAR Document 1.

Task Force:

Recommends that NERC require copies of this plan to be provided to FERC, DOE, the Ohio Public Utility Commission, and the public utility commissions in other states in which FE operates. The Task Force also recommends that NERC require FE to invite its system operations partners—control areas adjacent to FE, plus MISO, ECAR, and PJM—to participate in the development of the plan and agree to its implementation in all aspects that could affect their respective systems and operations.

6. Emergency Response Resources

NERC:

Required that FE develop a capability to reduce load in the Cleveland-Akron area by 1500 MW within ten minutes of a directive to do so by MISO or the FE system operator. Such a

capability may be provided by automatic or manual load shedding, voltage reduction, direct-controlled commercial or residential load management, or any other method or combination of methods capable of achieving the 1500 MW of reduction in ten minutes without adversely affecting other interconnected systems. The amount of required load reduction capability may be modified to an amount shown by the FERC-ordered study to be sufficient for response to severe contingencies *and* if approved by ECAR and NERC.

Task Force:

Recommends that NERC require MISO's approval of any change in the amount of required load reduction capability. It also recommends that NERC require FE's load reduction plan to be shared with the Ohio Public Utilities Commission and that FE should communicate with all communities in the affected areas about the plan and its potential consequences.

7. Emergency Response Plan

NERC:

Required that FE develop an emergency response plan, including arrangements for deploying the load reduction capabilities noted above. The plan is to include criteria for determining the existence of an emergency and identify various possible states of emergency. The plan is to include detailed operating procedures and communication protocols with all the relevant entities including MISO, FE operators, and market participants within the FE area that have an ability to vary generation output or shed load upon orders from FE operators. The plan should include procedures for load restoration after the declaration that the FE system is no longer in an emergency operating state.

Task Force:

Recommends that NERC require FE to offer its system operations partners—i.e., control areas adjacent to FE, plus MISO, ECAR, and PJM—an opportunity to contribute to the development of the plan and agree to its key provisions.

8. Operator Communications

NERC:

Required that FE develop communications procedures for FE operating personnel to use within FE, with MISO and neighboring

systems, and others. The procedure and the operating environment within the FE system control center should allow control room staff to focus on reliable system operations and avoid distractions such as calls from customers and others who are not responsible for operation of a portion of the transmission system.

Task Force:

Recommends that NERC require these procedures to be shared with and agreed to by control areas adjacent to FE, plus MISO, ECAR, and PJM, and any other affected system operations partners, and that these procedures be tested in a joint drill.

9. Reliability Monitoring and System Management Tools

NERC:

Required that FE ensure that its state estimator and real-time contingency analysis functions are used to execute reliably full contingency analyses automatically every ten minutes or on demand, and used to notify operators of potential first contingency violations.

Task Force:

Recommends that NERC also require FE to ensure that its information technology support function does not change the effectiveness of reliability monitoring or management tools in any way without the awareness and consent of its system operations staff.

10. GE XA21 System Updates and Transition to New Energy Management System

NERC:

Required that until FE replaces its GE XA21 Energy Management System, FE should implement all current known fixes for the GE XA21 system necessary to ensure reliable and stable operation of critical reliability functions, and particularly to correct the alarm processor failure that occurred on August 14, 2003.

Task Force:

Recommends that NERC require FE to design and test the transition to its planned new energy management system to ensure that the system functions effectively, that the transition is made smoothly, that the system's operators are adequately trained, and that all operating partners are aware of the transition.

11. Emergency Preparedness Training for Operators

NERC:

Required that all reliability coordinators, control areas, and transmission operators provide at least five days of training and drills using realistic simulation of system emergencies for each staff person with responsibility for the real-time operation or reliability monitoring of the bulk electric system. This system emergency training is in addition to other training requirements. The term "realistic simulation" includes a variety of tools and methods that present operating personnel with situations to improve and test diagnostic and decision-making skills in an environment that resembles expected conditions during a particular type of system emergency.

Task Force:

Recommends that to provide effective training before June 30, 2004, NERC should require FE to consider seeking the assistance of another control area or reliability coordinator known to have a quality training program (such as IMO or ISO-New England) to provide the needed training with appropriate FE-specific modifications.

B. Corrective Actions to be Completed by MISO by June 30, 2004

1. Reliability Tools

NERC:

Required that MISO fully implement and test its topology processor to provide its operating personnel a real-time view of the system status for all transmission lines operating and all generating units within its system, and all critical transmission lines and generating units in neighboring systems. Alarms should be provided for operators for all critical transmission line outages and voltage violations. MISO is to establish a means of exchanging outage information with its members and adjacent systems such that the MISO state estimator has accurate and timely information to perform as designed. MISO is to fully implement and test its state estimation and real-time contingency analysis tools to ensure they can operate reliably no less than every ten minutes. MISO is to provide backup capability for all functions critical to reliability.

Task Force:

Recommends that NERC require MISO to ensure that its information technology support staff does not change the effectiveness of reliability monitoring or management tools in any way without the awareness and consent of its system operations staff.

2. Operating Agreements

NERC:

Required that MISO reevaluate its operating agreements with member entities to verify its authority to address operating issues, including voltage and reactive management, voltage scheduling, the deployment and redispatch of real and reactive reserves for emergency response, and the authority to direct actions during system emergencies, including shedding load.

Task Force:

Recommends that NERC require that any problems or concerns related to these operating issues be raised promptly with FERC and MISO's members for resolution.

C. Corrective Actions to be Completed by PJM by June 30, 2004

NERC:

Required that PJM reevaluate and improve its communications protocols and procedures between PJM and its neighboring control areas and reliability coordinators.

Task Force:

Recommends that NERC require definitions and usages of key terms be standardized, and non-essential communications be minimized during disturbances, alerts, or emergencies. NERC should also require PJM, MISO, and their member companies to conduct one or more joint drills using the new communications procedures.

D. Task Force Recommendations for Corrective Actions to be Completed by ECAR by August 14, 2004

1. Modeling and Assessments

Task Force:

Recommends that NERC require ECAR to reevaluate its modeling procedures, assumptions, scenarios and data for seasonal assessments and extreme conditions evaluations.

ECAR should consult with an expert team appointed by NERC—joined by representatives from FERC, DOE, interested state commissions, and MISO—to develop better modeling procedures and scenarios, and obtain review of future assessments by the expert team.

2. Verification of Data and Assumptions

Task Force:

Recommends that NERC require ECAR to reexamine and validate all data and model assumptions against current physical asset capabilities and match modeled assets (such as line characteristics and ratings, and generator reactive power output capabilities) to current operating study assessments.

3. Ensure Consistency of Members' Data

Task Force:

Recommends that NERC require ECAR to conduct a data validation and exchange exercise to be sure that its members are using accurate, consistent, and current physical asset characteristics and capabilities for both long-term and seasonal assessments and operating studies.

E. Task Force Recommendation for Corrective Actions to be Completed by Other Parties by June 30, 2004

Task Force:

Recommends that NERC require each North American reliability coordinator, reliability council, control area, and transmission company not directly addressed above to review the actions required above and determine whether it has adequate system facilities, operational procedures, tools, and training to ensure reliable operations for the summer of 2004. If any entity finds that improvements are needed, it should immediately undertake the needed improvements, and coordinate them with its neighbors and partners as necessary.

The Task Force also recommends that FERC and government agencies in Canada require all entities under their jurisdiction who are users of GE/Harris XA21 Energy Management Systems to consult the vendor and ensure that appropriate actions have been taken to avert any recurrence of the malfunction that occurred on FE's system on August 14.

16. Establish enforceable standards for maintenance of electrical clearances in right-of-way areas.²²

On February 10, the NERC Board directed the NERC Compliance Program and the regional councils to initiate a joint program for reporting all bulk electric system transmission line trips resulting from vegetation contact. Based on the results of these filings, NERC is to consider the development of minimum line clearance standards to ensure reliability.

The Task Force believes that more aggressive action is warranted. NERC should work with FERC, appropriate authorities in Canada, state regulatory agencies, the Institute of Electrical and Electronic Engineers (IEEE), utility arborists, and other experts from the US and Canada to develop clear, unambiguous standards pertaining to maintenance of safe clearances of transmission lines from obstructions in the lines' right-of-way areas, and to develop a mechanism to verify compliance with the standards and impose penalties for non-compliance.

Ineffective vegetation management was a major cause of the August 14, 2003, blackout and it was also a causal factor in other large-scale North American outages such as those that occurred in the summer of 1996 in the western United States. Maintaining transmission line rights-of-way, including maintaining safe clearances of energized lines from vegetation, man-made structures, bird nests, etc., requires substantial expenditures in many areas of North America. However, such maintenance is a critical investment for ensuring a reliable electric system. For a review of current issues pertaining to utility vegetation management programs, see *Utility Vegetation Management Final Report*, March 2004.²³

NERC does not presently have standards for right-of-way maintenance. However, it has standards requiring that line ratings be set to maintain safe clearances from all obstructions. Line rating standards should be reviewed to ensure that they are sufficiently clear and explicit. In the United States, National Electrical Safety Code (NESC) rules specify safety clearances required for overhead conductors from grounded objects and other types of obstructions, but those rules are subject to broad interpretation. Several states have adopted their own electrical safety codes and similar codes apply in Canada and its provinces. A mechanism is needed to verify compliance with these requirements and to penalize noncompliance.

A. Enforceable Standards

NERC should work with FERC, government agencies in Canada, state regulatory agencies, the Institute of Electrical and Electronic Engineers (IEEE), utility arborists, and other experts from the U.S. and Canada to develop clear, unambiguous standards pertaining to maintenance of safe clearances of transmission lines from obstructions in the lines' right-of-way areas, and procedures to verify compliance with the standards. States, provinces, and local governments should remain free to set more specific or higher standards as they deem necessary for their respective areas.

B. Right-of-Way Management Plan

NERC should require each bulk electric transmission operator to publish annually a proposed right-of-way management plan on its public website, and a report on its right-of-way management activities for the previous year. The management plan should include the planned frequency of actions such as right-of-way trimming, herbicide treatment, and inspections, and the report should give the dates when the rights-of-way in a given district were last inspected and corrective actions taken.

C. Requirement to Report Outages Due to Ground Faults in Right-of-Way Areas

Beginning with an effective date of March 31, 2004, NERC should require each transmission owner/operator to submit quarterly reports of all ground-fault line trips, including their causes, on lines of 115 kV and higher in its footprint to the regional councils. Failure to report such trips should lead to an appropriate penalty. Each regional council should assemble a detailed annual report on ground fault line trips and their causes in its area to FERC, NERC, DOE, appropriate authorities in Canada, and state regulators no later than March 31 for the preceding year, with the first annual report to be filed in March 2005 for calendar year 2004.

D. Transmission-Related Vegetation Management Expenses, if Prudently Incurred, Should be Recoverable through Electric Rates

The level of activity in vegetation management programs in many utilities and states has fluctuated widely from year to year, due in part to inconsistent funding and varying management support. Utility managers and regulators should recognize the importance of effective vegetation management to transmission system reliability, and that

changes in vegetation management may be needed in response to weather, insect infestations, and other factors. Transmission vegetation management programs should be consistently funded and proactively managed to maintain and improve system reliability.

17. Strengthen the NERC Compliance Enforcement Program.

On February 10, 2004, the NERC Board of Trustees approved directives to the regional reliability councils that will significantly strengthen NERC's existing Compliance Enforcement Program. The Task Force supports these directives strongly, and recommends certain additional actions, as described below.²⁴

A. Reporting of Violations

NERC:

Requires each regional council to report to the NERC Compliance Enforcement Program within one month of occurrence all "significant violations" of NERC operating policies and planning standards and regional standards, whether verified or still under investigation by the regional council. (A "significant violation" is one that could directly reduce the integrity of the interconnected power systems or otherwise cause unfavorable risk to the interconnected power systems.) In addition, each regional council is to report quarterly to NERC, in a format prescribed by NERC, all violations of NERC and regional reliability standards.

Task Force:

Recommends that NERC require the regional councils' quarterly reports and reports on significant violations be filed as public documents with FERC and appropriate authorities in Canada, at the same time that they are sent to NERC.

B. Enforcement Action by NERC Board

NERC:

After being presented with the results of the investigation of a significant violation, the Board is to require an offending organization to correct the violation within a specified time. If the Board determines that the organization is non-responsive and continues to cause a risk to the reliability of the interconnected power systems, the Board will seek to remedy the violation by requesting assistance from appropriate

regulatory authorities in the United States and Canada.

Task Force:

Recommends that NERC inform the federal and state or provincial authorities of both countries of the final results of all enforcement proceedings, and make the results of such proceedings public.

C. Violations in August 14, 2003 Blackout

NERC:

The Compliance and Standards investigation team will issue a final report in March or April of 2004 of violations of NERC and regional standards that occurred on August 14. (Seven violations are noted in this report (pages 19-20), but additional violations may be identified by NERC.) Within three months of the issuance of the report, NERC is to develop recommendations to improve the compliance process.

Task Force:

Recommends that NERC make its recommendations available to appropriate U.S. federal and state authorities, to appropriate authorities in Canada, and to the public.

D. Compliance Audits

NERC:

Established plans for two types of audits, compliance audits and readiness audits. Compliance audits would determine whether the subject entity is in documented compliance with NERC standards, policies, etc. Readiness audits focus on whether the entity is functionally capable of meeting the terms of its reliability responsibilities. Under the terms approved by NERC's Board, the readiness audits to be completed by June 30, 2004, will be conducted using existing NERC rules, policies, standards, and NERC compliance templates. Requirements for control areas will be based on the existing NERC Control Area Certification Procedure, and updated as new criteria are approved.

Task Force:

Supports the NERC effort to verify that all entities are compliant with reliability standards. Effective compliance and auditing will require that the NERC standards be improved rapidly to make them clear, unambiguous, measurable, and consistent with the Functional Model.

E. Audit Standards and Composition of Audit Teams

NERC:

Under the terms approved by the Board, the regional councils are to have primary responsibility for conducting the compliance audits, under the oversight and direct participation of staff from the NERC Compliance Enforcement Program. FERC and other relevant regulatory agencies will be invited to participate in the audits, subject to the same confidentiality conditions as the other team members.

Task Force:

Recommends that each team should have some members who are electric reliability experts from outside the region in which the audit is occurring. Also, some team members should be from outside the electricity industry, i.e., individuals with experience in systems engineering and management, such as persons from the nuclear power industry, the U.S. Navy, the aerospace industry, air traffic control, or other relevant industries or government agencies. To improve the objectivity and consistency of investigation and performance, NERC-organized teams should conduct these compliance audits, using NERC criteria (with regional variations if more stringent), as opposed to the regional councils using regionally developed criteria.

F. Public Release of Compliance Audit Reports

Task Force:

Recommends that NERC require all compliance audit reports to be publicly posted, excluding portions pertaining to physical and cyber security according to predetermined criteria. Such reports should draw clear distinctions between serious and minor violations of reliability standards or related requirements.

18. Support and strengthen NERC's Reliability Readiness Audit Program.²⁵

On February 10, 2004, the NERC Board of Trustees approved the establishment of a NERC program for periodic reviews of the reliability readiness of all reliability coordinators and control areas. The Task Force strongly supports this action, and recommends certain additional measures, as described below.

A. Readiness Audits

NERC:

In its directives of February 10, 2004, NERC indicated that it and the regional councils would jointly establish a program to audit the reliability readiness of all reliability coordinators and control areas within three years and continuing thereafter on a three-year cycle. Twenty audits of high-priority areas will be completed by June 30, 2004, with particular attention to deficiencies identified in the investigation of the August 14 blackout.

Task Force:

Recommends that the remainder of the first round of audits be completed within two years, as compared to NERC's plan for three years.

B. Public Release of Readiness Audit Reports

Task Force:

Recommends that NERC require all readiness audit reports to be publicly posted, excluding portions pertaining to physical and cyber security. Reports should also be sent directly to DOE, FERC, and relevant authorities in Canada and state commissions. Such reports should draw clear distinctions between serious and minor violations of reliability standards or related requirements.

19. Improve near-term and long-term training and certification requirements for operators, reliability coordinators, and operator support staff.²⁶

In its requirements of February 10, 2004, NERC directed that all reliability coordinators, control areas, and transmission operators are to provide at least five days per year of training and drills in system emergencies, using realistic simulations, for each staff person with responsibility for the real-time operation or reliability monitoring of the bulk electric system. This system emergency training is in addition to other training requirements. Five days of system emergency training and drills are to be completed by June 30, 2004.

The Task Force supports these near-term requirements strongly. For the long term, the Task Force recommends that:

A. NERC should require training for the planning staff at control areas and reliability coordinators concerning power system characteristics

and load, VAR, and voltage limits, to enable them to develop rules for operating staff to follow.

B. NERC should require control areas and reliability coordinators to train grid operators, IT support personnel, and their supervisors to recognize and respond to abnormal automation system activity.

C. NERC should commission an advisory report by an independent panel to address a wide range of issues concerning reliability training programs and certification requirements.

The Task Force investigation team found that some reliability coordinators and control area operators had not received adequate training in recognizing and responding to system emergencies. Most notable was the lack of realistic simulations and drills to train and verify the capabilities of operating personnel. Such simulations are essential if operators and other staff are to be able to respond adequately to emergencies. This training deficiency contributed to the lack of situational awareness and failure to declare an emergency on August 14 while operator intervention was still possible (before events began to occur at a speed beyond human control).

Control rooms must remain functional under a wide range of possible conditions. Any person with access to a control room should be trained so that he or she understands the basic functions of the control room, and his or her role in relation to those of others in the room under any conditions. Information technology (IT) staff, in particular, should have a detailed understanding of the information needs of the system operators under alternative conditions.

The Task Force's cyber investigation team noted in its site visits an increasing reliance by control areas and utilities on automated systems to measure, report on, and change a wide variety of physical processes associated with utility operations.²⁷ If anything, this trend is likely to intensify in the future. These systems enable the achievement of major operational efficiencies, but their failure could cause or contribute to blackouts, as evidenced by the alarm failures at FirstEnergy and the state estimator deactivation at MISO.

Grid operators should be trained to recognize and respond more efficiently to security and automation problems, reinforced through the use of periodic exercises. Likewise, IT support personnel should be better trained to understand and respond to the requirements of grid operators during security and IT incidents.

NERC's near-term requirements for emergency preparedness training are described above. For the long term, training for system emergencies should be fully integrated into the broader training programs required for all system planners, system operators, their supervisors, and other control room support staff.

Advisory Report by Independent Panel on Industry Training Programs and Certification Requirements

Under the oversight of FERC and appropriate Canadian authorities, the Task Force recommends that NERC commission an independent advisory panel of experts to design and propose minimum training programs and certification procedures for the industry's control room managers and staff. This panel should be comprised of experts from electric industry organizations with outstanding training programs, universities, and other industries that operate large safety or reliability-oriented systems and training programs. (The Institute of Nuclear Power Operations (INPO), for example, provides training and other safety-related services to operators of U.S. nuclear power plants and plants in other countries.) The panel's report should provide guidance on issues such as:

1. Content of programs for new trainees
2. Content of programs for existing operators and other categories of employees
3. Content of continuing education programs and fraction of employee time to be committed to ongoing training
4. Going beyond paper-based, fact-oriented "knowledge" requirements for operators—i.e., confirming that an individual has the ability to cope with unforeseen situations and emergencies
5. In-house training vs. training by independent parties
6. Periodic accreditation of training programs
7. Who should certify trained staff?
8. Criteria to establish grades or levels of operator qualifications from entry level to supervisor or manager, based on education, training, and experience.

The panel's report should be delivered by March 31, 2005. FERC and Canadian authorities, in consultation with NERC and others, should evaluate the report and consider its findings in setting

minimum training and certification requirements for control areas and reliability coordinators.

20. Establish clear definitions for *normal*, *alert* and *emergency* operational system conditions. Clarify roles, responsibilities, and authorities of reliability coordinators and control areas under each condition.²⁸

NERC should develop by June 30, 2004 definitions for normal, alert, and emergency system conditions, and clarify reliability coordinator and control area functions, responsibilities, required capabilities, and required authorities under each operational system condition.

System operators need common definitions for normal, alert, and emergency conditions to enable them to act appropriately and predictably as system conditions change. On August 14, the principal entities involved in the blackout did not have a shared understanding of whether the grid was in an emergency condition, nor did they have a common understanding of the functions, responsibilities, capabilities, and authorities of reliability coordinators and control areas under emergency or near-emergency conditions.

NERC:

On February 10, 2004, NERC's Board of Trustees directed NERC's Operating Committee to "clarify reliability coordinator and control area functions, responsibilities, capabilities, and authorities" by June 30, 2004.

Task Force:

Recommends that NERC go further and develop clear definitions of three operating system conditions, along with clear statements of the roles and responsibilities of all participants, to ensure effective and timely actions in critical situations.

Designating three alternative system conditions (normal, alert, and emergency) would help grid managers to avert and deal with emergencies through preventive action. Many difficult situations are avoidable through strict adherence to sound procedures during normal operations. However, unanticipated difficulties short of an emergency still arise, and they must be addressed swiftly and skillfully to prevent them from becoming emergencies. Doing so requires a high level of situational awareness that is difficult to sustain indefinitely, so an intermediate "alert" state is

needed, between "normal" and "emergency." In some areas (e.g., NPCC) an "alert" state has already been established.

21. Make more effective and wider use of system protection measures.²⁹

In its requirements of February 10, 2004, NERC:

- A. Directed all transmission owners to evaluate the settings of zone 3 relays on all transmission lines of 230 kV and higher.**
- B. Directed all regional councils to evaluate the feasibility and benefits of installing under-voltage load shedding capability in load centers.**
- C. Called for an evaluation within one year of its planning standard on system protection and control to take into account the lessons from the August 14 blackout.**

The Task Force supports these actions strongly, and recommends certain additional measures, as described below.

A. Evaluation of Zone 3 Relays

NERC:

Industry is to review zone 3 relays on lines of 230 kV and higher.

Task Force:

Recommends that NERC broaden the review to include operationally significant 115 kV and 138 kV lines, e.g., lines that are part of monitored flowgates or interfaces. Transmission owners should also look for zone 2 relays set to operate like zone 3s.

B. Evaluation of Applicability of Under-Voltage Load Shedding

NERC:

Required each regional reliability council to evaluate the feasibility and benefits of under-voltage load shedding (UVLS) capability in load centers that could become unstable as a result of insufficient reactive power following credible multiple-contingency events. The regions should complete the initial studies and report the results to NERC within one year. The regions should promote the installation of under-voltage load shedding capabilities within critical areas where beneficial, as determined by the studies to be effective in preventing or containing an uncontrolled cascade of the power system.

Task Force:

Recommends that NERC require the results of the regional studies to be provided to federal and state or provincial regulators at the same time that they are reported to NERC. In addition, NERC should require every entity with a new or existing UVLS program to have a well-documented set of guidelines for operators that specify the conditions and triggers for UVLS use.

**C. Evaluation of NERC's Planning Standard III
NERC:**

Plans to evaluate Planning Standard III, System Protection and Control, and propose, by March 1, 2005, specific revisions to the criteria to address adequately the issue of slowing or limiting the propagation of a cascading failure, in light of the experience gained on August 14.

Task Force:

Recommends that NERC, as part of the review of Planning Standard III, determine the goals and principles needed to establish an integrated approach to relay protection for generators and transmission lines and the use of under-frequency and under-voltage load shedding (UFLS and UVLS) programs. An integrated approach is needed to ensure that at the local and regional level these interactive components provide an appropriate balance of risks and benefits in terms of protecting specific assets and facilitating overall grid survival. This review should take into account the evidence from August 14 of some unintended consequences of installing Zone 3 relays and using manufacturer-recommended settings for relays protecting generators. It should also include an assessment of the appropriate role and scope of UFLS and UVLS, and the appropriate use of time delays in relays.

Recommends that in this effort NERC should work with industry and government research organizations to assess the applicability of existing and new technology to make the interconnections less susceptible to cascading outages.

22. Evaluate and adopt better real-time tools for operators and reliability coordinators.³⁰

NERC's requirements of February 10, 2004, direct its Operating Committee to evaluate within one

year the real-time operating tools necessary for reliability operation and reliability coordination, including backup capabilities. The committee's report is to address both minimum acceptable capabilities for critical reliability functions and a guide to best practices.

The Task Force supports these requirements strongly. It recommends that NERC require the committee to:

- A. Give particular attention in its report to the development of guidance to control areas and reliability coordinators on the use of automated wide-area situation visualization display systems and the integrity of data used in those systems.**
- B. Prepare its report in consultation with FERC, appropriate authorities in Canada, DOE, and the regional councils. The report should also inform actions by FERC and Canadian government agencies to establish minimum functional requirements for control area operators and reliability coordinators.**

The Task Force also recommends that FERC, DHS, and appropriate authorities in Canada should require annual independent testing and certification of industry EMS and SCADA systems to ensure that they meet the minimum requirements envisioned in Recommendation 3.

A principal cause of the August 14 blackout was a lack of situational awareness, which was in turn the result of inadequate reliability tools and backup capabilities. In addition, the failure of FE's control computers and alarm system contributed directly to the lack of situational awareness. Likewise, MISO's incomplete tool set and the failure to supply its state estimator with correct system data on August 14 contributed to the lack of situational awareness. The need for improved visualization capabilities over a wide geographic area has been a recurrent theme in blackout investigations. Some wide-area tools to aid situational awareness (e.g., real-time phasor measurement systems) have been tested in some regions but are not yet in general use. Improvements in this area will require significant new investments involving existing or emerging technologies.

The investigation of the August 14 blackout revealed that there has been no consistent means across the Eastern Interconnection to provide an understanding of the status of the power grid outside of a control area. Improved visibility of the status of the grid beyond an operator's own area of control would aid the operator in making adjustments in its operations to mitigate potential

problems. The expanded view advocated above would also enable facilities to be more proactive in operations and contingency planning.

Annual testing and certification by independent, qualified parties is needed because EMS and SCADA systems are the nerve centers of bulk electric networks. Ensuring that these systems are functioning properly is critical to sound and reliable operation of the networks.

23. Strengthen reactive power and voltage control practices in all NERC regions.³¹

NERC's requirements of February 10, 2004 call for a reevaluation within one year of existing reactive power and voltage control standards and how they are being implemented in the ten NERC regions. However, by June 30, 2004, ECAR is required to review its reactive power and voltage criteria and procedures, verify that its criteria and procedures are being fully implemented in regional and member studies and operations, and report the results to the NERC Board.

The Task Force supports these requirements strongly. It recommends that NERC require the regional analyses to include recommendations for appropriate improvements in operations or facilities, and to be subject to rigorous peer review by experts from within and outside the affected areas.

The Task Force also recommends that FERC and appropriate authorities in Canada require all tariffs or contracts for the sale of generation to include provisions specifying that the generators can be called upon to provide or increase reactive power output if needed for reliability purposes, and that the generators will be paid for any lost revenues associated with a reduction of real power sales attributable to a required increase in the production of reactive power.

Reactive power problems were a significant factor in the August 14 outage, and they were also important elements in several of the earlier outages detailed in Chapter 7.³² Accordingly, the Task Force agrees that a comprehensive review is needed of North American practices with respect to managing reactive power requirements and maintaining an appropriate balance among alternative types of reactive resources.

Regional Analyses, Peer Reviews, and Follow-Up Actions

The Task Force recommends that each regional reliability council, working with reliability coordinators and the control areas serving major load centers, should conduct a rigorous reliability and

adequacy analysis comparable to that outlined in FERC's December 24, 2003, Order³³ to FirstEnergy concerning the Cleveland-Akron area. The Task Force recommends that NERC develop a prioritized list for which areas and loads need this type of analysis and a schedule that ensures that the analysis will be completed for all such load centers by December 31, 2005.

24. Improve quality of system modeling data and data exchange practices.³⁴

NERC's requirements of February 10, 2004 direct that within one year the regional councils are to establish and begin implementing criteria and procedures for validating data used in power flow

models and dynamic simulations by benchmarking model data with actual system performance. Validated modeling data shall be exchanged on an inter-regional basis as needed for reliable system planning and operation.

The Task Force supports these requirements strongly. The Task Force also recommends that FERC and appropriate authorities in Canada require all generators, regardless of ownership, to collect and submit generator data to NERC, using a regulator-approved template.

The after-the-fact models developed to simulate August 14 conditions and events found that the dynamic modeling assumptions for generator and load power factors in regional planning and operating models were frequently inaccurate. In particular, the assumptions of load power factor were overly optimistic—loads were absorbing much more reactive power than the pre-August 14 models indicated. Another suspected problem concerns modeling of shunt capacitors under depressed voltage conditions.

NERC should work with the regional reliability councils to establish regional power system models that enable the sharing of consistent and validated data among entities in the region. Power flow and transient stability simulations should be periodically benchmarked with actual system events to validate model data. Viable load (including load power factor) and generator testing programs are necessary to improve agreement between power flows and dynamic simulations and the actual system performance.

During the data collection phase of the blackout investigation, when control areas were asked for information pertaining to merchant generation within their area, the requested data was

frequently not available because the control area had not recorded the status or output of the generator at a given point in time. Some control area operators also asserted that some of the data that did exist was commercially sensitive or confidential. To correct such problems, the Task Force recommends that FERC and authorities in Canada require all generators, regardless of ownership, to collect and submit generator data, according to a regulator-approved template.

25. NERC should reevaluate its existing reliability standards development process and accelerate the adoption of enforceable standards.³⁵

The Task Force recommends that, with support from FERC and appropriate authorities in Canada, NERC should:

- A. Re-examine its existing body of standards, guidelines, etc., to identify those that are most important and ensure that all concerns that merit standards are addressed in the plan for standards development.**
- B. Re-examine the plan to ensure that those that are the most important or the most out-of-date are addressed early in the process.**
- C. Build on existing provisions and focus on what needs improvement, and incorporate compliance and readiness considerations into the drafting process.**
- D. Re-examine the Standards Authorization Request process to determine whether, for each standard, a review and modification of an existing standard would be more efficient than development of wholly new text for the standard.**

NERC has already begun a long-term, systematic process to reevaluate its standards. It is of the greatest importance, however, that this process not dilute the content of the existing standards, nor conflict with the right of regions or other areas to impose more stringent standards. The state of New York, for example, operates under mandatory and more stringent reliability rules and standards than those required by NERC and NPCC.³⁶

Similarly, several commenters on the Interim Report wrote jointly that:

NERC standards are the minimum—national standards should always be minimum rather than absolute or “one size fits all” criteria. [Systems for] densely populated areas, like the metropolitan areas of New York, Chicago, or

Washington, must be designed and operated in accordance with a higher level of reliability than would be appropriate for sparsely populated parts of the country. It is essential that regional differences in terms of load and population density be recognized in the application of planning and operating criteria. Any move to adopt a national, “one size fits all” formula for all parts of the United States would be disastrous to reliability

A strong transmission system designed and operated in accordance with weakened criteria would be disastrous. Instead, a concerted effort should be undertaken to determine if existing reliability criteria should be strengthened. Such an effort would recognize the geo-electrical magnitude of today’s interconnected networks, and the increased complexities deregulation and restructuring have introduced in planning and operating North American power systems. Most important, reliability should be considered a higher priority than commercial use. Only through strong standards and careful engineering can unacceptable power failures like the August 14 blackout be avoided in the future.³⁷

26. Tighten communications protocols, especially for communications during alerts and emergencies. Upgrade communication system hardware where appropriate.³⁸

NERC should work with reliability coordinators and control area operators to improve the effectiveness of internal and external communications during alerts, emergencies, or other critical situations, and ensure that all key parties, including state and local officials, receive timely and accurate information. NERC should task the regional councils to work together to develop communications protocols by December 31, 2004, and to assess and report on the adequacy of emergency communications systems within their regions against the protocols by that date.

On August 14, 2003, reliability coordinator and control area communications regarding conditions in northeastern Ohio were in some cases ineffective, unprofessional, and confusing. Ineffective communications contributed to a lack of situational awareness and precluded effective actions to prevent the cascade. Consistent application of effective communications protocols, particularly during alerts and emergencies, is essential to reliability. Standing hotline networks,

or a functional equivalent, should be established for use in alerts and emergencies (as opposed to one-on-one phone calls) to ensure that all key parties are able to give and receive timely and accurate information.

27. Develop enforceable standards for transmission line ratings.³⁹

NERC should develop clear, unambiguous requirements for the calculation of transmission line ratings (including dynamic ratings), and require that all lines of 115 kV or higher be rerated according to these requirements by June 30, 2005.

As seen on August 14, inadequate vegetation management can lead to the loss of transmission lines that are not overloaded, at least not according to their rated limits. The investigation of the blackout, however, also found that even after allowing for regional or geographic differences, there is still significant variation in how the ratings of existing lines have been calculated. This variation—in terms of assumed ambient temperatures, wind speeds, conductor strength, and the purposes and duration of normal, seasonal, and emergency ratings—makes the ratings themselves unclear, inconsistent, and unreliable across a region or between regions. This situation creates unnecessary and unacceptable uncertainties about the safe carrying capacity of individual lines on the transmission networks. Further, the appropriate use of dynamic line ratings needs to be included in this review because adjusting a line's rating according to changes in ambient conditions may enable the line to carry a larger load while still meeting safety requirements.

28. Require use of time-synchronized data recorders.⁴⁰

In its requirements of February 10, 2004, NERC directed the regional councils to define within one year regional criteria for the application of synchronized recording devices in key power plants and substations.

The Task Force supports the intent of this requirement strongly, but it recommends a broader approach:

A. FERC and appropriate authorities in Canada should require the use of data recorders synchronized by signals from the Global Positioning System (GPS) on all categories of facilities whose data may be needed to

investigate future system disturbances, outages, or blackouts.

B. NERC, reliability coordinators, control areas, and transmission owners should determine where high speed power system disturbance recorders are needed on the system, and ensure that they are installed by December 31, 2004.

C. NERC should establish data recording protocols.

D. FERC and appropriate authorities in Canada should ensure that the investments called for in this recommendation will be recoverable through transmission rates.

A valuable lesson from the August 14 blackout is the importance of having time-synchronized system data recorders. The Task Force's investigators labored over thousands of data items to determine the sequence of events, much like putting together small pieces of a very large puzzle. That process would have been significantly faster and easier if there had been wider use of synchronized data recording devices.

NERC Planning Standard I.F, Disturbance Monitoring, requires the use of recording devices for disturbance analysis. On August 14, time recorders were frequently used but not synchronized to a time standard. Today, at a relatively modest cost, all digital fault recorders, digital event recorders, and power system disturbance recorders can and should be time-stamped at the point of observation using a Global Positioning System (GPS) synchronizing signal. (The GPS signals are synchronized with the atomic clock maintained in Boulder, Colorado by the U.S. National Institute of Standards and Technology.) Recording and time-synchronization equipment should be monitored and calibrated to assure accuracy and reliability.

It is also important that data from automation systems be retained at least for some minimum period, so that if necessary it can be archived to enable adequate analysis of events of particular interest.

29. Evaluate and disseminate lessons learned during system restoration.⁴¹

In the requirements it issued on February 10, 2004, NERC directed its Planning Committee to work with the Operating Committee, NPCC, ECAR, and PJM to evaluate the black start and system restoration performance following the outage of August 14, and to report within one year the results of that evaluation, with recommendations for

improvement. Within six months of the Planning Committee's report, all regional councils are to have reevaluated their plans and procedures to ensure an effective black start and restoration capability within their region.

The Task Force supports these requirements strongly. In addition, the Task Force recommends that NERC should require the Planning Committee's review to include consultation with appropriate stakeholder organizations in all areas that were blacked out on August 14.

The efforts to restore the power system and customer service following the outage were generally effective, considering the massive amount of load lost and the large number of generators and transmission lines that tripped. Fortunately, the restoration was aided by the ability to energize transmission from neighboring systems, thereby speeding the recovery.

Despite the apparent success of the restoration effort, it is important to evaluate the results in more detail to compare them with previous black-out/restoration studies and determine opportunities for improvement. Black start and restoration plans are often developed through study of simulated conditions. Robust testing of live systems is difficult because of the risk of disturbing the system or interrupting customers. The August 14 blackout provides a valuable opportunity to review actual events and experiences to learn how to better prepare for system black start and restoration in the future. That opportunity should not be lost.

30. Clarify criteria for identification of operationally critical facilities, and improve dissemination of updated information on unplanned outages.⁴²

NERC should work with the control areas and reliability coordinators to clarify the criteria for identifying critical facilities whose operational status can affect the reliability of neighboring areas, and to improve mechanisms for sharing information about unplanned outages of such facilities in near real-time.

The lack of accurate, near real-time information about unplanned outages degraded the performance of state estimator and reliability assessment functions on August 14. NERC and the industry must improve the mechanisms for sharing outage information in the operating time horizon (e.g., 15 minutes or less), to ensure the accurate and timely sharing of outage data needed by real-time operating tools such as state

estimators, real-time contingency analyzers, and other system monitoring tools.

Further, NERC's present operating policies do not specify adequately criteria for identifying those critical facilities within reliability coordinator and control area footprints whose operating status could affect the reliability of neighboring systems. This leads to uncertainty about which facilities should be monitored by both the reliability coordinator for the region in which the facility is located and by one or more neighboring reliability coordinators.

31. Clarify that the transmission loading relief (TLR) process should not be used in situations involving an actual violation of an Operating Security Limit. Streamline the TLR process.⁴³

NERC should clarify that the TLR procedure is often too slow for use in situations in which an affected system is already in violation of an Operating Security Limit. NERC should also evaluate experience to date with the TLR procedure and propose by September 1, 2004, ways to make it less cumbersome.

The reviews of control area and reliability coordinator transcripts from August 14 confirm that the TLR process is cumbersome, perhaps unnecessarily so, and not fast and predictable enough for use situations in which an Operating Security Limit is close to or actually being violated. NERC should develop an alternative to TLRs that can be used quickly to address alert and emergency conditions.

Group III. Physical and Cyber Security of North American Bulk Power Systems

32. Implement NERC IT standards.

The Task Force recommends that NERC standards related to physical and cyber security should be understood as being included within the body of standards to be made mandatory and enforceable in Recommendation No. 1. Further:

- A. NERC should ensure that the industry has implemented its Urgent Action Standard 1200; finalize, implement, and ensure membership compliance with its Reliability Standard 1300 for Cyber Security and take actions to better communicate and enforce these standards.**
- B. CAs and RCs should implement existing and emerging NERC standards, develop and implement best practices and policies for IT and**

security management, and authenticate and authorize controls that address EMS automation system ownership and boundaries.

Interviews and analyses conducted by the SWG indicate that within some of the companies interviewed there are potential opportunities for cyber system compromise of EMS and their supporting IT infrastructure. Indications of procedural and technical IT management vulnerabilities were observed in some facilities, such as unnecessary software services not denied by default, loosely controlled system access and perimeter control, poor patch and configuration management, and poor system security documentation.

An analysis of the more prevalent policies and standards within the electricity sector revealed that there is existing and expanding guidance on standards within the sector to perform IT and information security management.⁴⁴ NERC issued a temporary standard (Urgent Action Standard 1200, Cyber Security) on August 13, 2003, and is developing the formal Reliability Standard 1300 for Cyber Security. Both start the industry down the correct path, but there is a need to communicate and enforce these standards by providing the industry with recommended implementation guidance. Implementation guidance regarding these sector-wide standards is especially important given that implementation procedures may differ among CAs and RCs.

In order to address the finding described above, the Task Force recommends:

◆ NERC:

- Ensure that the industry has implemented its Urgent Action Standard 1200 and determine if the guidance contained therein needs to be strengthened or amended in the ongoing development of its Reliability Standard 1300 for Cyber Security.
- Finalize, implement, and ensure membership compliance of its Reliability Standard 1300 for Cyber Security and take actions to better communicate and enforce these standards. These actions should include, but not necessarily be limited to:
 1. The provision of policy, process, and implementation guidance to CAs and RCs; and
 2. The establishment of mechanisms for compliance, audit, and enforcement. This may include recommendations, guidance, or agreements between NERC, CAs and RCs

that cover self-certification, self-assessment, and/or third-party audit.

- Work with federal, state, and provincial/territorial jurisdictional departments and agencies to regularly update private and public sector standards, policies, and other guidance.

◆ CAs and RCs:

- Implement existing and emerging NERC standards.
- Develop and implement best practices and policies for IT and security management drawing from existing NERC and government authorities' best practices.⁴⁵ These should include, but not necessarily be limited to:
 1. Policies requiring that automation system products be delivered and installed with unnecessary services deactivated in order to improve "out-of-the-box security."
 2. The creation of centralized system administration authority within each CA and RC to manage access and permissions for automation access (including vendor management backdoors, links to other automation systems, and administrative connections).
- Authenticate and authorize controls that address EMS automation system ownership and boundaries, and ensure access is granted only to users who have corresponding job responsibilities.

33. Develop and deploy IT management procedures.

CAs' and RCs' IT and EMS support personnel should develop procedures for the development, testing, configuration, and implementation of technology related to EMS automation systems and also define and communicate information security and performance requirements to vendors on a continuing basis. Vendors should ensure that system upgrades, service packs, and bug fixes are made available to grid operators in a timely manner.

Interviews and analyses conducted by the SWG indicate that, in some instances, there were ill-defined and/or undefined procedures for EMS automation systems software and hardware development, testing, deployment, and backup. In addition, there were specific instances of failures to perform system upgrade, version control, maintenance, rollback, and patch management tasks.

At one CA, these procedural vulnerabilities were compounded by inadequate, out-of-date, or non-

existing maintenance contracts with EMS vendors and contractors. This could lead to situations where grid operators could alter EMS components without vendor notification or authorization as well as scenarios in which grid operators are not aware of or choose not to implement vendor-recommended patches and upgrades.

34. Develop corporate-level IT security governance and strategies.

CAs and RCs and other grid-related organizations should have a planned and documented security strategy, governance model, and architecture for EMS automation systems.

Interviews and analysis conducted by the SWG indicate that in some organizations there is evidence of an inadequate security policy, governance model, strategy, or architecture for EMS automation systems. This is especially apparent with legacy EMS automation systems that were originally designed to be stand-alone systems but that are now interconnected with internal (corporate) and external (vendors, Open Access Same Time Information Systems (OASIS), RCs, Internet, etc.) networks. It should be noted that in some of the organizations interviewed this was not the case and in fact they appeared to excel in the areas of security policy, governance, strategy, and architecture.

In order to address the finding described above, the Task Force recommends that CAs, RCs, and other grid-related organizations have a planned and documented security strategy, governance model, and architecture for EMS automation systems covering items such as network design, system design, security devices, access and authentication controls, and integrity management as well as backup, recovery, and contingency mechanisms.

35. Implement controls to manage system health, network monitoring, and incident management.

IT and EMS support personnel should implement technical controls to detect, respond to, and recover from system and network problems. Grid operators, dispatchers, and IT and EMS support personnel should be provided the tools and training to ensure that the health of IT systems is monitored and maintained.

Interviews and analysis conducted by the SWG indicate that in some organizations there was

ineffective monitoring and control over EMS-supporting IT infrastructure and overall IT network health. In these cases, both grid operators and IT support personnel did not have situational awareness of the health of the IT systems that provide grid information both globally and locally. This resulted in an inability to detect, assess, respond to, and recover from IT system-related cyber failures (failed hardware/software, malicious code, faulty configurations, etc.).

In order to address the finding described above, the Task Force recommends:

- ◆ IT and EMS support personnel implement technical controls to detect, respond to, and recover from system and network problems.
- ◆ Grid operators, dispatchers, and IT and EMS support personnel be provided with the tools and training to ensure that:
 - The health of IT systems is monitored and maintained.
 - These systems have the capability to be repaired and restored quickly, with a minimum loss of time and access to global and internal grid information.
 - Contingency and disaster recovery procedures exist and can serve to temporarily substitute for systems and communications failures during times when EMS automation system health is unknown or unreliable.
 - Adequate verbal communication protocols and procedures exist between operators and IT and EMS support personnel so that operators are aware of any IT-related problems that may be affecting their situational awareness of the power grid.

36. Initiate a U.S.-Canada risk management study.

In cooperation with the electricity sector, federal governments should strengthen and expand the scope of the existing risk management initiatives by undertaking a bilateral (Canada-U.S.) study of the vulnerabilities of shared electricity infrastructure and cross border interdependencies. Common threat and vulnerability assessment methodologies should be also developed, based on the work undertaken in the pilot phase of the current joint Canada-U.S. vulnerability assessment initiative, and their use promoted by CAs and RCs. To coincide with these initiatives, the electricity sector, in association with federal governments, should

develop policies and best practices for effective risk management and risk mitigation.

Effective risk management is a key element in assuring the reliability of our critical infrastructures. It is widely recognized that the increased reliance on IT by critical infrastructure sectors, including the energy sector, has increased the vulnerability of these systems to disruption via cyber means. The breadth of the August 14, 2003, power outage illustrates the vulnerabilities and interdependencies inherent in our electricity infrastructure.

Canada and the United States, recognizing the importance of assessing the vulnerabilities of shared energy systems, included a provision to address this issue in the Smart Border Declaration,⁴⁶ signed on December 12, 2001. Both countries committed, pursuant to Action Item 21 of the Declaration, to “conduct bi-national threat assessments on trans-border infrastructure and identify necessary protection measures, and initiate assessments for transportation networks and other critical infrastructure.” These joint assessments will serve to identify critical vulnerabilities, strengths and weaknesses while promoting the sharing and transfer of knowledge and technology to the energy sector for self-assessment purposes.

A team of Canadian and American technical experts, using methodology developed by the Argonne National Laboratory in Chicago, Illinois, began conducting the pilot phase of this work in January 2004. The work involves a series of joint Canada-U.S. assessments of selected shared critical energy infrastructure along the Canada-U.S. border, including the electrical transmission lines and dams at Niagara Falls - Ontario and New York. The pilot phase will be completed by March 31, 2004.

The findings of the ESWG and SWG suggest that among the companies directly involved in the power outage, vulnerabilities and interdependencies of the electric system were not well understood and thus effective risk management was inadequate. In some cases, risk assessments did not exist or were inadequate to support risk management and risk mitigation plans.

In order to address these findings, the Task Force recommends:

- ◆ In cooperation with the electricity sector, federal governments should strengthen and expand the scope of the existing initiatives described above by undertaking a bilateral

(Canada-U.S.) study of the vulnerabilities of shared electricity infrastructure and cross border interdependencies. The study should encompass cyber, physical, and personnel security processes and include mitigation and best practices, identifying areas that would benefit from further standardization.

- ◆ Common threat and vulnerability assessment methodologies should be developed, based on the work undertaken in the pilot phase of the current joint Canada-U.S. vulnerability assessment initiative, and their use promoted by CAs and RCs.
- ◆ The electricity sector, in association with federal governments, should develop policies and best practices for effective risk management and risk mitigation.

37. Improve IT forensic and diagnostic capabilities.

CAs and RCs should seek to improve internal forensic and diagnostic capabilities, ensure that IT support personnel who support EMS automation systems are familiar with the systems’ design and implementation, and make certain that IT support personnel who support EMS automation systems have are trained in using appropriate tools for diagnostic and forensic analysis and remediation.

Interviews and analyses conducted by the SWG indicate that, in some cases, IT support personnel who are responsible for EMS automation systems are unable to perform forensic and diagnostic routines on those systems. This appears to stem from a lack of tools, documentation and technical skills. It should be noted that some of the organizations interviewed excelled in this area but that overall performance was lacking.

In order to address the finding described above, the Task Force recommends:

- ◆ CAs and RCs seek to improve internal forensic and diagnostic capabilities as well as strengthen coordination with external EMS vendors and contractors who can assist in servicing EMS automation systems;
- ◆ CAs and RCs ensure that IT support personnel who support EMS automation systems are familiar with the systems’ design and implementation; and
- ◆ CAs and RCs ensure that IT support personnel who support EMS automation systems have access to and are trained in using appropriate

tools for diagnostic and forensic analysis and remediation.

38. Assess IT risk and vulnerability at scheduled intervals.

IT and EMS support personnel should perform regular risk and vulnerability assessment activities for automation systems (including EMS applications and underlying operating systems) to identify weaknesses, high-risk areas, and mitigating actions such as improvements in policy, procedure, and technology.

Interviews and analysis conducted by the SWG indicate that in some instances risk and vulnerability management were not being performed on EMS automation systems and their IT supporting infrastructure. To some CAs, EMS automation systems were considered “black box”⁴⁷ technologies; and this categorization removed them from the list of systems identified for risk and vulnerability assessment.

39. Develop capability to detect wireless and remote wireline intrusion and surveillance.

Both the private and public sector should promote the development of the capability of all CAs and RCs to reasonably detect intrusion and surveillance of wireless and remote wireline access points and transmissions. CAs and RCs should also conduct periodic reviews to ensure that their user base is in compliance with existing wireless and remote wireline access rules and policies.

Interviews conducted by the SWG indicate that most of the organizations interviewed had some type of wireless and remote wireline intrusion and surveillance detection protocol as a standard security policy; however, there is a need to improve and strengthen current capabilities regarding wireless and remote wireline intrusion and surveillance detection. The successful detection and monitoring of wireless and remote wireline access points and transmissions are critical to securing grid operations from a cyber security perspective.

There is also evidence that although many of the organizations interviewed had strict policies against allowing wireless network access, periodic reviews to ensure compliance with these policies were not undertaken.

40. Control access to operationally sensitive equipment.

RCs and CAs should implement stringent policies and procedures to control access to sensitive equipment and/or work areas.

Interviews conducted by the SWG indicate that at some CAs and RCs operationally sensitive computer equipment was accessible to non-essential personnel. Although most of these non-essential personnel were escorted through sensitive areas, it was determined that this procedure was not always enforced as a matter of everyday operations.

In order to address the finding described above, the Task Force recommends:

- ◆ That RCs and CAs develop policies and procedures to control access to sensitive equipment and/or work areas to ensure that:
 - Access is strictly limited to employees or contractors who utilize said equipment as part of their job responsibilities.
 - Access for other staff who need access to sensitive areas and/or equipment but are not directly involved in their operation (such as cleaning staff and other administrative personnel) is strictly controlled (via escort) and monitored.

41. NERC should provide guidance on employee background checks.

NERC should provide guidance on the implementation of its recommended standards on background checks, and CAs and RCs should review their policies regarding background checks to ensure they are adequate.

Interviews conducted with sector participants revealed instances in which certain company contract personnel did not have to undergo background check(s) as stringent as those performed on regular employees of a CA or RC. NERC Urgent Action Standard Section 1207 Paragraph 2.3 specifies steps to remediate sector weaknesses in this area but there is a need to communicate and enforce this standard by providing the industry with recommended implementation guidance, which may differ among CAs and RCs.

In order to address the finding described above, the Task Force recommends:

- ◆ NERC provide guidance on the implementation of its recommended standards on background checks, especially as they relate to the screening of contracted and sub-contracted personnel.
- ◆ CAs and RCs review their policies regarding background checks to ensure they are adequate before allowing sub-contractor personnel to access their facilities.

42. Confirm NERC ES-ISAC as the central point for sharing security information and analysis.

The NERC ES-ISAC should be confirmed as the central electricity sector point of contact for security incident reporting and analysis. Policies and protocols for cyber and physical incident reporting should be further developed including a mechanism for monitoring compliance. There also should be uniform standards for the reporting and sharing of physical and cyber security incident information across both the private and public sectors.

There are currently both private and public sector information sharing and analysis initiatives in place to address the reporting of physical and cyber security incidents within the electricity sector. In the private sector, NERC operates an Electricity Sector Information Sharing and Analysis Center (ES-ISAC) specifically to address this issue. On behalf of the U.S. Government, the Department of Homeland Security (DHS) operates the Information Analysis and Infrastructure Protection (IAIP) Directorate to collect, process, and act upon information on possible cyber and physical security threats and vulnerabilities. In Canada, Public Safety and Emergency Preparedness Canada has a 24/7 operations center for the reporting of incidents involving or impacting critical infrastructure. As well, both in Canada and the U.S., incidents of a criminal nature can be reported to law enforcement authorities of jurisdiction.

Despite these private and public physical and cyber security information sharing and analysis initiatives, an analysis of policies and procedures within the electricity sector reveals that reporting of security incidents to internal corporate security, law enforcement, or government agencies was uneven across the sector. The fact that these existing channels for incident reporting—whether security- or electricity systems-related—are currently underutilized is an operating deficiency which could hamper the industry’s ability to address future problems in the electricity sector.

Interviews and analysis conducted by the SWG further indicate an absence of coherent and effective mechanisms for the private sector to share information related to critical infrastructure with government. There was also a lack of confidence on the part of private sector infrastructure owners and grid operators that information shared with governments could be protected from disclosure under Canada’s Access to Information Act (ATIA) and the U.S. Freedom of Information Act (FOIA). On the U.S. side of the border, however, the imminent implementation of the Critical Infrastructure Information (CII) Act of 2002 should mitigate almost all industry concerns about FOIA disclosure. In Canada, Public Safety and Emergency Preparedness Canada relies on a range of mechanisms to protect the sensitive information related to critical infrastructure that it receives from its private sector stakeholders, including the exemptions for third party information that currently exist in the ATIA and other instruments. At the same time, Public Safety and Emergency Preparedness Canada is reviewing options for stronger protection of CI information, including potential changes in legislation.

In order to address the finding described above, the Task Force recommends:

- ◆ Confirmation of the NERC ES-ISAC as the central electricity sector point of contact for security incident reporting and analysis.
- ◆ Further development of NERC policies and protocols for cyber and physical incident reporting including a mechanism for monitoring compliance.
- ◆ The establishment of uniform standards for the reporting of physical and cyber security incidents to internal corporate security, private sector sector-specific information sharing and analysis bodies (including ISACs), law enforcement, and government agencies.
- ◆ The further development of new mechanisms and the promulgation of existing⁴⁸ Canadian and U.S. mechanisms to facilitate the sharing of electricity sector threat and vulnerability information across governments as well as between the private sector and governments.
- ◆ Federal, state, and provincial/territorial governments work to further develop and promulgate measures and procedures that protect critical, but sensitive, critical infrastructure-related information from disclosure.

43. Establish clear authority for physical and cyber security.

The task force recommends that corporations establish clear authority and ownership for physical and cyber security. This authority should have the ability to influence corporate decision-making and the authority to make physical and cyber security-related decisions.

Interviews and analysis conducted by the SWG indicate that some power entities did not implement best practices when organizing their security staff. It was noted at several entities that the Information System (IS) security staff reported to IT support personnel such as the Chief Information Officer (CIO).

Best practices across the IT industry, including most large automated businesses, indicate that the best way to balance security requirements properly with the IT and operational requirements of a company is to place security at a comparable level within the organizational structure. By allowing the security staff a certain level of autonomy, management can properly balance the associated risks and operational requirements of the facility.

44. Develop procedures to prevent or mitigate inappropriate disclosure of information.

The private and public sectors should jointly develop and implement security procedures and awareness training in order to mitigate or prevent disclosure of information by the practices of open source collection, elicitation, or surveillance.

SWG interviews and intelligence analysis provide no evidence of the use of open source collection, elicitation or surveillance against CAs or RCs leading up to the August 14, 2003, power outage. However, such activities may be used by malicious individuals, groups, or nation states engaged in intelligence collection in order to gain insights or proprietary information on electric power system functions and capabilities. Open source collection is difficult to detect and thus is best countered through careful consideration by industry stakeholders of the extent and nature of publicly-available information. Methods of elicitation and surveillance, by comparison, are more detectable activities and may be addressed through increased awareness and security training. In addition to prevention and detection, it is equally important that suspected or actual incidents of

these intelligence collection activities be reported to government authorities.

In order to address the findings described above, the Task Force recommends:

- ◆ The private and public sectors jointly develop and implement security procedures and awareness training in order to mitigate disclosure of information not suitable for the public domain and/or removal of previously available information in the public domain (web sites, message boards, industry publications, etc.).
- ◆ The private and public sector jointly develop and implement security procedures and awareness training in order to mitigate or prevent disclosure of information by the practices of elicitation.
- ◆ The private and public sector jointly develop and implement security procedures and awareness training in order to mitigate, prevent, and detect incidents of surveillance.
- ◆ Where no mechanism currently exists, the private and public sector jointly establish a secure reporting chain and protocol for use of the information for suspected and known attempts and incidents of elicitation and surveillance.

Group IV. Canadian Nuclear Power Sector

The U.S. nuclear power plants affected by the August 14 blackout performed as designed. After reviewing the design criteria and the response of the plants, the U.S. members of the Nuclear Working Group had no recommendations relative to the U.S. nuclear power plants.

As discussed in Chapter 8, Canadian nuclear power plants did not trigger the power system outage or contribute to its spread. Rather, they disconnected from the grid as designed. The Canadian members of the Nuclear Working Group have, therefore, no specific recommendations with respect to the design or operation of Canadian nuclear plants that would improve the reliability of the Ontario electricity grid. The Canadian Nuclear Working Group, however, made two recommendations to improve the response to future events involving the loss of off-site power, one concerning backup electrical generation equipment to the CNSC's Emergency Operations Centre and another concerning the use of adjuster rods during future events involving the loss of off-site power. The Task Force accepted

these recommendations, which are presented below.

45. The Task Force recommends that the Canadian Nuclear Safety Commission request Ontario Power Generation and Bruce Power to review operating procedures and operator training associated with the use of adjuster rods.

OPG and Bruce Power should review their operating procedures to see whether alternative procedures could be put in place to carry out or reduce the number of system checks required before placing the adjuster rods into automatic mode. This review should include an assessment of any regulatory constraints placed on the use of the adjuster rods, to ensure that risks are being appropriately managed.

Current operating procedures require independent checks of a reactor's systems by the reactor operator and the control room supervisor before the reactor can be put in automatic mode to allow the reactors to operate at 60% power levels. Alternative procedures to allow reactors to run at 60% of power while waiting for the grid to be re-established may reduce other risks to the health and safety of Ontarians that arise from the loss of a key source of electricity. CNSC oversight and approval of any changes to operating procedures would ensure that health and safety, security, or the environment are not compromised. The CNSC would assess the outcome of the proposed review to ensure that health and safety, security, and the environment would not be compromised as a result of any proposed action.

46. The Task Force recommends that the Canadian Nuclear Safety Commission purchase and install backup generation equipment.

In order to ensure that the CNSC's Emergency Operations Center (EOC) is available and fully functional during an emergency situation requiring CNSC response, whether the emergency is nuclear-related or otherwise, and that staff needed to respond to the emergency can be accommodated safely, the CNSC should have backup electrical generation equipment of sufficient capacity to provide power to the EOC, telecommunications and Information Technology (IT) systems and accommodations for the CNSC staff needed to respond to an emergency.

The August 2003 power outage demonstrated that the CNSC's Emergency Operations Center, IT, and communications equipment are vulnerable if there is a loss of electricity to the Ottawa area.

Endnotes

¹ In fairness, it must be noted that reliability organizations in some areas have worked diligently to implement recommendations from earlier blackouts. According to the *Initial Report by the New York State Department of Public Service on the August 14, 2003 Blackout*, New York entities implemented all 100 of the recommendations issued after the New York City blackout of 1977.

² The need for a systematic recommitment to reliability by all affected organizations was supported in various ways by many commenters on the *Interim Report*, including Anthony J. Alexander, FirstEnergy; David Barrie, Hydro One Networks, Inc.; Joseph P. Carson, P.E.; Harrison Clark; F. J. Delea, J.A. Casazza, G.C. Loehr, and R. M. Malizewski, Power Engineers Seeking Truth; Ajay Garg and Michael Penstone, Hydro One Networks, Inc.; and Raymond K. Kershaw, International Transmission Company.

³ See supporting comments expressed by Anthony J. Alexander, FirstEnergy; Deepak Divan, SoftSwitching Technologies; Pierre Guimond, Canadian Nuclear Association; Hans Konow, Canadian Electricity Association; Michael Penstone, Hydro One Networks, Inc.; and James K. Robinson, PPL.

⁴ See "The Economic Impacts of the August 2003 Blackout," Electric Consumers Resource Council (ELCON), February 2, 2004.

⁵ The need for action to make standards enforceable was supported by many commenters, including David Barrie, Hydro One Networks, Inc.; Carl Burrell, IMO Ontario; David Cook, North American Electric Reliability Council; Deepak Divan, SoftSwitching Technologies; Charles J. Durkin, Northeast Power Coordinating Council; David Goffin, Canadian Chemical Producers' Association; Raymond K. Kershaw, International Transmission Company; Hans Konow, Canadian Electricity Association; Barry Lawson, National Rural Electric Cooperative Association; William J. Museler, New York Independent System Operator; Eric B. Stephens, Ohio Consumers' Counsel; Gordon Van Welie, ISO New England, Inc.; and C. Dortch Wright, on behalf of James McGreevey, Governor of New Jersey.

⁶ This recommendation was suggested by some members of the Electric System Working Group.

⁷ The need to evaluate and where appropriate strengthen the institutional framework for reliability management was supported in various respects by many commenters, including Anthony J. Alexander, FirstEnergy Corporation; David Barrie, Hydro One Networks, Inc.; Chris Booth, Experienced Consultants LLC; Carl Burrell, IMO Ontario; Linda Campbell, Florida Reliability Coordinating Council; Linda Church Ciocci, National Hydropower Association; David Cook, NERC; F.J. Delea, J.A. Casazza, G.C. Loehr, and R.M. Malizewski, Power Engineers Seeking Truth; Charles J. Durkin, Northeast Power Coordinating Council; Ajay Garg and Michael Penstone, Hydro One Networks, Inc.; Michael W. Golay, Massachusetts Institute of Technology; Leonard S. Hyman, Private Sector Advisors, Inc; Marija Ilic, Carnegie Mellon University; Jack Kerr, Dominion Virginia Power; Raymond K. Kershaw,

International Transmission Company; Paul Kleindorfer, University of Pennsylvania; Michael Kormos, PJM Interconnection; Bill Mittelstadt, Bonneville Power Administration; William J. Museler, New York Independent System Operator; James K. Robinson, PPL; Eric B. Stephens, Ohio Consumers' Counsel; John Synesiou, IMS Corporation; Gordon Van Welie, ISO New England; Vickie Van Zandt, Bonneville Power Administration; and C. Dortch Wright, on behalf of James McGreevey, Governor of New Jersey.

⁸ Several commenters noted the importance of clarifying that prudently incurred reliability expenses and investments will be recoverable through regulator-approved rates. These commenters include Anthony J. Alexander, FirstEnergy Corporation; Deepak Divan, SoftSwitching Technologies; Stephen Fairfax, MTechnology, Inc.; Michael W. Golay, Massachusetts Institute of Technology; Pierre Guimond, Canadian Nuclear Association; Raymond K. Kershaw, International Transmission Company; Paul R. Kleindorfer, University of Pennsylvania; Hans Konow, Canadian Electricity Association; Barry Lawson, National Rural Electric Cooperative Association; and Michael Penstone, Hydro One Networks, Inc.

⁹ The concept of an ongoing NERC process to track the implementation of existing and subsequent recommendations was initiated by NERC and broadened by members of the Electric System Working Group. See comments by David Cook, North American Electric Reliability Council.

¹⁰ This recommendation was suggested by NERC and supported by members of the Electric System Working Group.

¹¹ See comments by Jack Kerr, Dominion Virginia Power, and Margie Phillips, Pennsylvania Services Integration Consortium.

¹² The concept of a "reliability impact consideration" was suggested by NERC and supported by the Electric System Working Group.

¹³ The suggestion that EIA should become a source of reliability data and information came from a member of the Electric System Working Group.

¹⁴ Several commenters raised the question of whether there was a linkage between the emergence of competition (or increased wholesale electricity trade) in electricity markets and the August 14 blackout. See comments by Anthony J. Alexander, FirstEnergy Corporation; F.J. Delea, J.A. Casazza, G.C. Loehr, and R.M. Malizewski, Power Engineers Seeking Truth; Ajay Garg and Michael Penstone, Hydro One Networks, Inc.; Brian O'Keefe, Canadian Union of Public Employees; Les Pereira; and John Wilson.

¹⁵ NIMBY: "Not In My Back Yard."

¹⁶ Several commenters either suggested that government agencies should expand their research in reliability-related topics, or emphasized the need for such R&D more generally. See comments by Deepak Divan, SoftSwitching Technologies; Marija Ilic, Carnegie Mellon University; Hans Konow, Canadian Electricity Association; Stephen Lee, Electric Power Research Institute; James K. Robinson, PPL; John Synesiou, IMS Corporation; and C. Dortch Wright on behalf of Governor James McGreevey of New Jersey.

¹⁷ The concept of a standing framework for grid-related investigations was initiated by members of the Electric System Working Group, after noting that the U.S. National Aeronautics and Space Administration (NASA) had created a similar arrangement after the *Challenger* explosion in 1986. This framework was put to use immediately after the loss of the shuttle *Columbia* in 2003.

¹⁸ This subject was addressed in detail in comments by David Cook, North American Electric Reliability Council; and in part by comments by Anthony J. Alexander, FirstEnergy Corporation; Ajay Garg, Hydro One Networks, Inc.; George Katsuras, IMO Ontario; and Vickie Van Zandt, Bonneville Power Administration.

¹⁹ U.S. Federal Energy Regulatory Commission, 105 FERC ¶ 61,372, December 24, 2003.

²⁰ See ECAR website, http://www.ecar.org/documents/document%201_6-98.pdf.

²¹ See NERC website, <http://www.nerc.com/standards/>.

²² The need to ensure better maintenance of required electrical clearances in transmission right of way areas was emphasized by several commenters, including Richard E. Abbott, arborist; Anthony J. Alexander, FirstEnergy Corporation; David Barrie, Hydro One Networks, Inc.; David Cook, North American Electric Reliability Council; Ajay Garg and Michael Penstone, Hydro One Networks, Inc.; Tadashi Mano, Tokyo Electric Power Company; Eric B. Stephens, Ohio Consumers' Counsel; Vickie Van Zandt, Bonneville Power Administration; and Donald Wightman, Utility Workers Union of America.

²³ *Utility Vegetation Management Final Report*, CN Utility Consulting, LLC, March 2004, commissioned by the U.S. Federal Energy Regulatory Commission to support the investigation of the August 14, 2003 blackout.

²⁴ The need to strengthen and verify compliance with NERC standards was noted by several commenters. See comments by David Barrie, Hydro One Networks, Inc.; Carl Burrell, IMO Ontario; David Cook, North American Electric Reliability Council; and Eric B. Stephens, Ohio Consumers' Counsel.

²⁵ The need to verify application of NERC standards via readiness audits—before adverse incidents occur—was noted by several commenters. See comments by David Barrie, Hydro One Networks, Inc.; David Cook, North American Electric Reliability Council; Barry Lawson, National Rural Electric Cooperative Association; Bill Mittelstadt, Bonneville Power Administration; and Eric B. Stephens, Ohio Consumers' Counsel.

²⁶ The need to improve the training and certification requirements for control room management and staff drew many comments. See comments by David Cook, North American Electric Reliability Council; F.J. Delea, J.A. Casazza, G.C. Loehr, and R.M. Malizewski, Power Engineers Seeking Truth; Victoria Dountchenko, MPR Associates; Pat Duran, IMO Ontario; Ajay Garg and Michael Penstone, Hydro One Networks, Inc.; George Katsuras, IMO Ontario; Jack Kerr, Dominion Virginia Power; Tim Kucey, National Energy Board, Canada; Stephen Lee, Electric Power Research Institute; Steve Leovy, personal comment; Ed Schwerdt, Northeast Power Coordinating Council; Tapani O. Seppa, The Valley Group, Inc.; Eric B. Stephens, Ohio Consumers' Counsel; Vickie Van Zandt, Bonneville Power Company; Don Watkins, Bonneville Power Administration; and Donald Wightman, Utility Workers Union of America.

²⁷ This reliance, and the risk of an undue dependence, is often unrecognized in the industry.

²⁸ Many parties called for clearer statement of the roles, responsibilities, and authorities of control areas and reliability coordinators, particularly in emergency situations. See comments by Anthony J. Alexander, FirstEnergy Corporation; Chris Booth, Experienced Consultants LLC; Michael Calimano, New York ISO; Linda Campbell, Florida Reliability Coordinating Council; David Cook, North American Electric

Reliability Council; F.J. Delea, J.A. Casazza, G.C. Loehr, and R.M. Malizewski, Power Engineers Seeking Truth; Mark Fidrych, Western Area Power Authority; Ajay Garg and Michael Penstone, Hydro One Networks, Inc.; Carl Hauser, Washington State University; Stephen Kellat; Jack Kerr, Dominion Virginia Power; Raymond K. Kershaw, International Transmission Company; Michael Kormos, PJM Interconnection; William J. Museler, New York Independent System Operator; Tapani O. Seppa, The Valley Group, Inc.; John Synesiou, IMS Corporation; Gordon Van Welie, ISO New England, Inc.; Vickie Van Zandt, Bonneville Power Administration; Kim Warren, IMO Ontario; and Tom Wiedman, Consolidated Edison. Members of the Electric System Working Group initiated the concept of defining an “alert” status, between “normal” and “emergency,” and associated roles, responsibilities, and authorities.

²⁹ The need to make better use of system protection measures received substantial comment, including comments by James L. Blasiak, International Transmission Company; David Cook, North American Electric Reliability Council; Charles J. Durkin, Northeast Power Coordinating Council; F.J. Delea, J.A. Casazza, G.C. Loehr, and R.M. Malizewski, Power Engineers Seeking Truth; Ajay Garg and Michael Penstone, Hydro One Networks, Inc.; Gurgen and Spartak Hakobyan, personal study; Marija Ilic, Carnegie Mellon University; Shinichi Imai, Tokyo Electric Power Company; Jack Kerr, Dominion Virginia Power; Stephen Lee, Electric Power Research Institute; Ed Schwerdt, Northeast Power Coordinating Council; Robert Stewart, PG&E; Philip Tatro, National Grid Company; Carson Taylor, Bonneville Power Administration; Vickie Van Zandt, Bonneville Power Company; Don Watkins, Bonneville Power Administration; and Tom Wiedman, Consolidated Edison.

³⁰ The subject of developing and adopting better real-time tools for control room operators and reliability coordinators drew many comments, including those by Anthony J. Alexander, FirstEnergy Corporation; Eric Allen, New York ISO; Chris Booth, Experienced Consultants, LLC; Mike Calimano, New York ISO; Claudio Canizares, University of Waterloo (Ontario); David Cook, North American Electric Reliability Council; Deepak Divan, SoftSwitching Technologies Victoria Doumtchenko, MPR Associates; Pat Duran, IMO Ontario; Bill Eggertson, Canadian Association for Renewable Energies; Ajay Garg and Michael Penstone, Hydro One Networks, Inc.; Jack Kerr, Dominion Virginia Power; Raymond K. Kershaw, International Transmission Company; Michael Kormos, PJM Interconnection; Tim Kucey, National Energy Board, Canada; Steve Lapp, Lapp Renewables; Stephen Lee, Electric Power Research Institute; Steve Leovy; Tom Levy; Peter Love, Canadian Energy Efficiency Alliance; Frank Macedo, Hydro One Networks, Inc.; Bill Mittelstadt, Bonneville Power Administration; Fiona Oliver, Canadian Energy Efficiency Alliance; Peter Ormund, Mohawk College; Don Ross, Prince Edward Island Wind Co-op Limited; James K. Robinson, PPL; Robert Stewart, PG&E; John Synesiou, IMS Corporation; Gordon Van Welie, ISO New England, Inc.; Vickie Van Zandt, Bonneville Power Administration; Don Watkins, Bonneville Power Administration; Chris Winter, Conservation Council of Ontario; David Zwergel, Midwest ISO. The concept of requiring annual testing and certification of operators’ EMS and SCADA systems was initiated by a member of the Electric System Working Group. Also, see comments by John Synesiou, IMS Corporation.

³¹ The need to strengthen reactive power and voltage control practices was the subject of several comments. See comments by Claudio Canizares, University of Waterloo (Ontario); David Cook, North American Electric Reliability Council; F.J.

Delea, J.A. Casazza, G.C. Loehr, and R.M. Malizewski, Power Engineers Seeking Truth; Stephen Fairfax, MTEchnology, Inc.; Ajay Garg and Michael Penstone, Hydro One Networks, Inc.; Shinichi Imai and Toshihiko Furuya, Tokyo Electric Power Company; Marija Ilic, Carnegie Mellon University; Frank Macedo, Hydro One Networks, Inc.; and Tom Wiedman, Consolidated Edison. Several commenters addressed issues related to the production of reactive power by producers of power for sale in wholesale markets. See comments by Anthony J. Alexander, FirstEnergy Corporation; K.K. Das, PowerGrid Corporation of India, Limited; F.J. Delea, J.A. Casazza, G.C. Loehr, and R.M. Malizewski, Power Engineers Seeking Truth; Stephen Fairfax, MTEchnology, Inc.; and Carson Taylor, Bonneville Power Administration.

³² See pages 107-108.

³³ U.S. Federal Energy Regulatory Commission, 105 FERC ¶ 61,372, December 24, 2003.

³⁴ The need to improve the quality of system modeling data and data exchange practices received extensive comment. See comments from Michael Calimano, New York ISO; David Cook, North American Electric Reliability Council; Robert Cummings, North American Electric Reliability Council; F.J. Delea, J.A. Casazza, G.C. Loehr, and R.M. Malizewski, Power Engineers Seeking Truth; Mark Fidrych, Western Area Power Administration; Jack Kerr, Dominion Virginia Power; Raymond K. Kershaw, International Transmission Company; Frank Macedo, Hydro One Networks, Inc.; Vickie Van Zandt, Bonneville Power Administration; Don Watkins, Bonneville Power Administration; and David Zwergel, Midwest ISO.

³⁵ Several commenters addressed the subject of NERC’s standards in various respects, including Anthony J. Alexander, FirstEnergy Corporation; Carl Burrell, IMO Ontario; David Cook, North American Electric Reliability Council; F.J. Delea, J.A. Casazza, G.C. Loehr, and R.M. Malizewski, Power Engineers Seeking Truth; Charles J. Durkin, Northeast Power Coordinating Council; Ajay Garg and Michael Penstone, Hydro One Networks, Inc.; Jack Kerr, Dominion Virginia Power; James K. Robinson, PPL; Mayer Sasson, New York State Reliability Council; and Kim Warren, IMO Ontario.

³⁶ See *Initial Report by the New York State Department of Public Service on the August 14, 2003 Blackout* (2004), and comments by Mayer Sasson, New York State Reliability Council.

³⁷ F.J. Delea, J.A. Casazza, G.C. Loehr, and R.M. Malizewski, “The Need for Strong Planning and Operating Criteria to Assure a Reliable Bulk Power Supply System,” January 29, 2004.

³⁸ The need to tighten communications protocols and improve communications systems was cited by several commenters. See comments by Anthony J. Alexander, FirstEnergy Corporation; David Barrie, Hydro One Networks, Inc.; Carl Burrell, IMO Ontario; Michael Calimano, New York ISO; David Cook, North American Electric Reliability Council; Mark Fidrych, Western Area Power Administration; Ajay Garg and Michael Penstone, Hydro One Networks, Inc.; Jack Kerr, Dominion Virginia Power; William Museler, New York ISO; John Synesiou, IMS Corporation; Vickie Van Zandt, Bonneville Power Administration; Don Watkins, Bonneville Power Administration; Tom Wiedman, Consolidated Edison.

³⁹ See comments by Tapani O. Seppa, The Valley Group, Inc.

⁴⁰ Several commenters noted the need for more systematic use of time-synchronized data recorders. In particular, see David Cook, North American Electric Reliability Council; Ajay Garg and Michael Penstone, Hydro One Networks, Inc.; and Robert Stewart, PG&E.

⁴¹ The importance of learning from the system restoration experience associated with the August 14 blackout was stressed by Linda Church Ciocci, National Hydropower Association; David Cook, North American Electric Reliability Council; Frank Delea; Bill Eggertson, Canadian Association for Renewable Energies; Stephen Lee, Electric Power Research Institute; and Kim Warren, IMO Ontario.

⁴² The need to clarify the criteria for identifying critical facilities and improving dissemination of updated information about unplanned outages was cited by Anthony J. Alexander, FirstEnergy Corporation; and Raymond K. Kershaw, International Transmission Company.

⁴³ The need to streamline the TLR process and limit the use of it to non-urgent situations was discussed by several commenters, including Anthony J. Alexander, FirstEnergy Corporation; Carl Burrell, IMO Ontario; Jack Kerr, Dominion Virginia Power; Raymond K. Kershaw, International Transmission Company; and Ed Schwerdt, Northeast Power Coordinating Council.

⁴⁴ NERC Standards at www.nerc.com (Urgent Action Standard 1200, Cyber Security, Reliability Standard 1300, Cyber Security) and Joint DOE/PCIB standards guidance at www.ea.doe.gov/pdfs/21stepsbooklet.pdf (“21 Steps to Improve Cyber Security of SCADA Networks”).

⁴⁵ For example: “21 Steps to Improve Cyber Security of SCADA Networks,” <http://www.ea.doe.gov/pdfs/21stepsbooklet.pdf>.

⁴⁶ Canadian reference: <http://www.dfait-maeci.gc.ca/anti-terrorism/actionplan-en.asp>; U.S. reference: <http://www.whitehouse.gov/news/releases/2001/12/20011212-6.html>.

⁴⁷ A “black box” technology is any device, sometimes highly important, whose workings are not understood by or accessible to its user.

⁴⁸ DOE Form 417 is an example of an existing, but underutilized, private/public sector information sharing mechanism.

Appendix A

Members of the U.S.-Canada Power System Outage Task Force and Its Three Working Groups

Task Force Co-Chairs

Spencer Abraham, Secretary of the U.S. Department of Energy (USDOE)

R. John Efford, Canadian Minister of Natural Resources (current) and **Herb Dhaliwal** (August-December 2003)

Canadian Task Force Members

Linda J. Keen, President and CEO of the Canadian Nuclear Safety Commission

Anne McLellan, Deputy Prime Minister and Minister of Public Safety and Emergency Preparedness

John Manley, (previous) Deputy Prime Minister and Minister of Finance

Kenneth Vollman, Chairman of the National Energy Board

U.S. Task Force Members

Nils J. Diaz, Chairman of the Nuclear Regulatory Commission

Tom Ridge, Secretary of the U.S. Department of Homeland Security (DHS)

Pat Wood, III, Chairman of the Federal Energy Regulatory Commission (FERC)

Principals Managing the Working Groups

Jimmy Glotfelty, Director, Office of Electric Transmission and Distribution, USDOE

Dr. Nawal Kamel, Special Advisor to the Deputy Minister of Natural Resources Canada (NRCan)

Working Groups

Electric System Working Group

Co-Chairs

David Meyer, Senior Advisor, Office of Electric Transmission and Distribution, USDOE (U.S. Government)

Thomas Rusnov, Senior Advisor, Natural Resources Canada (Government of Canada)

Alison Silverstein, Senior Energy Policy Advisor to the Chairman, FERC (U.S. Government)

Canadian Members

David Barrie, Senior Vice President, Asset Management, Hydro One

David Burpee, Director, Renewable and Electrical Energy Division, NRCan (Government of Canada)

David McFadden, Chair, National Energy and Infrastructure Industry Group, Gowling, Lafleur, Henderson LLP (Ontario)

U.S. Members

Donald Downes, Public Utility Commission Chairman (Connecticut)

Joseph H. Eto, Staff Scientist, Ernest Orlando Lawrence Berkeley National Laboratory, Consortium for Electric Reliability Technology Solutions (CERTS)

Jeanne M. Fox, President, New Jersey Board of Public Utilities (New Jersey)

H. Kenneth Haase, Sr. Vice President, Transmission, New York Power Authority (New York)

J. Peter Lark, Chairman, Public Service Commission (Michigan)

Blaine Loper, Senior Engineer, Pennsylvania Public Utility Commission (Pennsylvania)

William McCarty, Chairman, Indiana Utility Regulatory Commission (Indiana)

David O'Brien, Vermont Public Service Department, Commissioner (Vermont)

David O'Connor, Commissioner, Division of Energy Resources, Office of Consumer Affairs and Business Regulation (Massachusetts)

Alan Schriber, Public Utility Commission Chairman (Ohio)

Gene Whitney, Policy Analyst, Office of Science and Technology Policy (U.S. Government)

Security Working Group

Co-Chairs

William J.S. Elliott, Assistant Secretary to the Cabinet, Security and Intelligence, Privy Council Office (Government of Canada)

Robert Liscouski, Assistant Secretary for Infrastructure, Department of Homeland Security (U.S. Government)

Canadian Members

Curt Allen, Director Corporate Security, Management Board Secretariat, Office of the Corporate Chief Information Officer, Government of Ontario

Gary Anderson, Chief, Counter-Intelligence-Global, Canadian Security Intelligence Service (Government of Canada)

Michael Devancy, Deputy Chief, Information Technology Security, Communications Security Establishment (Government of Canada)

James Harlick, Assistant Deputy Minister, Public Safety and Emergency Preparedness Canada (Government of Canada)

Peter MacAulay, Officer in Charge of Technological Crime Branch, Royal Canadian Mounted Police (Government of Canada)

Ralph Mahar, Chief, Technical Operations, Scientific and Technical Services, Canadian Security Intelligence Service (Government of Canada)

Dr. James Young, Commissioner of Public Security, Ontario Ministry of Public Safety and Security (Ontario)

U.S. Members

Sid Casperson, Director, Office of Counter Terrorism (New Jersey)

Vincent DeRosa, Deputy Commissioner, Director of Homeland Security, Department of Public Safety (Connecticut)

Harold M. Hendershot, Acting Section Chief, Computer Intrusion Section, Federal Bureau of Investigation (U.S. Government)

Kevin Kolevar, Chief of Staff to the Deputy Secretary of Energy, Department of Energy (U.S. Government)

Paul Kurtz, Special Assistant to the President and Senior Director for Critical Infrastructure

Protection, Homeland Security Council (U.S. Government)

James McMahon, Senior Advisor (New York)

Colonel Michael C. McDaniel, Assistant Adjutant General for Homeland Security (Michigan)

John Overly, Executive Director, Division of Homeland Security (Ohio)

Andy Purdy, Deputy Director, National Cyber Security Division, Information Analysis and Infrastructure Protection Directorate, DHS

Kerry L. Sleeper, Commissioner, Public Safety (Vermont)

Arthur Stephens, Deputy Secretary for Information Technology, Office of Administration (Pennsylvania)

Steve Schmidt, Section Chief, Special Technologies and Applications, FBI

Richard Swensen, Under Secretary, Office of Public Safety and Homeland Security (Massachusetts)

Simon Szykman, Senior Policy Analyst, Office of Science and Technology Policy (U.S. Government)

Nuclear Working Group

Co-Chairs

Nils Diaz, Chairman, Nuclear Regulatory Commission (U.S. Government)

Linda J. Keen, President and Chief Executive Officer, Canadian Nuclear Safety Commission (Government of Canada)

Canadian Members

James Blyth, Director General, Directorate of Power Regulation, Canadian Nuclear Safety Commission (Government of Canada)

Duncan Hawthorne, Chief Executive Officer, Bruce Power (Ontario)

Robert Morrison, Senior Advisor to the Deputy Minister, Natural Resources Canada (Government of Canada)

Ken Pereira, Vice President, Operations Branch, Canadian Nuclear Safety Commission (Government of Canada)

U.S. Members

David J. Allard, CHP, Director, Bureau of Radiation Protection Department of Environmental Protection (Pennsylvania)

Frederick F. Butler, Commissioner, New Jersey Board of Public Utilities (New Jersey)

Sam J. Collins, Deputy Executive Director for Reactor Programs, Nuclear Regulatory Commission

Paul Eddy, Power Systems Operations Specialist, Public Service Commission (New York)

J. Peter Lark, Chairman, Public Service Commission (Michigan)

William D. Magwood IV, Director, Office of Nuclear Energy, Science and Technology, Department of Energy (U.S. Government)

Dr. G. Ivan Moldonado, Associate Professor, Mechanical, Industrial and Nuclear Engineering; University of Cincinnati (Ohio)

David O'Brien, Commissioner, Department of Public Service (Vermont)

David O'Connor, Commissioner, Division of Energy Resources, Office of Consumer Affairs and Business Regulation (Massachusetts)

Gene Whitney, Policy Analyst, National Science and Technology Policy, Executive Office of the President (U.S. Government)

Edward Wilds, Bureau of Air Management, Department of Environmental Protection (Connecticut)

This report reflects tireless efforts by hundreds of individuals not identified by name above. They include electrical engineers, information technology experts, and other specialists from across the North American electricity industry, the academic world, regulatory agencies in the U.S. and Canada, the U.S. Department of Energy and its national laboratories, the U.S. Department of Homeland Security, the U.S. Federal Bureau of Investigation, Natural Resources Canada, the Royal Canadian Mounted Police, the Bonneville Power Administration, the Western Area Power Administration, the Tennessee Valley Authority, the North American Electric Reliability Council, PJM Interconnection, Inc., Ontario's Independent Market Operator, and many other organizations. The members of the U.S.-Canada Power System Outage Task Force thank these individuals, and congratulate them for their dedication and professionalism.

Appendix B

Description of Outage Investigation and Process for Development of Recommendations

On August 14, 2003, the northeastern U.S. and Ontario, Canada, suffered one of the largest power blackouts in the history of North America. The area affected extended from New York, Massachusetts, and New Jersey west to Michigan, and from Ohio north to Ontario, Canada.

President George W. Bush and Prime Minister Jean Chrétien created a U.S.-Canada Task Force to identify the causes of the power outage and to develop recommendations to prevent and contain future outages. U.S. Energy Secretary Spencer Abraham and Minister of Natural Resources Canada Herb Dhaliwal, meeting in Detroit, Michigan, on August 20, agreed on an outline for the activities of the Task Force.

This appendix outlines the process used for the determination of why the blackout occurred and was not contained and explains how recommendations were developed to prevent and minimize the scope of future outages. Phase I of the process was completed when the Interim Report, identifying what happened and why, was released on November 19, 2003. This Final Report, released on April 5, 2004, completes Phase II of the process by providing recommendations acceptable to both countries for preventing and reducing the scope of future blackouts. This report, which encompasses both the findings of the Interim Report and updated information from continued analysis by the investigative teams, totally supersedes the Interim Report.

During Phase II, the Task Force sought the views of the public and expert stakeholders in Canada and the U.S. towards the development of the final recommendations. People were asked to comment on the Interim Report and provide their views on recommendations to enhance the reliability of the electric system in each country. The Task Force collected this information by several methods, including public forums, workshops of technical experts, and electronic submissions to the NRCAN and DOE web sites.

Verbatim transcripts of the forums and workshops were provided on-line, on both the NRCAN and DOE web sites. In Canada, which operates in both English and French, comments were posted in the

language in which they were submitted. Individuals who either commented on the Interim Report, provided suggestions for recommendations to improve reliability, or both are listed in Appendix C. Their input was greatly appreciated. Their comments can be viewed in full or in summary at <http://www.nrcan.gc.ca> or at <http://www.electricity.doe.gov>.

Task Force Composition and Responsibilities

The co-chairs of the Task Force were U.S. Secretary of Energy Spencer Abraham and Minister of Natural Resources Canada (NRCAN) Herb Dhaliwal for Phase I and Minister of NRCAN R. John Efford for Phase II. Other U.S. members were Nils J. Diaz, Chairman of the Nuclear Regulatory Commission, Tom Ridge, Secretary of Homeland Security, and Pat Wood III, Chairman of the Federal Energy Regulatory Commission. The other Canadian members were Deputy Prime Minister John Manley during Phase I and Anne McLellan, Deputy Prime Minister and Minister of Public Safety and Emergency Preparedness during Phase II, Linda J. Keen, President and CEO of the Canadian Nuclear Safety Commission, and Kenneth Vollman, Chairman of the National Energy Board. The coordinators for the Task Force were Jimmy Glotfelty on behalf of the U.S. Department of Energy and Dr. Nawal Kamel on behalf of Natural Resources Canada.

On August 27, 2003, Secretary Abraham and Minister Dhaliwal announced the formation of three Working Groups to support the work of the Task Force. The three Working Groups addressed electric system issues, security matters, and questions related to the performance of nuclear power plants over the course of the outage. The members of the Working Groups were officials from relevant federal departments and agencies, technical experts, and senior representatives from the affected states and the Province of Ontario.

U.S.-Canada-NERC Investigation Team

Under the oversight of the Task Force, three investigative teams of electric system, nuclear and

cyber and security experts were established to investigate the causes of the outage. The electric system investigative team was comprised of individuals from several U.S. federal agencies, the U.S. Department of Energy's national laboratories, Canadian electric industry, Canada's National Energy Board, staff from the North American Electric Reliability Council (NERC), and the U.S. electricity industry. The overall investigative team was divided into several analytic groups with specific responsibilities, including data management, determining the sequence of outage events, system modeling, evaluation of operating tools and communications, transmission system performance, generator performance, NERC and regulatory standards/procedures and compliance, system planning and design studies, vegetation and right-of-way management, transmission and reliability investments, and root cause analysis.

Additional teams of experts were established to address issues related to the performance of nuclear power plants affected by the outage, and physical and cyber security issues related to the bulk power infrastructure. The security and nuclear investigative teams also had liaisons who worked closely with the various electric system investigative teams mentioned above.

Function of the Working Groups

The U.S. and Canadian co-chairs of each of the three Working Groups (i.e., an Electric System Working Group, a Nuclear Working Group, and a Security Working Group) designed investigative assignments to be completed by the investigative teams. These findings were synthesized into a single Interim Report reflecting the conclusions of the three investigative teams and the Working Groups. For Phase II, the Interim Report was enhanced with new information gathered from the technical conferences, additional modeling and analysis and public comments. Determination of when the Interim and Final Reports were complete and appropriate for release to the public was the responsibility of the U.S.-Canada Task Force and the investigation co-chairs.

Confidentiality of Data and Information

Given the seriousness of the blackout and the importance of averting or minimizing future blackouts, it was essential that the Task Force's teams have access to pertinent records and data from the regional transmission operators (RTOs) and independent system operators (ISOs) and

electric companies affected by the blackout, and data from the nuclear and security associated entities. The investigative teams also interviewed appropriate individuals to learn what they saw and knew at key points in the evolution of the outage, what actions they took, and with what purpose. In recognition of the sensitivity of this information, Working Group members and members of the teams signed agreements affirming that they would maintain the confidentiality of data and information provided to them, and refrain from independent or premature statements to the media or the public about the activities, findings, or conclusions of the individual Working Groups or the Task Force as a whole.

After publication of the Interim Report, the Task Force investigative teams continued to evaluate the data collected during Phase I. Continuing with Phase I criteria, confidentiality was maintained in Phase II, and all investigators and working group members were asked to refrain from independent or premature statements to the media or the public about the activities, findings, or conclusions of the individual Working Groups or the Task Force as a whole.

Relevant U.S. and Canadian Legal Framework

United States

The Secretary of Energy directed the Department of Energy (DOE) to gather information and conduct an investigation to examine the cause or causes of the August 14, 2003 blackout. In initiating this effort, the Secretary exercised his authority under section 11 of the Energy Supply and Environmental Coordination Act of 1974, and section 13 of the Federal Energy Administration Act of 1974, to gather energy-related information and conduct investigations. This authority gives him and the DOE the ability to collect such energy information as he deems necessary to assist in the formulation of energy policy, to conduct investigations at reasonable times and in a reasonable manner, and to conduct physical inspections at energy facilities and business premises. In addition, DOE can inventory and sample any stock of fuels or energy sources therein, inspect and copy records, reports, and documents from which energy information has been or is being compiled and to question such persons as it deems necessary. DOE worked closely with Natural Resources Canada and NERC on the investigation.

Canada

Minister Dhaliwal, as the Minister responsible for Natural Resources Canada, was appointed by Prime Minister Chrétien as the Canadian Co-Chair of the Task Force. Minister Dhaliwal worked closely with his American Co-Chair, Secretary of Energy Abraham, as well as NERC and his provincial counterparts in carrying out his responsibilities. When NRCan Minister R. John Efford assumed his role as the new Canadian Co-Chair, he continued to work closely with Secretary Abraham and the three Working Groups.

Under Canadian law, the Task Force was characterized as a non-statutory, advisory body that does not have independent legal personality. The Task Force did not have any power to compel evidence or witnesses, nor was it able to conduct searches or seizures. In Canada, the Task Force relied on voluntary disclosure for obtaining information pertinent to its work.

Oversight and Coordination

The Task Force's U.S. and Canadian coordinators held frequent conference calls to ensure that all components of the investigation were making timely progress. They briefed both Secretary Abraham and Minister R. John Efford (Minister Dhaliwal, Phase I) regularly and provided weekly summaries from all components on the progress of the investigation. During part of Phase I, the leadership of the electric system investigation team held daily conference calls to address analytical and process issues important to the investigation. The three Working Groups held weekly conference calls to enable the investigation teams to update the Working Group members on the state of the overall analysis. Conference calls also focused on the analysis updates and the need to ensure public availability of all inputs to the development of recommendations. Working Group members attended panels and face-to-face meetings to review drafts of the report.

Electric System Investigation Phase I Investigative Process

Collection of Data and Information from ISOs, Utilities, States, and the Province of Ontario

On Tuesday, August 19, 2003, investigators affiliated with the U.S. Department of Energy (DOE) began interviewing control room operators and other key officials at the ISOs and the companies most directly involved with the initial stages of the outage. In addition to the information gained in

the interviews, the interviewers sought information and data about control room operations and practices, the organization's system status and conditions on August 14, the organization's operating procedures and guidelines, load limits on its system, emergency planning and procedures, system security analysis tools and procedures, and practices for voltage and frequency monitoring. Similar interviews were held later with staff at Ontario's Independent Electricity Market Operator (IMO) and Hydro One in Canada.

On August 22 and 26, NERC directed the reliability coordinators at the ISOs to obtain a wide range of data and information from the control area coordinators under their oversight. The data requested included System Control and Data Acquisition (SCADA) logs, Energy Management System (EMS) logs, alarm logs, data from local digital fault recorders, data on transmission line and generator "trips" (i.e., automatic disconnection to prevent physical damage to equipment), state estimator data, operator logs and transcripts, and information related to the operation of capacitors, phase shifting transformers, load shedding, static var compensators, special protection schemes or stability controls, and high-voltage direct current (HVDC) facilities. NERC issued another data request to FirstEnergy on September 15 for copies of studies since 1990 addressing voltage support, reactive power supply, static capacitor applications, voltage requirements, import or transfer capabilities (in relation to reactive capability or voltage levels), and system impacts associated with unavailability of the Davis-Besse plant. All parties were instructed that data and information provided to either DOE or NERC did not have to be submitted a second time to the other entity—all material provided would go into a common data base.

For the Interim Report the investigative team held three technical conferences (August 22, September 8-9, and October 1-3) with the RTOs and ISOs and key utilities aimed at clarifying the data received, filling remaining gaps in the data, and developing a shared understanding of the data's implications.

Data "Warehouse"

The data collected by the investigative team was organized in an electronic repository containing thousands of transcripts, graphs, generator and transmission data and reports at the NERC headquarters in Princeton, New Jersey. The warehouse contains more than 20 gigabytes of information, in

more than 10,000 files. This established a set of validated databases that the analytic teams could access as needed.

Individual investigative teams conducted their activities through a number of in-person meetings as well as conference calls and e-mail communications over the months of the investigation. Detailed investigative team findings will be included in upcoming technical reports issued by NERC.

The following were the information sources for the Electric System Investigation:

- ◆ Interviews conducted by members of the U.S.-Canada Electric Power System Outage Investigation Team with personnel at all of the utilities, control areas and reliability coordinators in the weeks following the blackout.
- ◆ Three fact-gathering meetings conducted by the Investigation Team with personnel from the above organizations on August 22, September 8 and 9, and October 1 to 3, 2003.
- ◆ Three public hearings held in Cleveland, Ohio; New York City, New York; and Toronto, Ontario.
- ◆ Two technical conferences held in Philadelphia, Pennsylvania, and Toronto, Canada.
- ◆ Materials provided by the above organizations in response to one or more data requests from the Investigation Team.
- ◆ All taped phone transcripts between involved operations centers.
- ◆ Additional interviews and field visits with operating personnel on specific issues in October 2003 and January 2004.
- ◆ Field visits to examine transmission lines and vegetation at short-circuit locations.
- ◆ Materials provided by utilities and state regulators in response to data requests on vegetation management issues.
- ◆ Detailed examination of thousands of individual relay trips for transmission and generation events.

Data Exploration and Requirements

This group requested data from the following control areas and their immediate neighbors: MISO, MECS, FE, PJM, NYISO, ISO-NE, and IMO. The data and exploration and requirements group's

objective was to identify industry procedures that are in place today for collecting information following large-scale transmission related power outages and to assess those procedures in terms of the August 14, 2003 power outage investigation.

They sought to:

- ◆ Determine what happened in terms of immediate causes, sequence of events, and resulting consequences;
- ◆ Understand the failure mechanism via recordings of system variables such as frequency, voltages, and flows;
- ◆ Enable disturbance re-creation using computer models for the purposes of understanding the mechanism of failure, identifying ways to avoid or mitigate future failures, and assessing and improving the integrity of computer models;
- ◆ Identify deeper, underlying factors contributing to the failure (e.g., general policies, standard practices, communication paths, organizational cultures).

Sequence of Events

More than 800 events occurred during the blackout of August 14. The events included the opening and closing of transmission lines and associated breakers and switches, the opening of transformers and associated breakers, and the tripping and starting of generators and associated breakers. Most of these events occurred in the few minutes of the blackout cascade between 16:06 and 16:12 EDT. To properly analyze a blackout of this magnitude, an accurate knowledge of the sequence of events must be obtained before any analysis of the blackout can be performed.

Establishing a precise and accurate sequence of outage-related events was a critical building block for the other parts of the investigation. One of the key problems in developing this sequence was that although much of the data pertinent to an event was time-stamped, there was variation from source to source in how the time-stamping was done, and not all of the time-stamps were synchronized to the National Institute of Standards and Technology (NIST) standard clock in Boulder, CO. Validating the timing of specific events became a large, important, and sometimes difficult task. This work was also critical to the issuance by the Task Force on September 12 of a "timeline" for the outage. The timeline briefly described the principal events, in sequence, leading up to the initiation of the outage's cascade phase, and then in the

cascade itself. The timeline was not intended, however, to address the causal relationships among the events described, or to assign fault or responsibility for the blackout. All times in the chronology are in Eastern Daylight Time.

System Modeling and Simulation Analysis

The system modeling and simulation team (SMST) replicated system conditions on August 14 and the events leading up to the blackout. The modeling reflects the state of the electric system. Once benchmarked to actual conditions at selected critical times on August 14, it allowed analysts to conduct a series of sensitivity studies to determine if the system was stable and within limits at each point in time leading up to the cascade. The analysis also confirmed when the system became unstable and allowed analysts to test whether measures such as load-shedding would have prevented the cascade.

This team consisted of a number of NERC staff and persons with expertise in areas necessary to read and interpret all of the data logs, digital fault recorder information, sequence of events recorders information, etc. The team consisted of about 40 people involved at various different times with additional experts from the affected areas to understand the data.

Overall, this team:

- ◆ Created steady-state power flow cases for observed August 14 system conditions starting at 15:00 EDT through about 16:05 EDT (when powerflow simulations were no longer adequate), about the time of the Sammis-Star 345-kV outage.
- ◆ Compiled relevant data for dynamic modeling of affected systems (e.g. generator dynamic models, load characteristics, special protection schemes, etc.).
- ◆ Performed rigorous contingency analysis (over 800 contingencies in Eastern Interconnection run) to determine if the system was within operating within thermal and voltage limits, and within limits for possible further contingencies (N-1 contingencies) prior to and during the initial events of the blackout sequence.
- ◆ Performed sensitivity analysis to determine the significance of pre-existing conditions such as transmission outages in Cinergy and Dayton, and the earlier loss of Eastlake unit 5 generation.
- ◆ Performed “what-if” analysis to determine potential impacts of remedial actions such as

reclosing of outages facilities during the sequence of events, load shedding, generation redispatch, and combinations of load shedding and redispatch.

- ◆ Compared transaction tags for August 14, to show how they matched up with those of other days in 2003 and 2002.
- ◆ Analyzed the transactions and generation dispatch changes used to bring replacement power for the loss of Eastlake 5 generation into FirstEnergy, to determine where the replacement power came from.
- ◆ Analyzed the performance of the Interchange Distribution Calculator (IDC) and its potential capability to help mitigate the overloads.

The SMST began its efforts using the base case data and model provided by FirstEnergy as its foundation.

The modeling and system studies work was performed under the guidance of a specially formed MAAC-ECAR-NPCC (MEN) Coordinating Group, consisting of the Regional Managers from those three regions impacted by the blackout, and their respective regional chairmen or designees.

Assessment of Operations Tools, SCADA/EMS, Communications, and Operations Planning

The Operations Tools, SCADA/EMS, Communications, and Operations Planning Team assessed the observability of the electric system to operators and reliability coordinators, and the availability and effectiveness of operational (real-time and day-ahead) reliability assessment tools, including redundancy of views and the ability to observe the “big picture” regarding bulk electric system conditions. The team investigated operating practices and effectiveness of operating entities and reliability coordinators in the affected area. This team investigated all aspects of the blackout related to operator and reliability coordinator knowledge of system conditions, action or inactions, and communications.

The Operations and Tools team conducted extensive interviews with operating personnel at the affected facilities. They participated in the technical investigation meetings with affected operators in August, September and October and reviewed the August 14 control room transcripts in detail. This group investigated the performance of the MISO and FirstEnergy EMS hardware and software and its impact on the blackout, and looked at operator training (including the use of formal versus “on-the-job” training) and the

communications and interactions between the operations and information technology support staff at both organizations.

Frequency/ACE Analysis

The Frequency/ACE Team analyzed potential frequency anomalies that may have occurred on August 14, as compared to typical interconnection operations. The team also determined whether there were any unusual issues with control performance and frequency and any effects they may have had related to the cascading failure, and whether frequency-related anomalies were contributing factors or symptoms of other problems leading to the cascade.

Assessment of Transmission System Performance, Protection, Control, Maintenance, and Damage

This team investigated the causes of all transmission facility automatic operations (trips and reclosings) leading up to and through to the end of the cascade on all facilities greater than 100 kV. Included in the review were relay protection and remedial action schemes, including under-frequency load-shedding and identification of the cause of each operation and any misoperations that may have occurred. The team also assessed transmission facility maintenance practices in the affected area as compared to good utility practice and identified any transmission equipment that was damaged as a result of the cascading outage. The team reported patterns and conclusions regarding what caused transmission facilities to trip; why did the cascade extend as far as it did and not further into other systems; any misoperations and the effect those misoperations had on the outage; and any transmission equipment damage. Also the team reported on the transmission facility maintenance practices of entities in the affected area compared to good utility practice.

Assessment of Generator Performance, Protection, Controls, Maintenance, and Damage

This team investigated the cause of generator trips for all generators with a 10 MW or greater nameplate rating leading to and through the end of the cascade. The review included the cause for the generator trips, relay targets, unit power runbacks, and voltage/reactive power excursions. The team reported any generator equipment that was damaged as a result of the cascading outage. The team

reported on patterns and conclusions regarding what caused generation facilities to trip. The team identified any unexpected performance anomalies or unexplained events. The team assessed generator maintenance practices in the affected area as compared to good utility practice. The team analyzed the coordination of generator under-frequency settings with transmission settings, such as under-frequency load shedding. The team gathered and analyzed data on affected nuclear units and worked with the Nuclear Regulatory Commission to address U.S. nuclear unit issues.

The Generator Performance team sent out an extensive data request to generator owners during Phase I of the investigation, but did not receive the bulk of the responses until Phase II. The analysis in this report uses the time of generator trip as it was reported by the plant owner, or the time when the generator ceased feeding power into the grid as determined by a system monitoring device, and synchronized those times to other known grid events as best as possible. However, many generation owners offered little information on the cause of unit trips or key information on conditions at their units, so it may never be possible to fully determine what happened to all the generators affected by the blackout, and why they performed as they did. In particular, it is not clear what point in time each reported generator trip time reflects—i.e., when in the cycle between when the generator first detected the condition which caused it to trip, or several seconds later when it actually stopped feeding power into the grid. This lack of clear data hampered effective investigation of generator issues.

Vegetation Management

For Phase I the Vegetation/Right of Way Team conducted a field investigation into the contacts that occurred between trees and conductors on August 14 within the FirstEnergy, Dayton Power & Light and Cinergy service areas. The team also examined detailed information gained from data requests to these and other utilities, including historical outages from tree contacts on these lines. These findings were included in the Interim Report and detailed in an interim report on utility vegetation management, posted at <http://www.ferc.gov/cust-protect/moi/uvm-initial-report.pdf>.

The team also requested information from the public utility commissions in the blackout area on any state requirements for transmission vegetation management and right-of-way maintenance.

Beginning in Phase I and continuing into Phase II, the Vegetation/ROW team looked in detail at the vegetation management and ROW maintenance practices for the three utilities above, and compared them to accepted utility practices across North America. Issues examined included ROW legal clearance agreements with landowners, budgets, tree-trimming cycles, organization structure, and use of herbicides. Through CN Utility Consulting, the firm hired by FERC to support the blackout investigation, the Vegetation/ROW team also identified “best practices” for transmission ROW management. They used those practices to evaluate the performance of the three utilities involved in August 14 line outages and also to evaluate the effectiveness of utility vegetation management practices generally.

On March 2, 2004, FERC released CN Utility Consulting’s “Utility Vegetation Management Final Report” (see <http://www.ferc.gov/cust-protect/moi/uvm-final-report.pdf>).

Root Cause Analysis

The investigation team used a technique called root cause analysis to help guide the overall investigation process in an effort to identify root causes and contributing factors leading to the start of the blackout in Ohio. The root cause analysis team worked closely with the technical investigation teams providing feedback and queries on additional information. Also, drawing on other data sources as needed, the root cause analysis verified facts regarding conditions and actions (or inactions) that contributed to the blackout.

Root cause analysis is a systematic approach to identifying and validating causal linkages among conditions, events, and actions (or inactions) leading up to a major event of interest—in this case the August 14 blackout. It has been successfully applied in investigations of events such as nuclear power plant incidents, airplane crashes, and the recent Columbia space shuttle disaster.

Root cause analysis is driven by facts and logic. Events and conditions that may have helped to cause the major event in question are described in factual terms, and causal linkages are established between the major event and earlier conditions or events. Such earlier conditions or events are examined in turn to determine their causes, and at each stage the investigators ask whether the particular condition or event could have developed or occurred if a proposed cause (or combination of causes) had not been present. If the particular

event being considered could have occurred without the proposed cause (or combination of causes), the proposed cause or combination of causes is dropped from consideration and other possibilities are considered.

Root cause analysis typically identifies several or even many causes of complex events; each of the various branches of the analysis is pursued until either a “root cause” is found or a non-correctable condition is identified. (A condition might be considered as non-correctable due to existing law, fundamental policy, laws of physics, etc.). Sometimes a key event in a causal chain leading to the major event could have been prevented by timely action by one or another party; if such action was feasible, and if the party had a responsibility to take such action, the failure to do so becomes a root cause of the major event.

Phase II

On December 12, 2003, Paul Martin was elected as the new Prime Minister of Canada and assumed responsibility for the Canadian section of the Power System Outage Task Force. Prime Minister Martin appointed R. John Efford as the new Minister of Natural Resources Canada and co-chair of the Task Force.

Press releases, a U.S. Federal Register notice, and ads in the Canadian press notified the public and stakeholders of Task Force developments. All public statements were released to the media and are available on the OETD and the NRCAN web sites.

Several of the investigative teams began their work during Phase I and completed it during Phase II. Other teams could not begin their investigation into the events related to the cascade and blackout, beginning at 16:05:57 EDT on August 14, 2003, until analysis of the Ohio events before that point was completed in Phase I.

System Planning, Design and Studies Team

The SPDST studied reactive power management, transactions scheduling, system studies and system operating limits for the Ohio and ECAR areas. In addition to the data in the investigation data warehouse, the team submitted six comprehensive data requests to six control areas and reliability coordinators, including FirstEnergy, to build the foundation for its analyses. The team examined reactive power and voltage management policies, practices and criteria and compared them to actual and modeled system conditions in the

affected area and neighboring systems. They assessed the process of assessing and approving transaction schedules and tags and the coordination of those schedules and transactions in August, 2003, and looked at the impact of tagged transactions on key facilities on August 14. Similarly, the team examined system operating limits in effect for the affected area on August 14, how they had been determined, and whether they were appropriate to the grid as it existed in August 2003. They reviewed system studies conducted by FirstEnergy and ECAR for 2003 and prior years, including the methodologies and assumptions used in those studies and how those were coordinated across adjoining control areas and councils. The SPDST also compared how the studied conditions compared to actual conditions on August 14. For all these matters, the team compared the policies, studies and practices to good utility practices.

The SPDST worked closely with the Modeling and System Simulation Team. They used data provided by the control areas, RTOs and ISOs on actual system conditions across August 2003, and NERC Tag Dump and TagNet data. To do the voltage analyses, the team started with the MSST's base case data and model of the entire Eastern Interconnection, then used a more detailed model of the FE area provided by FirstEnergy. With these models they conducted extensive PV and VQ analyses for different load levels and contingency combinations in the Cleveland-Akron area, running over 10,000 different power flow simulations. Team members have extensive experience and expertise in long-term and operational planning and system modeling.

NERC Standards, Procedures and Compliance Team

The SP&C team was charged with reviewing the NERC Operating Policies and Planning Standards for any violations that occurred in the events leading up to and during the blackout, and assessing the sufficiency or deficiency of NERC and regional reliability standards, policies and procedures. They were also directed to develop and conduct audits to assess compliance with the NERC and regional reliability standards as relevant to the cause of the outage.

The team members, all experienced participants in the NERC compliance and auditing program, examined the findings of the Phase I investigation in detail, building particularly upon the root cause

analysis. They looked independently into many issues, conducting additional interviews as needed. The team distinguished between those violations which could be clearly proven and those which were problematic but not fully provable. The SP&C team offered a number of conclusions and recommendations to improve operational reliability, NERC standards, the standards development process and the compliance program.

Dynamic Modeling of the Cascade

This work was conducted as an outgrowth of the work done by the System Modeling and Simulation team in Phase I, by a team composed of the NPCC System Studies-38 Working Group on Inter-Area Dynamic Analysis, augmented by representatives from ECAR, MISO, PJM and SERC. Starting with the steady-state power flows developed in Phase I, they moved the analysis forward across the Eastern Interconnection from 16:05:50 EDT on in a series of first steady-state, then dynamic simulations to understand how conditions changed across the grid.

This team is using the model to conduct a series of "what if" analyses, to better understand what conditions contributed to the cascade and what might have happened if events had played out differently. This work is described further within Chapter 6.

Additional Cascade Analysis

The core team for the cascade investigation drew upon the work of all the teams to understand the cascade after 16:05:57. The investigation's official Sequence of Events was modified and corrected as appropriate as additional information came in from asset owners, and as modeling and other investigation revealed inaccuracies in the initial data reports. The team issued additional data requests and looked closely at the data collected across the period of the cascade. The team organized the analysis by attempting to link the individual area and facility events to the power flows, voltages and frequency data recorded by Hydro One's PSDRs (as seen in Figures 6.16 and 6.25) and similar data sets collected elsewhere. This effort improved the team's understanding of the interrelationships between the interaction, timing and impacts of lines, loads and generation trips, which are now being confirmed by dynamic modeling. Graphing, mapping and other visualization tools also created insights into the cascade, as with the revelation of the role of zone 3 relays in

accelerating the early spread of the cascade within Ohio and Michigan.

The team was aided in its work by the ability to learn from the studies and reports on the blackout completed by various groups outside the investigation, including those by the Public Utility Commission of Ohio, the Michigan Public Service Commission, the New York ISO, ECAR and the Public Service Commission of New York.

Beyond the work of the Electric System investigation, the Security and Nuclear investigation teams conducted additional analyses and updated their interim reports with the additional findings.

Preparation of Task Force Recommendations

Public and stakeholder input was an important component in the development of the Task Force's recommendations. The input received covered a wide range of subjects, including enforcement of reliability standards, improving communications, planning for responses to emergency conditions, and the need to evaluate market structures. See Appendix C for a list of contributors.

Three public forums and two technical conferences were held to receive public comments on the Interim Report and suggested recommendations for consideration by the Task Force. These events were advertised by various means, including announcements in the *Federal Register* and the *Canada Gazette*, advertisements in local newspapers in the U.S., invitations to industry through NERC, invitations to the affected state and provincial regulatory bodies, and government press releases. All written inputs received at these meetings and conferences were posted for

additional comment on public websites maintained by the U.S. Department of Energy and Natural Resources Canada (www.electricity.doe.gov and www.nrcan.gc.ca, respectively). The transcripts from the meetings and conferences were also posted on these websites.

- ◆ Members of all three Working Groups participated in public forums in Cleveland, Ohio (December 4, 2003), New York City (December 5, 2003), and Toronto, Ontario (December 8, 2003).
- ◆ The ESWG held two technical conferences, in Philadelphia, Pennsylvania (December 16, 2003), and Toronto, Ontario (January 9, 2004).
- ◆ The NWG also held a public meeting on nuclear-related issues pertaining to the blackout at the U.S. Nuclear Regulatory Commission headquarters in Rockville, Maryland (January 6, 2004).

The electric system investigation team also developed an extensive set of technical findings based on team analyses and cross-team discussions as the Phase I and Phase II work progressed. Many of these technical findings were reflected in NERC's actions and initiatives of February 10, 2004. In turn, NERC's actions and initiatives received significant attention in the development of the Task Force's recommendations.

The SWG convened in January 2004 in Ottawa to review the Interim Report. The SWG also held virtual meetings with the investigative team leads and working group members.

Similarly, the ESWG conducted weekly telephone conferences and it held face-to-face meetings on January 30, March 3, and March 18, 2004.

Appendix C

List of Commenters

The individuals listed below either commented on the Interim Report, provided suggestions for recommendations to improve reliability, or both. Their input was greatly appreciated. Their comments can be viewed in full or in summary at <http://www.nrcan.gc.ca> or at <http://www.electricity.doe.gov>.

Abbott, Richard E.	Personal comment
Adams, Tom	Energy Probe
Akerlund, John	Uninterruptible Power Networks UPN AB
Alexander, Anthony J.	FirstEnergy
Allen, Eric	New York ISO
Barrie, David	Hydro One
Benjamin, Don	North American Electric Reliability Council (NERC)
Besich, Tom	Electric power engineer
Blasiak, James L.	DykemaGossett PLLC for International Transmission Company (ITC)
Booth, Chris	Experienced Consultants LLC
Boschmann, Armin	Manitoba Hydro
Brown, Glenn W.	New Brunswick Power Corp; NPCC Representative & Chairman, NERC Disturbance Analysis Working Group
Burke, Thomas J.	Orion Associates International, Inc.
Burrell, Carl	IMO Ontario
Bush, Tim	Consulting
Calimano, Michael	New York ISO
Cañizares, Claudio A.	University of Waterloo, Ontario Canada
Carpentier, Philippe	French grid operator
Carson, Joseph P.	Personal comment
Casazza, J. A.	Power Engineers Seeking Truth
Chen, Shihe	Power Systems Business Group, CLP Power Hong Kong Ltd.
Church, Bob	Management Consulting Services, Inc.
Clark, Harrison	Harrison K. Clark
Cook, David	NERC
Cummings, Bob	Director of Reliability Assessments and Support Services, NERC
Das, K K	IEEE member, PowerGrid Corporation of India Limited
Delea, F. J.	Power Engineers Seeking Truth
Delea, Frank	ConEdison
Divan, Deepak	Soft Switching Technologies
Doumtchenko, Victoria	MPR Associates
Duran, Pat	IMO Ontario
Durkin, Charles J.	Northeast Power Coordinating Council (NPCC)
Eggertson, Bill	Canadian Association for Renewable Energies

Fernandez, Rick	Personal comment
Fidrych, Mark	Western Area Power Authority (WAPA) and Chairman of the NERC Operating Committee
Furuya, Toshihiko	Tokyo Electric Power Co., Inc.
Galatic, Alex	Personal comment
Garg, Ajay	Hydro One Networks Inc.
Goffin, Dave	Canadian Chemical Producers Association
Gruber, William M. Ondrey	Attorney
Guimond, Pierre	Canadian Nuclear Association
Gurdziel, Tom	Personal comment
Hakobyan, Spartak and Gurgun	Personal comment
Han, Masur	Personal comment
Hauser, Carl	School of Electrical Engineering and Computer Science, Washington State University
Hebert, Larry	Thunder Bay Hydro
Hilt, Dave	NERC
Hughes, John P.	ELCON
Imai, Shinichi	Tokyo Electric Power
Jeyapalan, Jey K.	Jeyapalan & Associates, LLC
Johnston, Sidney A.	Personal comment
Kane, Michael	Personal comment
Katsuras, George	Independent Electric Market Operator of Ontario
Kellat, Stephen	Personal comment
Kerr, Jack	Dominion Virginia Power
Kerr, Jack	Best Real-time Reliability Analysis Practices Task Force
Kershaw, Raymond K.	International Transmission Company
Kolodziej, Eddie	Personal comment
Konow, Hans	Canadian Electricity Association
Kormos, Mike	PJM
Kucey, Tim	National Energy Board (Canada)
Laugier, Alexandre	Personal comment
Lawson, Barry	National Rural Electric Cooperative Association
Lazarewicz, Matthew L.	Beacon Power Corp.
Lee, Stephen	Electric Power Research Institute
Leovy, Steve	Personal comment
Linda Campbell	Florida Reliability Coordinating Council
Loehr, G.C.	Power Engineers Seeking Truth
Love, Peter	Canadian Energy Efficiency Alliance
Macedo, Frank	Hydro One
Maliszewski, R.M.	Power Engineers Seeking Truth
McMonagle, Rob	Canadian Solar Industries Association
Meissner, Joseph	Personal comment

Middlestadt, Bill	Bonneville Power Administration
Milner, Carolyn	Cuyahoga County Board of Commissioners, and member, Community Advisory Panel; panel created for Cleveland Electric Illuminating Co. (later First Energy)
Mitchell, Terry	Excel Energy
Moore, Scott	AEP
Murphy, Paul	IMO Ontario
Museler, William J.	New York Independent System Operator
O'Keefe, Brian	Canadian Union of Public Employees
Oliver, Fiona	Canadian Energy Efficiency Alliance
Ormund, Peter	Mohawk College
Pennstone, Mike	Hydro One
Pereira, Les	Personal comment
Phillips, Margie	Pennsylvania Services Integration Consortium
Rocha, Paul X.	CenterPoint Energy
Ross, Don	Prince Edward Island Wind Co-Op
Rupp, Douglas B	Ada Core Technologies, Inc.
Sasson, Mayer	New York State Reliability Council
Schwerdt, Ed	Northeast Power Coordinating Council
Seppa, Tapani O.	The Valley Group, Inc.,
Silverstein, Alison	Federal Energy Regulatory Commission
Spears, J.	Personal comment
Spencer, Sidney	Personal comment
spider	Personal comment
Staniford, Stuart	Personal comment
Stephens, Eric B.	Ohio Consumers' Counsel (OCC)
Stewart, Bob	PG&E
Synesiou, John	IMS Corporation
Tarler, Howard A.	On behalf of Chairman William M. Flynn, New York State Department of Public Service
Tatro, Phil	National Grid Company
Taylor, Carson	Bonneville Power Administration
van Welie, Gordon	ISO New England Inc.
Van Zandt, Vickie	Bonneville Power Administration
Warren, Kim	IMO Ontario
Watkins, Don	Bonneville Power Administration
Wells, Chuck	OSISoft
Wiedman, Tom	ConEd
Wightman, Donald	Utility Workers Union of America
Wilson, John	Personal comment
Winter, Chris	Conservation Council of Ontario
Wright, C. Dortch	On behalf of New Jersey Governor James E. McGreevey
Zwergel, Dave	Midwest ISO

Appendix D

NERC Actions to Prevent and Mitigate the Impacts of Future Cascading Blackouts

Preamble

The Board of Trustees recognizes the paramount importance of a reliable bulk electric system in North America. In consideration of the findings of the investigation into the August 14, 2003 blackout, NERC must take firm and immediate actions to increase public confidence that the reliability of the North American bulk electric system is being protected.

A key finding of the blackout investigators is that violations of existing NERC reliability standards contributed directly to the blackout. Pending enactment of federal reliability legislation creating a framework for enforcement of mandatory reliability standards, and with the encouragement of the Stakeholders Committee, the board is determined to obtain full compliance with all existing and future reliability standards and intends to use all legitimate means available to achieve that end. The board therefore resolves to:

- *Receive specific information on all violations of NERC standards, including the identities of the parties involved;*
- *Take firm actions to improve compliance with NERC reliability standards;*
- *Provide greater transparency to violations of standards, while respecting the confidential nature of some information and the need for a fair and deliberate due process; and*
- *Inform and work closely with the Federal Energy Regulatory Commission and other applicable federal, state, and provincial regulatory authorities in the United States, Canada, and Mexico as needed to ensure public interests are met with respect to compliance with reliability standards.*

The board expresses its appreciation to the blackout investigators and the Steering Group for their objective and thorough work in preparing a report of recommended NERC actions. With a few clarifications, the board approves the report and directs implementation of the recommended actions. The board holds the assigned committees and organizations accountable to report to the board the progress in completing the recommended actions, and intends itself to publicly report those results. The board recognizes the possibility that this action plan may have to be adapted as additional analysis is completed, but stresses the need to move forward immediately with the actions as stated.

Furthermore, the board directs management to immediately advise the board of any significant violations of NERC reliability standards, including details regarding the nature and potential reliability impacts of the alleged violations and the identity of parties involved. Management shall supply to the board in advance of board meetings a detailed report of all violations of reliability standards.

Finally, the board resolves to form a task force to develop guidelines for the board to consider with regard to the confidentiality of compliance information and disclosure of such information to regulatory authorities and the public.

Approved by the Board of Trustees
February 10, 2004

1

Overview of Investigation Conclusions

The North American Electric Reliability Council (NERC) has conducted a comprehensive investigation of the August 14, 2003 blackout. The results of NERC's investigation contributed significantly to the U.S./Canada Power System Outage Task Force's November 19, 2003 Interim Report identifying the root causes of the outage and the sequence of events leading to and during the cascading failure. NERC fully concurs with the conclusions of the Interim Report and continues to provide its support to the Task Force through ongoing technical analysis of the outage. Although an understanding of what happened and why has been resolved for most aspects of the outage, detailed analysis continues in several areas, notably dynamic simulations of the transient phases of the cascade and a final verification of the full scope of all violations of NERC and regional reliability standards that occurred leading to the outage.

From its investigation of the August 14 blackout, NERC concludes that:

- Several entities violated NERC operating policies and planning standards, and those violations contributed directly to the start of the cascading blackout.
- The existing process for monitoring and assuring compliance with NERC and regional reliability standards was shown to be inadequate to identify and resolve specific compliance violations before those violations led to a cascading blackout.
- Reliability coordinators and control areas have adopted differing interpretations of the functions, responsibilities, authorities, and capabilities needed to operate a reliable power system.
- Problems identified in studies of prior large-scale blackouts were repeated, including deficiencies in vegetation management, operator training, and tools to help operators better visualize system conditions.
- In some regions, data used to model loads and generators were inaccurate due to a lack of verification through benchmarking with actual system data and field testing.
- Planning studies, design assumptions, and facilities ratings were not consistently shared and were not subject to adequate peer review among operating entities and regions.
- Available system protection technologies were not consistently applied to optimize the ability to slow or stop an uncontrolled cascading failure of the power system.

Approved by the Board of Trustees
February 10, 2004

2

Overview of Recommendations

The Board of Trustees approves the NERC Steering Group recommendations to address these shortcomings. The recommendations fall into three categories.

Actions to Remedy Specific Deficiencies: Specific actions directed to First Energy (FE), the Midwest Independent System Operator (MISO), and the PJM Interconnection, LLC (PJM) to correct the deficiencies that led to the blackout.

1. Correct the Direct Causes of the August 14, 2003 Blackout.

Strategic Initiatives: Strategic initiatives by NERC and the regional reliability councils to strengthen compliance with existing standards and to formally track completion of recommended actions from August 14, and other significant power system events.

2. Strengthen the NERC Compliance Enforcement Program.
3. Initiate Control Area and Reliability Coordinator Reliability Readiness Audits.
4. Evaluate Vegetation Management Procedures and Results.
5. Establish a Program to Track Implementation of Recommendations.

Technical Initiatives: Technical initiatives to prevent or mitigate the impacts of future cascading blackouts.

6. Improve Operator and Reliability Coordinator Training
7. Evaluate Reactive Power and Voltage Control Practices.
8. Improve System Protection to Slow or Limit the Spread of Future Cascading Outages.
9. Clarify Reliability Coordinator and Control Area Functions, Responsibilities, Capabilities and Authorities.
10. Establish Guidelines for Real-Time Operating Tools.
11. Evaluate Lessons Learned During System Restoration.
12. Install Additional Time-Synchronized Recording Devices as Needed.
13. Reevaluate System Design, Planning and Operating Criteria.
14. Improve System Modeling Data and Data Exchange Practices.

Market Impacts

Many of the recommendations in this report have implications for electricity markets and market participants, particularly those requiring reevaluation or clarification of NERC and regional standards, policies and criteria. Implicit in these recommendations is that the NERC board charges the Market Committee with assisting in the implementation of the recommendations and interfacing with the North American Energy Standards Board with respect to any necessary business practices.

Approved by the Board of Trustees
February 10, 2004

3

Recommendation to Remedy Specific Deficiencies

Recommendation 1. Correct the Direct Causes of the August 14, 2003 Blackout.

NERC's technical analysis of the August 14 blackout leads it to fully concur with the Task Force Interim Report regarding the direct causes of the blackout. The report stated that the principal causes of the blackout were that FE did not maintain situational awareness of conditions on its power system and did not adequately manage tree growth in its transmission rights-of-way. Contributing factors included ineffective diagnostic support provided by MISO as the reliability coordinator for FE and ineffective communications between MISO and PJM.

NERC will take immediate and firm actions to ensure that the same deficiencies that were directly causal to the August 14 blackout are corrected. These steps are necessary to assure electricity customers, regulators and others with an interest in the reliable delivery of electricity that the power system is being operated in a manner that is safe and reliable, and that the specific causes of the August 14 blackout have been identified and fixed.

Recommendation 1a: FE, MISO, and PJM shall each complete the remedial actions designated in Attachment A for their respective organizations and certify to the NERC board no later than June 30, 2004, that these specified actions have been completed. Furthermore, each organization shall present its detailed plan for completing these actions to the NERC committees for technical review on March 23-24, 2004, and to the NERC board for approval no later than April 2, 2004.

Recommendation 1b: The NERC Technical Steering Committee shall immediately assign a team of experts to assist FE, MISO, and PJM in developing plans that adequately address the issues listed in Attachment A, and other remedial actions for which each entity may seek technical assistance.

Approved by the Board of Trustees
February 10, 2004

4

Strategic Initiatives to Assure Compliance with Reliability Standards and to Track Recommendations

Recommendation 2. Strengthen the NERC Compliance Enforcement Program.

NERC's analysis of the actions and events leading to the August 14 blackout leads it to conclude that several violations of NERC operating policies contributed directly to an uncontrolled, cascading outage on the Eastern Interconnection. NERC continues to investigate additional violations of NERC and regional reliability standards and expects to issue a final report of those violations in March 2004.

In the absence of enabling legislation in the United States and complementary actions in Canada and Mexico to authorize the creation of an electric reliability organization, NERC lacks legally sanctioned authority to enforce compliance with its reliability rules. However, the August 14 blackout is a clear signal that voluntary compliance with reliability rules is no longer adequate. NERC and the regional reliability councils must assume firm authority to measure compliance, to more transparently report significant violations that could risk the integrity of the interconnected power system, and to take immediate and effective actions to ensure that such violations are corrected.

Violations of NERC standards identified in the November 19, 2003 Interim Report:

1. Following the outage of the Chamberlin-Harding 345 kV line, FE did not take the necessary actions to return the system to a safe operating state within 30 minutes (violation of NERC Operating Policy 2).
2. FE did not notify other systems of an impending system emergency (violation of NERC Operating Policy 5).
3. FE's analysis tools were not used to effectively assess system conditions (violation of NERC Operating Policy 5).
4. FE operator training was inadequate for maintaining reliable conditions (violation of NERC Operating Policy 8).
5. MISO did not notify other reliability coordinators of potential problems (violation of NERC Operating Policy 9).

Recommendation 2a: Each regional reliability council shall report to the NERC Compliance Enforcement Program within one month of occurrence all significant¹ violations of NERC operating policies and planning standards and regional standards, whether verified or still under investigation. Such reports shall confidentially note details regarding the nature and potential reliability impacts of the alleged violations and the identity of parties involved. Additionally, each regional reliability council shall report quarterly to NERC, in a format prescribed by NERC, all violations of NERC and regional reliability council standards.

Recommendation 2b: Being presented with the results of the investigation of any significant violation, and with due consideration of the surrounding facts and circumstances, the NERC board shall require an offending organization to correct the violation within a specified time. If the board determines that an offending organization is non-responsive and continues to cause a risk to the reliability of the interconnected power systems, the board will seek to remedy the violation by requesting assistance of the appropriate regulatory authorities in the United States, Canada, and Mexico.

¹ Although all violations are important, a significant violation is one that could directly reduce the integrity of the interconnected power systems or otherwise cause unfavorable risk to the interconnected power systems. By contrast, a violation of a reporting or administrative requirement would not by itself generally be considered a significant violation.

Recommendation 2c: The Planning and Operating Committees, working in conjunction with the Compliance Enforcement Program, shall review and update existing approved and draft compliance templates applicable to current NERC operating policies and planning standards; and submit any revisions or new templates to the board for approval no later than March 31, 2004. To expedite this task, the NERC President shall immediately form a Compliance Template Task Force comprised of representatives of each committee. The Compliance Enforcement Program shall issue the board-approved compliance templates to the regional reliability councils for adoption into their compliance monitoring programs.

This effort will make maximum use of existing approved and draft compliance templates in order to meet the aggressive schedule. The templates are intended to include all existing NERC operating policies and planning standards but can be adapted going forward to incorporate new reliability standards as they are adopted by the NERC board for implementation in the future.

When the investigation team's final report on the August 14 violations of NERC and regional standards is available in March, it will be important to assess and understand the lapses that allowed violations to go unreported until a large-scale blackout occurred.

Recommendation 2d: The NERC Compliance Enforcement Program and ECAR shall, within three months of the issuance of the final report from the Compliance and Standards investigation team, evaluate the identified violations of NERC and regional standards, as compared to previous compliance reviews and audits for the applicable entities, and develop recommendations to improve the compliance process.

Recommendation 3. Initiate Control Area and Reliability Coordinator Reliability Readiness Audits.

In conducting its investigation, NERC found that deficiencies in control area and reliability coordinator capabilities to perform assigned reliability functions contributed to the August 14 blackout. In addition to specific violations of NERC and regional standards, some reliability coordinators and control areas were deficient in the performance of their reliability functions and did not achieve a level of performance that would be considered acceptable practice in areas such as operating tools, communications, and training. In a number of cases there was a lack of clarity in the NERC policies with regard to what is expected of a reliability coordinator or control area. Although the deficiencies in the NERC policies must be addressed (see Recommendation 9), it is equally important to recognize that standards cannot prescribe all aspects of reliable operation and that minimum standards present a threshold, not a target for performance. Reliability coordinators and control areas must perform well, particularly under emergency conditions, and at all times strive for excellence in their assigned reliability functions and responsibilities.

Approved by the Board of Trustees
February 10, 2004

6

Recommendation 3a: The NERC Compliance Enforcement Program and the regional reliability councils shall jointly establish a program to audit the reliability readiness of all reliability coordinators and control areas, with immediate attention given to addressing the deficiencies identified in the August 14 blackout investigation. Audits of all control areas and reliability coordinators shall be completed within three years and continue in a three-year cycle. The 20 highest priority audits, as determined by the Compliance Enforcement Program, will be completed by June 30, 2004.

Recommendation 3b: NERC will establish a set of baseline audit criteria to which regional criteria may be added. The control area requirements will be based on the existing NERC Control Area Certification Procedure. Reliability coordinator audits will include evaluation of reliability plans, procedures, processes, tools, personnel qualifications, and training. In addition to reviewing written documents, the audits will carefully examine the actual practices and preparedness of control areas and reliability coordinators.

Recommendation 3c: The reliability regions, with the oversight and direct participation of NERC, will audit each control area's and reliability coordinator's readiness to meet these audit criteria. FERC and other relevant regulatory agencies will be invited to participate in the audits, subject to the same confidentiality conditions as the other members of the audit teams.

Recommendation 4. Evaluate Vegetation Management Procedures and Results.

Ineffective vegetation management was a major cause of the August 14 blackout and also contributed to other historical large-scale blackouts, such on July 2-3, 1996 in the west. Maintaining transmission line rights-of-way (ROW), including maintaining safe clearances of energized lines from vegetation, under-build, and other obstructions² incurs a substantial ongoing cost in many areas of North America. However, it is an important investment for assuring a reliable electric system.

NERC does not presently have standards for ROW maintenance. Standards on vegetation management are particularly challenging given the great diversity of vegetation and growth patterns across North America. However, NERC's standards do require that line ratings are calculated so as to maintain safe clearances from all obstructions. Furthermore, in the United States, the National Electrical Safety Code (NESC) Rules 232, 233, and 234 detail the minimum vertical and horizontal safety clearances of overhead conductors from grounded objects and various types of obstructions. NESC Rule 218 addresses tree clearances by simply stating, "Trees that may interfere with ungrounded supply conductors should be trimmed or removed." Several states have adopted their own electrical safety codes and similar codes apply in Canada.

Recognizing that ROW maintenance requirements vary substantially depending on local conditions, NERC will focus attention initially on measuring performance as indicated by the number of high voltage line trips caused by vegetation rather than immediately move toward developing standards for

² Vegetation, such as the trees that caused the initial line trips in FE that led to the August 14, 2003 outage is not the only type of obstruction that can breach the safe clearance distances from energized lines. Other examples include under-build of telephone and cable TV lines, train crossings, and even nests of certain large bird species.

ROW maintenance. This approach has worked well in the Western Electricity Coordinating Council (WECC) since being instituted after the 1996 outages.

Recommendation 4a: NERC and the regional reliability councils shall jointly initiate a program to report all bulk electric system³ transmission line trips resulting from vegetation contact⁴. The program will use the successful WECC vegetation monitoring program as a model.

Recommendation 4b: Beginning with an effective date of January 1, 2004, each transmission operator will submit an annual report of all vegetation-related high voltage line trips to its respective reliability region. Each region shall assemble a detailed annual report of vegetation-related line trips in the region to NERC no later than March 31 for the preceding year, with the first reporting to be completed by March 2005 for calendar year 2004.

Vegetation management practices, including inspection and trimming requirements, can vary significantly with geography. Additionally, some entities use advanced techniques such as planting beneficial species or applying growth retardants. Nonetheless, the events of August 14 and prior outages point to the need for independent verification that viable programs exist for ROW maintenance and that the programs are being followed.

Recommendation 4c: Each bulk electric transmission owner shall make its vegetation management procedure, and documentation of work completed, available for review and verification upon request by the applicable regional reliability council, NERC, or applicable federal, state or provincial regulatory agency.

Should this approach of monitoring vegetation-related line outages and procedures prove ineffective in reducing the number of vegetation-related line outages, NERC will consider the development of minimum line clearance standards to assure reliability.

Recommendation 5. Establish a Program to Track Implementation of Recommendations.

The August 14 blackout shared a number of contributing factors with prior large-scale blackouts, including:

- Conductors contacting trees
- Ineffective visualization of power system conditions and lack of situational awareness
- Ineffective communications
- Lack of training in recognizing and responding to emergencies
- Insufficient static and dynamic reactive power supply
- Need to improve relay protection schemes and coordination

³ All transmission lines operating at 230 kV and higher voltage, and any other lower voltage lines designated by the regional reliability council to be critical to the reliability of the bulk electric system, shall be included in the program.

⁴ A line trip includes a momentary opening and reclosing of the line, a lock out, or a combination. For reporting purposes, all vegetation-related openings of a line occurring within one 24-hour period should be considered one event. Trips known to be caused by severe weather or other natural disaster such as earthquake are excluded. Contact with vegetation includes both physical contact and arcing due to insufficient clearance.

Approved by the Board of Trustees
February 10, 2004

8

It is important that recommendations resulting from system outages be adopted consistently by all regions and operating entities, not just those directly affected by a particular outage. Several lessons learned prior to August 14, if heeded, could have prevented the outage. WECC and NPCC, for example, have programs that could be used as models for tracking completion of recommendations. NERC and some regions have not adequately tracked completion of recommendations from prior events to ensure they were consistently implemented.

Recommendation 5a: NERC and each regional reliability council shall establish a program for documenting completion of recommendations resulting from the August 14 blackout and other historical outages, as well as NERC and regional reports on violations of reliability standards, results of compliance audits, and lessons learned from system disturbances. Regions shall report quarterly to NERC on the status of follow-up actions to address recommendations, lessons learned, and areas noted for improvement. NERC staff shall report both NERC activities and a summary of regional activities to the board.

Assuring compliance with reliability standards, evaluating the reliability readiness of reliability coordinators and control areas, and assuring recommended actions are achieved will be effective steps in reducing the chances of future large-scale outages. However, it is important for NERC to also adopt a process for continuous learning and improvement by seeking continuous feedback on reliability performance trends, not rely mainly on learning from and reacting to catastrophic failures.

Recommendation 5b: NERC shall by January 1, 2005 establish a reliability performance monitoring function to evaluate and report bulk electric system reliability performance.

Such a function would assess large-scale outages and near misses to determine root causes and lessons learned, similar to the August 14 blackout investigation. This function would incorporate the current Disturbance Analysis Working Group and expand that work to provide more proactive feedback to the NERC board regarding reliability performance. This program would also gather and analyze reliability performance statistics to inform the board of reliability trends. This function could develop procedures and capabilities to initiate investigations in the event of future large-scale outages or disturbances. Such procedures and capabilities would be shared between NERC and the regional reliability councils for use as needed, with NERC and regional investigation roles clearly defined in advance.

Approved by the Board of Trustees
February 10, 2004

9

Technical Initiatives to Minimize the Likelihood and Impacts of Possible Future Cascading Outages

Recommendation 6. Improve Operator and Reliability Coordinator Training.

NERC found during its investigation that some reliability coordinators and control area operators had not received adequate training in recognizing and responding to system emergencies. Most notable was the lack of realistic simulations and drills for training and verifying the capabilities of operating personnel. This training deficiency contributed to the lack of situational awareness and failure to declare an emergency when operator intervention was still possible prior to the high speed portion of the sequence of events.

Recommendation 6: All reliability coordinators, control areas, and transmission operators shall provide at least five days per year of training and drills in system emergencies, using realistic simulations⁵, for each staff person with responsibility for the real-time operation or reliability monitoring of the bulk electric system. This system emergency training is in addition to other training requirements. Five days of system emergency training and drills are to be completed prior to June 30, 2004, with credit given for documented training already completed since July 1, 2003. Training documents, including curriculum, training methods, and individual training records, are to be available for verification during reliability readiness audits.

NERC has published Continuing Education Criteria specifying appropriate qualifications for continuing education providers and training activities.

In the longer term, the NERC Personnel Certification Governance Committee (PCGC), which is independent of the NERC board, should explore expanding the certification requirements of system operating personnel to include additional measures of competency in recognizing and responding to system emergencies. The current NERC certification examination is a written test of the NERC Operating Manual and other references relating to operator job duties, and is not by itself intended to be a complete demonstration of competency to handle system emergencies.

Recommendation 7. Evaluate Reactive Power and Voltage Control Practices.

The August 14 blackout investigation identified inconsistent practices in northeastern Ohio with regard to the setting and coordination of voltage limits and insufficient reactive power supply. Although the deficiency of reactive power supply in northeastern Ohio did not directly cause the blackout, it was a contributing factor and was a significant violation of existing reliability standards.

In particular, there appear to have been violations of NERC Planning Standard I.D.S1 requiring static and dynamic reactive power resources to meet the performance criteria specified in Table I of

⁵ The term “realistic simulations” includes a variety of tools and methods that present operating personnel with situations to improve and test diagnostic and decision-making skills in an environment that resembles expected conditions during a particular type of system emergency. Although a full replica training simulator is one approach, lower cost alternatives such as PC-based simulators, tabletop drills, and simulated communications can be effective training aids if used properly.

Planning Standard I.A on Transmission Systems. Planning Standard II.B.S1 requires each regional reliability council to establish procedures for generating equipment data verification and testing, including reactive power capability. Planning Standard III.C.S1 requires that all synchronous generators connected to the interconnected transmission systems shall be operated with their excitation system in the automatic voltage control mode unless approved otherwise by the transmission system operator. S2 of this standard also requires that generators shall maintain a network voltage or reactive power output as required by the transmission system operator within the reactive capability of the units.

On one hand, the unsafe conditions on August 14 with respect to voltage in northeastern Ohio can be said to have resulted from violations of NERC planning criteria for reactive power and voltage control, and those violations should have been identified through the NERC and ECAR compliance monitoring programs (addressed by Recommendation 2). On the other hand, investigators believe these deficiencies are also symptomatic of a systematic breakdown of the reliability studies and practices in FE and the ECAR region that allowed unsafe voltage criteria to be set and used in study models and operations. There were also issues identified with reactive characteristics of loads, as addressed in Recommendation 14.

Recommendation 7a: The Planning Committee shall reevaluate within one year the effectiveness of the existing reactive power and voltage control standards and how they are being implemented in practice in the ten NERC regions. Based on this evaluation, the Planning Committee shall recommend revisions to standards or process improvements to ensure voltage control and stability issues are adequately addressed.

Recommendation 7b: ECAR shall no later than June 30, 2004 review its reactive power and voltage criteria and procedures, verify that its criteria and procedures are being fully implemented in regional and member studies and operations, and report the results to the NERC board.

Recommendation 8. Improve System Protection to Slow or Limit the Spread of Future Cascading Outages.

The importance of automatic control and protection systems in preventing, slowing, or mitigating the impact of a large-scale outage cannot be stressed enough. To underscore this point, following the trip of the Sammis-Star line at 4:06, the cascading failure into parts of eight states and two provinces, including the trip of over 531 generating units and over 400 transmission lines, was completed in the next eight minutes. Most of the event sequence, in fact, occurred in the final 12 seconds of the cascade. Likewise, the July 2, 1996 failure took less than 30 seconds and the August 10, 1996 failure took only 5 minutes. It is not practical to expect operators will always be able to analyze a massive, complex system failure and to take the appropriate corrective actions in a matter of a few minutes. The NERC investigators believe that two measures would have been crucial in slowing or stopping the uncontrolled cascade on August 14:

- Better application of zone 3 impedance relays on high voltage transmission lines
- Selective use of under-voltage load shedding.

Approved by the Board of Trustees
February 10, 2004

11

First, beginning with the Sammis-Star line trip, most of the remaining line trips during the cascade phase were the result of the operation of a zone 3 relay for a perceived overload (a combination of high amperes and low voltage) on the protected line. If used, zone 3 relays typically act as an overreaching backup to the zone 1 and 2 relays, and are not intentionally set to operate on a line overload. However, under extreme conditions of low voltages and large power swings as seen on August 14, zone 3 relays can operate for overload conditions and propagate the outage to a wider area by essentially causing the system to “break up”. Many of the zone 3 relays that operated during the August 14 cascading outage were not set with adequate margins above their emergency thermal ratings. For the short times involved, thermal heating is not a problem and the lines should not be tripped for overloads. Instead, power system protection devices should be set to address the specific condition of concern, such as a fault, out-of-step condition, etc., and should not compromise a power system’s inherent physical capability to slow down or stop a cascading event.

Recommendation 8a: All transmission owners shall, no later than September 30, 2004, evaluate the zone 3 relay settings on all transmission lines operating at 230 kV and above for the purpose of verifying that each zone 3 relay is not set to trip on load under extreme emergency conditions⁶. In each case that a zone 3 relay is set so as to trip on load under extreme conditions, the transmission operator shall reset, upgrade, replace, or otherwise mitigate the overreach of those relays as soon as possible and on a priority basis, but no later than December 31, 2005. Upon completing analysis of its application of zone 3 relays, each transmission owner may no later than December 31, 2004 submit justification to NERC for applying zone 3 relays outside of these recommended parameters. The Planning Committee shall review such exceptions to ensure they do not increase the risk of widening a cascading failure of the power system.

A second key finding with regard to system protection was that if an automatic under-voltage load shedding scheme had been in place in the Cleveland-Akron area on August 14, there is a high probability the outage could have been limited to that area.

Recommendation 8b: Each regional reliability council shall complete an evaluation of the feasibility and benefits of installing under-voltage load shedding capability in load centers within the region that could become unstable as a result of being deficient in reactive power following credible multiple-contingency events. The regions are to complete the initial studies and report the results to NERC within one year. The regions are requested to promote the installation of under-voltage load shedding capabilities within critical areas, as determined by the studies to be effective in preventing an uncontrolled cascade of the power system.

The NERC investigation of the August 14 blackout has identified additional transmission and generation control and protection issues requiring further analysis. One concern is that generating unit control and protection schemes need to consider the full range of possible extreme system conditions, such as the low voltages and low and high frequencies experienced on August 14. The team also noted that improvements may be needed in under-frequency load shedding and its coordination with generator under- and over-frequency protection and controls.

⁶ The NERC investigation team recommends that the zone 3 relay, if used, should not operate at or below 150% of the emergency ampere rating of a line, assuming a .85 per unit voltage and a line phase angle of 30 degrees.

Recommendation 8c: The Planning Committee shall evaluate Planning Standard III – System Protection and Control and propose within one year specific revisions to the criteria to adequately address the issue of slowing or limiting the propagation of a cascading failure. The board directs the Planning Committee to evaluate the lessons from August 14 regarding relay protection design and application and offer additional recommendations for improvement.

Recommendation 9. Clarify Reliability Coordinator and Control Area Functions, Responsibilities, Capabilities and Authorities.

Ambiguities in the NERC operating policies may have allowed entities involved in the August 14 blackout to make different interpretations regarding the functions, responsibilities, capabilities, and authorities of reliability coordinators and control areas. Characteristics and capabilities necessary to enable prompt recognition and effective response to system emergencies must be specified.

The lack of timely and accurate outage information resulted in degraded performance of state estimator and reliability assessment functions on August 14. There is a need to review options for sharing of outage information in the operating time horizon (e.g. 15 minutes or less), so as to ensure the accurate and timely sharing of outage data necessary to support real-time operating tools such as state estimators, real-time contingency analysis, and other system monitoring tools.

On August 14, reliability coordinator and control area communications regarding conditions in northeastern Ohio were ineffective, and in some cases confusing. Ineffective communications contributed to a lack of situational awareness and precluded effective actions to prevent the cascade. Consistent application of effective communications protocols, particularly during emergencies, is essential to reliability. Alternatives should be considered to one-on-one phone calls during an emergency to ensure all parties are getting timely and accurate information with a minimum number of calls.

NERC operating policies do not adequately specify critical facilities, leaving ambiguity regarding which facilities must be monitored by reliability coordinators. Nor do the policies adequately define criteria for declaring transmission system emergencies. Operating policies should also clearly specify that curtailing interchange transactions through the NERC Transmission Loading Relief (TLR) Procedure is not intended as a method for restoring the system from an actual Operating Security Limit violation to a secure operating state.

Recommendation 9: The Operating Committee shall complete the following by June 30, 2004:

- **Evaluate and revise the operating policies and procedures, or provide interpretations, to ensure reliability coordinator and control area functions, responsibilities, and authorities are completely and unambiguously defined.**
- **Evaluate and improve the tools and procedures for operator and reliability coordinator communications during emergencies.**
- **Evaluate and improve the tools and procedures for the timely exchange of outage information among control areas and reliability coordinators.**

Approved by the Board of Trustees
February 10, 2004

13

Recommendation 10. Establish Guidelines for Real-Time Operating Tools.

The August 14 blackout was caused by a lack of situational awareness that was in turn the result of inadequate reliability tools and backup capabilities. Additionally, the failure of FE's control computers and alarm system contributed directly to the lack of situational awareness. Likewise, MISO's incomplete tool set and the failure of its state estimator to work effectively on August 14 contributed to the lack of situational awareness.

Recommendation 10: The Operating Committee shall within one year evaluate the real-time operating tools necessary for reliable operation and reliability coordination, including backup capabilities. The Operating Committee is directed to report both minimum acceptable capabilities for critical reliability functions and a guide of best practices.

This evaluation should include consideration of the following:

- Modeling requirements, such as model size and fidelity, real and reactive load modeling, sensitivity analyses, accuracy analyses, validation, measurement, observability, update procedures, and procedures for the timely exchange of modeling data.
- State estimation requirements, such as periodicity of execution, monitoring external facilities, solution quality, topology error and measurement error detection, failure rates including times between failures, presentation of solution results including alarms, and troubleshooting procedures.
- Real-time contingency analysis requirements, such as contingency definition, periodicity of execution, monitoring external facilities, solution quality, post-contingency automatic actions, failure rates including mean/maximum times between failures, reporting of results, presentation of solution results including alarms, and troubleshooting procedures including procedures for investigating unsolvable contingencies.

Recommendation 11. Evaluate Lessons Learned During System Restoration.

The efforts to restore the power system and customer service following the outage were effective, considering the massive amount of load lost and the large number of generators and transmission lines that tripped. Fortunately, the restoration was aided by the ability to energize transmission from neighboring systems, thereby speeding the recovery. Despite the apparent success of the restoration effort, it is important to evaluate the results in more detail to determine opportunities for improvement. Blackstart and restoration plans are often developed through study of simulated conditions. Robust testing of live systems is difficult because of the risk of disturbing the system or interrupting customers. The August 14 blackout provides a valuable opportunity to apply actual events and experiences to learn to better prepare for system blackstart and restoration in the future. That opportunity should not be lost, despite the relative success of the restoration phase of the outage.

Recommendation 11a: The Planning Committee, working in conjunction with the Operating Committee, NPCC, ECAR, and PJM, shall evaluate the black start and system restoration performance following the outage of August 14, and within one year report to the NERC board the results of that evaluation with recommendations for improvement.

Approved by the Board of Trustees
February 10, 2004

14

Recommendation 11b: All regional reliability councils shall, within six months of the Planning Committee report to the NERC board, reevaluate their procedures and plans to assure an effective blackstart and restoration capability within their region.

Recommendation 12. Install Additional Time-Synchronized Recording Devices as Needed.

A valuable lesson from the August 14 blackout is the importance of having time-synchronized system data recorders. NERC investigators labored over thousands of data items to synchronize the sequence of events, much like putting together small pieces of a very large puzzle. That process would have been significantly improved and sped up if there had been a sufficient number of synchronized data recording devices.

NERC Planning Standard I.F – Disturbance Monitoring does require location of recording devices for disturbance analysis. Often time, recorders are available, but they are not synchronized to a time standard. All digital fault recorders, digital event recorders, and power system disturbance recorders should be time stamped at the point of observation with a precise Global Positioning Satellite (GPS) synchronizing signal. Recording and time-synchronization equipment should be monitored and calibrated to assure accuracy and reliability.

Time-synchronized devices, such as phasor measurement units, can also be beneficial for monitoring a wide-area view of power system conditions in real-time, such as demonstrated in WECC with their Wide-Area Monitoring System (WAMS).

Recommendation 12a: The reliability regions, coordinated through the NERC Planning Committee, shall within one year define regional criteria for the application of synchronized recording devices in power plants and substations. Regions are requested to facilitate the installation of an appropriate number, type and location of devices within the region as soon as practical to allow accurate recording of future system disturbances and to facilitate benchmarking of simulation studies by comparison to actual disturbances.

Recommendation 12b: Facilities owners shall, in accordance with regional criteria, upgrade existing dynamic recorders to include GPS time synchronization and, as necessary, install additional dynamic recorders.

Recommendation 13. Reevaluate System Design, Planning and Operating Criteria.

The investigation report noted that FE entered the day on August 14 with insufficient resources to stay within operating limits following a credible set of contingencies, such as the loss of the East Lake 5 unit and the Chamberlin-Harding line. NERC will conduct an evaluation of operations planning practices and criteria to ensure expected practices are sufficient and well understood. The review will reexamine fundamental operating criteria, such as n-1 and the 30-minute limit in preparing the system for a next contingency, and Table I Category C.3 of the NERC planning standards. Operations planning and operating criteria will be identified that are sufficient to ensure the system is in a known and reliable condition at all times, and that positive controls, whether

Approved by the Board of Trustees
February 10, 2004

15

manual or automatic, are available and appropriately located at all times to return the Interconnection to a secure condition. Daily operations planning, and subsequent real time operations planning will identify available system reserves to meet operating criteria.

Recommendation 13a: The Operating Committee shall evaluate operations planning and operating criteria and recommend revisions in a report to the board within one year.

Prior studies in the ECAR region did not adequately define the system conditions that were observed on August 14. Severe contingency criteria were not adequate to address the events of August 14 that led to the uncontrolled cascade. Also, northeastern Ohio was found to have insufficient reactive support to serve its loads and meet import criteria. Instances were also noted in the FE system and ECAR area of different ratings being used for the same facility by planners and operators and among entities, making the models used for system planning and operation suspect. NERC and the regional reliability councils must take steps to assure facility ratings are being determined using consistent criteria and being effectively shared and reviewed among entities and among planners and operators.

Recommendation 13b: ECAR shall no later than June 30, 2004 reevaluate its planning and study procedures and practices to ensure they are in compliance with NERC standards, ECAR Document No. 1, and other relevant criteria; and that ECAR and its members' studies are being implemented as required.

Recommendation 13c: The Planning Committee, working in conjunction with the regional reliability councils, shall within two years reevaluate the criteria, methods and practices used for system design, planning and analysis; and shall report the results and recommendations to the NERC board. This review shall include an evaluation of transmission facility ratings methods and practices, and the sharing of consistent ratings information.

Regional reliability councils may consider assembling a regional database that includes the ratings of all bulk electric system (100 kV and higher voltage) transmission lines, transformers, phase angle regulators, and phase shifters. This database should be shared with neighboring regions as needed for system planning and analysis.

NERC and the regional reliability councils should review the scope, frequency, and coordination of interregional studies, to include the possible need for simultaneous transfer studies. Study criteria will be reviewed, particularly the maximum credible contingency criteria used for system analysis. Each control area will be required to identify, for both the planning and operating time horizons, the planned emergency import capabilities for each major load area.

Recommendation 14. Improve System Modeling Data and Data Exchange Practices.

The after-the-fact models developed to simulate August 14 conditions and events indicate that dynamic modeling assumptions, including generator and load power factors, used in planning and operating models were inaccurate. Of particular note, the assumptions of load power factor were overly optimistic (loads were absorbing much more reactive power than pre-August 14 models indicated). Another suspected problem is modeling of shunt capacitors under depressed voltage

Approved by the Board of Trustees
February 10, 2004

16

conditions. Regional reliability councils should establish regional power system models that enable the sharing of consistent, validated data among entities in the region. Power flow and transient stability simulations should be periodically compared (benchmarked) with actual system events to validate model data. Viable load (including load power factor) and generator testing programs are necessary to improve agreement between power flows and dynamic simulations and the actual system performance.

Recommendation 14: The regional reliability councils shall within one year establish and begin implementing criteria and procedures for validating data used in power flow models and dynamic simulations by benchmarking model data with actual system performance. Validated modeling data shall be exchanged on an inter-regional basis as needed for reliable system planning and operation.

During the data collection phase of the blackout investigation, when control areas were asked for information pertaining to merchant generation within their area, data was frequently not supplied. The reason often given was that the control area did not know the status or output of the generator at a given point in time. Another reason was the commercial sensitivity or confidentiality of such data.

Approved by the Board of Trustees
February 10, 2004

17

Appendix E

List of Electricity Acronyms

AEP	American Electric Power
BPA	Bonneville Power Administration
CA	Control area
CNSC	Canadian Nuclear Safety Commission
DOE	Department of Energy (U.S.)
ECAR	East Central Area Reliability Coordination Agreement
EIA	Energy Information Administration (U.S. DOE)
EMS	Energy management system
ERCOT	Electric Reliability Council of Texas
ERO	Electric reliability organization
FE	FirstEnergy
FERC	Federal Energy Regulatory Commission (U.S.)
FRCC	Florida Reliability Coordinating Council
GW, GWh	Gigawatt, Gigawatt-hour
IEEE	Institute of Electrical and Electronics Engineers
IPP	Independent power producer
ISAC	Information Sharing and Analysis Center
kV, kVAr	Kilovolt, Kilovolt-Amperes-reactive
kW, kWh	Kilowatt, Kilowatt-hour
MAAC	Mid-Atlantic Area Council
MAIN	Mid-America Interconnected Network
MAPP	Mid-Continent Area Power Pool
MECS	Michigan Electrical Coordinated Systems
MVA, MVAr	Megavolt-Amperes, Megavolt-Amperes-reactive
MW, MWh	Megawatt, Megawatt-hour
NERC	North American Electric Reliability Council
NESC	National Electricity Safety Code
NPCC	Northeast Power Coordinating Council
NRC	Nuclear Regulatory Commission (U.S.)
NRCan	Natural Resources Canada
OASIS	Open Access Same Time Information Service
OETD	Office of Electric Transmission and Distribution (U.S. DOE)
PJM	PJM Interconnection
PUC	Public utility (or public service) commission (state)
RC	Reliability coordinator
ROW	Right-of-Way (transmission or distribution line, pipeline, etc.)
RRC	Regional reliability council
RTO	Regional Transmission Organization
SCADA	Supervisory control and data acquisition
SERC	Southeast Electric Reliability Council
SPP	Southwest Power Pool
TVA	Tennessee Valley Authority (U.S.)
WECC	Western Electricity Coordinating Council

Appendix F

Electricity Glossary

AC: Alternating current; current that changes periodically (sinusoidally) with time.

ACE: Area Control Error in MW. A negative value indicates a condition of under-generation relative to system load and imports, and a positive value denotes over-generation.

Active Power: See “Real Power.”

Adequacy: The ability of the electric system to supply the aggregate electrical demand and energy requirements of customers at all times, taking into account scheduled and reasonably expected unscheduled outages of system elements.

AGC: Automatic Generation Control is a computation based on measured frequency and computed economic dispatch. Generation equipment under AGC automatically responds to signals from an EMS computer in real time to adjust power output in response to a change in system frequency, tie-line loading, or to a prescribed relation between these quantities. Generator output is adjusted so as to maintain a target system frequency (usually 60 Hz) and any scheduled MW interchange with other areas.

Apparent Power: The product of voltage and current phasors. It comprises both active and reactive power, usually expressed in kilovoltamperes (kVA) or megavoltamperes (MVA).

Blackstart Capability: The ability of a generating unit or station to go from a shutdown condition to an operating condition and start delivering power without assistance from the bulk electric system.

Bulk Electric System: A term commonly applied to the portion of an electric utility system that encompasses the electrical generation resources and bulk transmission system.

Bulk Transmission: A functional or voltage classification relating to the higher voltage portion of the transmission system, specifically, lines at or above a voltage level of 115 kV.

Bus: Shortened from the word busbar, meaning a node in an electrical network where one or more elements are connected together.

Capacitor Bank: A capacitor is an electrical device that provides reactive power to the system and is

often used to compensate for reactive load and help support system voltage. A bank is a collection of one or more capacitors at a single location.

Capacity: The rated continuous load-carrying ability, expressed in megawatts (MW) or megavolt-amperes (MVA) of generation, transmission, or other electrical equipment.

Cascading: The uncontrolled successive loss of system elements triggered by an incident. Cascading results in widespread service interruption, which cannot be restrained from sequentially spreading beyond an area predetermined by appropriate studies.

Circuit: A conductor or a system of conductors through which electric current flows.

Circuit Breaker: A switching device connected to the end of a transmission line capable of opening or closing the circuit in response to a command, usually from a relay.

Control Area: An electric power system or combination of electric power systems to which a common automatic control scheme is applied in order to: (1) match, at all times, the power output of the generators within the electric power system(s) and capacity and energy purchased from entities outside the electric power system(s), with the load in the electric power system(s); (2) maintain, within the limits of Good Utility Practice, scheduled interchange with other Control Areas; (3) maintain the frequency of the electric power system(s) within reasonable limits in accordance with Good Utility Practice; and (4) provide sufficient generating capacity to maintain operating reserves in accordance with Good Utility Practice.

Contingency: The unexpected failure or outage of a system component, such as a generator, transmission line, circuit breaker, switch, or other electrical element. A contingency also may include multiple components, which are related by situations leading to simultaneous component outages.

Control Area Operator: An individual or organization responsible for controlling generation to maintain interchange schedule with other control areas and contributing to the frequency regulation of the interconnection. The control area is an

electric system that is bounded by interconnection metering and telemetry.

Current (Electric): The rate of flow of electrons in an electrical conductor measured in Amperes.

Curtailed: The right of a transmission provider to interrupt all or part of a transmission service due to constraints that reduce the capability of the transmission network to provide that transmission service. Transmission service is to be curtailed only in cases where system reliability is threatened or emergency conditions exist.

Demand: The rate at which electric energy is delivered to consumers or by a system or part of a system, generally expressed in kilowatts or megawatts, at a given instant or averaged over any designated interval of time. Also see “Load.”

DC: Direct current; current that is steady and does not change sinusoidally with time (see “AC”).

Dispatch Operator: Control of an integrated electric system involving operations such as assignment of levels of output to specific generating stations and other sources of supply; control of transmission lines, substations, and equipment; operation of principal interties and switching; and scheduling of energy transactions.

Distribution: For electricity, the function of distributing electric power using low voltage lines to retail customers.

Distribution Network: The portion of an electric system that is dedicated to delivering electric energy to an end user, at or below 69 kV. The distribution network consists primarily of low-voltage lines and transformers that “transport” electricity from the bulk power system to retail customers.

Disturbance: An unplanned event that produces an abnormal system condition.

Electrical Energy: The generation or use of electric power by a device over a period of time, expressed in kilowatthours (kWh), megawatthours (MWh), or gigawatthours (GWh).

Electric Utility: Person, agency, authority, or other legal entity or instrumentality that owns or operates facilities for the generation, transmission, distribution, or sale of electric energy primarily for use by the public, and is defined as a utility under the statutes and rules by which it is regulated. An electric utility can be investor-owned, cooperatively owned, or government-

owned (by a federal agency, crown corporation, State, provincial government, municipal government, and public power district).

Element: Any electric device with terminals that may be connected to other electric devices, such as a generator, transformer, circuit, circuit breaker, or bus section.

Energy Emergency: A condition when a system or power pool does not have adequate energy resources (including water for hydro units) to supply its customers’ expected energy requirements.

Emergency: Any abnormal system condition that requires automatic or immediate manual action to prevent or limit loss of transmission facilities or generation supply that could adversely affect the reliability of the electric system.

Emergency Voltage Limits: The operating voltage range on the interconnected systems that is acceptable for the time, sufficient for system adjustments to be made following a facility outage or system disturbance.

EMS: An energy management system is a computer control system used by electric utility dispatchers to monitor the real time performance of various elements of an electric system and to control generation and transmission facilities.

Fault: A fault usually means a short circuit, but more generally it refers to some abnormal system condition. Faults are often random events.

Federal Energy Regulatory Commission (FERC): Independent Federal agency that, among other responsibilities, regulates the transmission and wholesale sales of electricity in interstate commerce.

Flashover: A plasma arc initiated by some event such as lightning. Its effect is a short circuit on the network.

Flowgate: A single or group of transmission elements intended to model MW flow impact relating to transmission limitations and transmission service usage.

Forced Outage: The removal from service availability of a generating unit, transmission line, or other facility for emergency reasons or a condition in which the equipment is unavailable due to unanticipated failure.

Frequency: The number of complete alternations or cycles per second of an alternating current, measured in Hertz. The standard frequency in the

United States is 60 Hz. In some other countries the standard is 50 Hz.

Frequency Deviation or Error: A departure from scheduled frequency; the difference between actual system frequency and the scheduled system frequency.

Frequency Regulation: The ability of a Control Area to assist the interconnected system in maintaining scheduled frequency. This assistance can include both turbine governor response and automatic generation control.

Frequency Swings: Constant changes in frequency from its nominal or steady-state value.

Generation (Electricity): The process of producing electrical energy from other forms of energy; also, the amount of electric energy produced, usually expressed in kilowatt hours (kWh) or megawatt hours (MWh).

Generator: Generally, an electromechanical device used to convert mechanical power to electrical power.

Grid: An electrical transmission and/or distribution network.

Grid Protection Scheme: Protection equipment for an electric power system, consisting of circuit breakers, certain equipment for measuring electrical quantities (e.g., current and voltage sensors) and devices called relays. Each relay is designed to protect the piece of equipment it has been assigned from damage. The basic philosophy in protection system design is that any equipment that is threatened with damage by a sustained fault is to be automatically taken out of service.

Ground: A conducting connection between an electrical circuit or device and the earth. A ground may be intentional, as in the case of a safety ground, or accidental, which may result in high overcurrents.

Imbalance: A condition where the generation and interchange schedules do not match demand.

Impedance: The total effects of a circuit that oppose the flow of an alternating current consisting of inductance, capacitance, and resistance. It can be quantified in the units of ohms.

Independent System Operator (ISO): An organization responsible for the reliable operation of the power grid under its purview and for providing open transmission access to all market participants on a nondiscriminatory basis. An ISO is

usually not-for-profit and can advise utilities within its territory on transmission expansion and maintenance but does not have the responsibility to carry out the functions.

Interchange: Electric power or energy that flows across tie-lines from one entity to another, whether scheduled or inadvertent.

Interconnected System: A system consisting of two or more individual electric systems that normally operate in synchronism and have connecting tie lines.

Interconnection: When capitalized, any one of the five major electric system networks in North America: Eastern, Western, ERCOT (Texas), Québec, and Alaska. When not capitalized, the facilities that connect two systems or Control Areas. Additionally, an interconnection refers to the facilities that connect a nonutility generator to a Control Area or system.

Interface: The specific set of transmission elements between two areas or between two areas comprising one or more electrical systems.

ISAC: Information Sharing and Analysis Centers (ISACs) are designed by the private sector and serve as a mechanism for gathering, analyzing, appropriately sanitizing and disseminating private sector information. These centers could also gather, analyze, and disseminate information from Government for further distribution to the private sector. ISACs also are expected to share important information about vulnerabilities, threats, intrusions, and anomalies, but do not interfere with direct information exchanges between companies and the Government.

Island: A portion of a power system or several power systems that is electrically separated from the interconnection due to the disconnection of transmission system elements.

Kilovar (kVAR): Unit of alternating current reactive power equal to 1,000 VARs.

Kilovolt (kV): Unit of electrical potential equal to 1,000 Volts.

Kilovolt-Amperes (kVA): Unit of apparent power equal to 1,000 volt amperes. Here, apparent power is in contrast to real power. On AC systems the voltage and current will not be in phase if reactive power is being transmitted.

Kilowatthour (kWh): Unit of energy equaling one thousand watthours, or one kilowatt used over one hour. This is the normal quantity used for

metering and billing electricity customers. The retail price for a kWh varies from approximately 4 cents to 15 cents. At a 100% conversion efficiency, one kWh is equivalent to about 4 fluid ounces of gasoline, 3/16 pound of liquid petroleum, 3 cubic feet of natural gas, or 1/4 pound of coal.

Line Trip: Refers to the automatic opening of the conducting path provided by a transmission line by the circuit breakers. These openings or “trips” are to protect the transmission line during faulted conditions.

Load (Electric): The amount of electric power delivered or required at any specific point or points on a system. The requirement originates at the energy-consuming equipment of the consumers. See “Demand.”

Load Shedding: The process of deliberately removing (either manually or automatically) pre-selected customer demand from a power system in response to an abnormal condition, to maintain the integrity of the system and minimize overall customer outages.

Lockout: A state of a transmission line following breaker operations where the condition detected by the protective relaying was not eliminated by temporarily opening and reclosing the line, possibly several times. In this state, the circuit breakers cannot generally be reclosed without resetting a lockout device.

Market Participant: An entity participating in the energy marketplace by buying/selling transmission rights, energy, or ancillary services into, out of, or through an ISO-controlled grid.

Megawatthour (MWh): One million watthours.

Metered Value: A measured electrical quantity that may be observed through telemetering, supervisory control and data acquisition (SCADA), or other means.

Metering: The methods of applying devices that measure and register the amount and direction of electrical quantities with respect to time.

NERC Interregional Security Network (ISN): A communications network used to exchange electric system operating parameters in near real time among those responsible for reliable operations of the electric system. The ISN provides timely and accurate data and information exchange among reliability coordinators and other system operators. The ISN, which operates over the frame relay NERCnet system, is a private Intranet that is

capable of handling additional applications between participants.

Normal (Precontingency) Operating Procedures: Operating procedures that are normally invoked by the system operator to alleviate potential facility overloads or other potential system problems in anticipation of a contingency.

Normal Voltage Limits: The operating voltage range on the interconnected systems that is acceptable on a sustained basis.

North American Electric Reliability Council (NERC): A not-for-profit company formed by the electric utility industry in 1968 to promote the reliability of the electricity supply in North America. NERC consists of nine Regional Reliability Councils and one Affiliate, whose members account for virtually all the electricity supplied in the United States, Canada, and a portion of Baja California Norte, Mexico. The members of these Councils are from all segments of the electricity supply industry: investor-owned, federal, rural electric cooperative, state/municipal, and provincial utilities, independent power producers, and power marketers. The NERC Regions are: East Central Area Reliability Coordination Agreement (ECAR); Electric Reliability Council of Texas (ERCOT); Mid-Atlantic Area Council (MAAC); Mid-America Interconnected Network (MAIN); Mid-Continent Area Power Pool (MAPP); Northeast Power Coordinating Council (NPCC); Southeastern Electric Reliability Council (SERC); Southwest Power Pool (SPP); Western Systems Coordinating Council (WSCC); and Alaskan Systems Coordination Council (ASCC, Affiliate).

OASIS: Open Access Same Time Information Service (OASIS), developed by the Electric Power Research Institute, is designed to facilitate open access by providing users with access to information on transmission services and availability, plus facilities for transactions.

Operating Criteria: The fundamental principles of reliable interconnected systems operation, adopted by NERC.

Operating Guides: Operating practices that a Control Area or systems functioning as part of a Control Area may wish to consider. The application of Guides is optional and may vary among Control Areas to accommodate local conditions and individual system requirements.

Operating Policies: The doctrine developed for interconnected systems operation. This doctrine

consists of Criteria, Standards, Requirements, Guides, and instructions, which apply to all Control Areas.

Operating Procedures: A set of policies, practices, or system adjustments that may be automatically or manually implemented by the system operator within a specified time frame to maintain the operational integrity of the interconnected electric systems.

Operating Requirements: Obligations of a Control Area and systems functioning as part of a Control Area.

Operating Security Limit: The value of a system operating parameter (e.g. total power transfer across an interface) that satisfies the most limiting of prescribed pre- and post-contingency operating criteria as determined by equipment loading capability and acceptable stability and voltage conditions. It is the operating limit to be observed so that the transmission system will remain reliable even if the worst contingency occurs.

Operating Standards: The obligations of a Control Area and systems functioning as part of a Control Area that are measurable. An Operating Standard may specify monitoring and surveys for compliance.

Outage: The period during which a generating unit, transmission line, or other facility is out of service.

Planning Guides: Good planning practices and considerations that Regions, subregions, power pools, or individual systems should follow. The application of Planning Guides may vary to match local conditions and individual system requirements.

Planning Policies: The framework for the reliability of interconnected bulk electric supply in terms of responsibilities for the development of and conformance to NERC Planning Principles and Guides and Regional planning criteria or guides, and NERC and Regional issues resolution processes. NERC Planning Procedures, Principles, and Guides emanate from the Planning Policies.

Planning Principles: The fundamental characteristics of reliable interconnected bulk electric systems and the tenets for planning them.

Planning Procedures: An explanation of how the Planning Policies are addressed and implemented by the NERC Engineering Committee, its

subgroups, and the Regional Councils to achieve bulk electric system reliability.

Post-contingency Operating Procedures: Operating procedures that may be invoked by the system operator to mitigate or alleviate system problems after a contingency has occurred.

Protective Relay: A device designed to detect abnormal system conditions, such as electrical shorts on the electric system or within generating plants, and initiate the operation of circuit breakers or other control equipment.

Power/Phase Angle: The angular relationship between an AC (sinusoidal) voltage across a circuit element and the AC (sinusoidal) current through it. The real power that can flow is related to this angle.

Power: See “Real Power.”

Power Flow: See “Current.”

Rate: The authorized charges per unite or level of consumption for a specified time period for any of the classes of utility services provided to a customer.

Rating: The operational limits of an electric system, facility, or element under a set of specified conditions.

Reactive Power: The portion of electricity that establishes and sustains the electric and magnetic fields of alternating-current equipment. Reactive power must be supplied to most types of magnetic equipment, such as motors and transformers. It also must supply the reactive losses on transmission facilities. Reactive power is provided by generators, synchronous condensers, or electrostatic equipment such as capacitors and directly influences electric system voltage. It is usually expressed in kilovars (kVAr) or megavars (MVar), and is the mathematical product of voltage and current consumed by reactive loads. Examples of reactive loads include capacitors and inductors. These types of loads, when connected to an ac voltage source, will draw current, but because the current is 90 degrees out of phase with the applied voltage, they actually consume no real power.

Readiness: The extent to which an organizational entity is prepared to meet the functional requirements set by NERC or its regional council for entities of that type or class.

Real Power: Also known as “active power.” The rate at which work is performed or that energy is

transferred, usually expressed in kilowatts (kW) or megawatts (MW). The terms “active power” or “real power” are often used in place of the term power alone to differentiate it from reactive power.

Real-Time Operations: The instantaneous operations of a power system as opposed to those operations that are simulated.

Regional Reliability Council: One of ten Electric Reliability Councils that form the North American Electric Reliability Council (NERC).

Regional Transmission Operator (RTO): An organization that is independent from all generation and power marketing interests and has exclusive responsibility for electric transmission grid operations, short-term electric reliability, and transmission services within a multi-State region. To achieve those objectives, the RTO manages transmission facilities owned by different companies and encompassing one, large, contiguous geographic area.

Regulations: Rules issued by regulatory authorities to implement laws passed by legislative bodies.

Relay: A device that controls the opening and subsequent reclosing of circuit breakers. Relays take measurements from local current and voltage transformers, and from communication channels connected to the remote end of the lines. A relay output trip signal is sent to circuit breakers when needed.

Relay Setting: The parameters that determine when a protective relay will initiate operation of circuit breakers or other control equipment.

Reliability: The degree of performance of the elements of the bulk electric system that results in electricity being delivered to customers within accepted standards and in the amount desired. Reliability may be measured by the frequency, duration, and magnitude of adverse effects on the electric supply. Electric system reliability can be addressed by considering two basic and functional aspects of the electric system, Adequacy and Security.

Reliability Coordinator: An individual or organization responsible for the safe and reliable operation of the interconnected transmission system for their defined area, in accordance with NERC reliability standards, regional criteria, and subregional criteria and practices. This entity facilitates the sharing of data and information about the status of the Control Areas for which it is responsible,

establishes a security policy for these Control Areas and their interconnections, and coordinates emergency operating procedures that rely on common operating terminology, criteria, and standards.

Resistance: The characteristic of materials to restrict the flow of current in an electric circuit. Resistance is inherent in any electric wire, including those used for the transmission of electric power. Resistance in the wire is responsible for heating the wire as current flows through it and the subsequent power loss due to that heating.

Restoration: The process of returning generators and transmission system elements and restoring load following an outage on the electric system.

Right-of-Way (ROW) Maintenance: Activities by utilities to maintain electrical clearances along transmission or distribution lines.

Safe Limits: System limits on quantities such as voltage or power flows such that if the system is operated within these limits it is secure and reliable.

SCADA: Supervisory Control and Data Acquisition system; a system of remote control and telemetry used to monitor and control the electric system.

Schedule: An agreed-upon transaction size (megawatts), start and end time, beginning and ending ramp times and rate, and type required for delivery and receipt of power and energy between the contracting parties and the Control Area(s) involved in the transaction.

Scheduling Coordinator: An entity certified by an ISO or RTO for the purpose of undertaking scheduling functions.

Seams: The boundaries between adjacent electricity-related organizations. Differences in regulatory requirements or operating practices may create “seams problems.”

Security: The ability of the electric system to withstand sudden disturbances such as electric short circuits or unanticipated loss of system elements.

Security Coordinator: An individual or organization that provides the security assessment and emergency operations coordination for a group of Control Areas.

Short Circuit: A low resistance connection unintentionally made between points of an electrical circuit, which may result in current flow far above normal levels.

Shunt Capacitor Bank: Shunt capacitors are capacitors connected from the power system to an electrical ground. They are used to supply kilovars (reactive power) to the system at the point where they are connected. A shunt capacitor bank is a group of shunt capacitors.

Single Contingency: The sudden, unexpected failure or outage of a system facility(s) or element(s) (generating unit, transmission line, transformer, etc.). Elements removed from service as part of the operation of a remedial action scheme are considered part of a single contingency.

Special Protection System: An automatic protection system designed to detect abnormal or predetermined system conditions, and take corrective actions other than and/or in addition to the isolation of faulted components.

Stability: The ability of an electric system to maintain a state of equilibrium during normal and abnormal system conditions or disturbances.

Stability Limit: The maximum power flow possible through a particular point in the system while maintaining stability in the entire system or the part of the system to which the stability limit refers.

State Estimator: Computer software that takes redundant measurements of quantities related to system state as input and provides an estimate of the system state (bus voltage phasors). It is used to confirm that the monitored electric power system is operating in a secure state by simulating the system both at the present time and one step ahead, for a particular network topology and loading condition. With the use of a state estimator and its associated contingency analysis software, system operators can review each critical contingency to determine whether each possible future state is within reliability limits.

Station: A node in an electrical network where one or more elements are connected. Examples include generating stations and substations.

Storage: Energy transferred from one entity to another entity that has the ability to conserve the energy (i.e., stored as water in a reservoir, coal in a pile, etc.) with the intent that the energy will be returned at a time when such energy is more useable to the original supplying entity.

Substation: Facility equipment that switches, changes, or regulates electric voltage.

Subtransmission: A functional or voltage classification relating to lines at voltage levels between 69kV and 115kV.

Supervisory Control and Data Acquisition (SCADA): See SCADA.

Surge: A transient variation of current, voltage, or power flow in an electric circuit or across an electric system.

Surge Impedance Loading: The maximum amount of real power that can flow down a lossless transmission line such that the line does not require any VARs to support the flow.

Switching Station: Facility equipment used to tie together two or more electric circuits through switches. The switches are selectively arranged to permit a circuit to be disconnected, or to change the electric connection between the circuits.

Synchronize: The process of connecting two previously separated alternating current apparatuses after matching frequency, voltage, phase angles, etc. (e.g., paralleling a generator to the electric system).

System: An interconnected combination of generation, transmission, and distribution components comprising an electric utility and independent power producer(s) (IPP), or group of utilities and IPP(s).

System Operator: An individual at an electric system control center whose responsibility it is to monitor and control that electric system in real time.

System Reliability: A measure of an electric system's ability to deliver uninterrupted service at the proper voltage and frequency.

Thermal Limit: A power flow limit based on the possibility of damage by heat. Heating is caused by the electrical losses which are proportional to the square of the *real power* flow. More precisely, a thermal limit restricts the sum of the squares of *real* and *reactive power*.

Tie-line: The physical connection (e.g. transmission lines, transformers, switch gear, etc.) between two electric systems that permits the transfer of electric energy in one or both directions.

Time Error: An accumulated time difference between Control Area system time and the time standard. Time error is caused by a deviation in Interconnection frequency from 60.0 Hertz.

Time Error Correction: An offset to the Interconnection's scheduled frequency to correct for the time error accumulated on electric clocks.

Transactions: Sales of bulk power via the transmission grid.

Transfer Limit: The maximum amount of power that can be transferred in a reliable manner from one area to another over all transmission lines (or paths) between those areas under specified system conditions.

Transformer: A device that operates on magnetic principles to increase (step up) or decrease (step down) voltage.

Transient Stability: The ability of an electric system to maintain synchronism between its parts when subjected to a disturbance and to regain a state of equilibrium following that disturbance.

Transmission: An interconnected group of lines and associated equipment for the movement or transfer of electric energy between points of supply and points at which it is transformed for delivery to customers or is delivered to other electric systems.

Transmission Loading Relief (TLR): A procedure used to manage congestion on the electric transmission system.

Transmission Margin: The difference between the maximum power flow a transmission line can handle and the amount that is currently flowing on the line.

Transmission Operator: NERC-certified party responsible for monitoring and assessing local reliability conditions, who operates the transmission facilities, and who executes switching orders in support of the Reliability Authority.

Transmission Overload: A state where a transmission line has exceeded either a normal or emergency rating of the electric conductor.

Transmission Owner (TO) or Transmission Provider: Any utility that owns, operates, or controls

facilities used for the transmission of electric energy.

Trip: The opening of a circuit breaker or breakers on an electric system, normally to electrically isolate a particular element of the system to prevent it from being damaged by fault current or other potentially damaging conditions. See “Line Trip” for example.

Voltage: The electrical force, or “pressure,” that causes current to flow in a circuit, measured in Volts.

Voltage Collapse (decay): An event that occurs when an electric system does not have adequate reactive support to maintain voltage stability. Voltage Collapse may result in outage of system elements and may include interruption in service to customers.

Voltage Control: The control of transmission voltage through adjustments in generator reactive output and transformer taps, and by switching capacitors and inductors on the transmission and distribution systems.

Voltage Limits: A hard limit above or below which is an undesirable operating condition. Normal limits are between 95 and 105 percent of the nominal voltage at the bus under discussion.

Voltage Reduction: A procedure designed to deliberately lower the voltage at a bus. It is often used as a means to reduce demand by lowering the customer’s voltage.

Voltage Stability: The condition of an electric system in which the sustained voltage level is controllable and within predetermined limits.

Watt-hour (Wh): A unit of measure of electrical energy equal to 1 watt of power supplied to, or taken from, an electric circuit steadily for 1 hour.

Appendix G

Transmittal Letters from the Three Working Groups

Mr. James W. Glotfelty
Director, Office of Electric Transmission
and Distribution
U.S. Department of Energy
1000 Independence Avenue SW
Washington, DC 20585

Dr. Nawal Kamel
Special Assistant to the Deputy Minister
Natural Resources Canada
580 Booth Street
Ottawa, ON
K1A 0E4

Dear Mr. Glotfelty and Dr. Kamel:

Enclosed is the Final Report of the Electric System Working Group (ESWG) supporting the United States - Canada Power System Outage Task Force.

This report presents the results of an intensive and thorough investigation by a bi-national team into the causes of the blackout that occurred on August 14, 2003, and recommendations to prevent and reduce the scope of future blackouts. We believe that systematic implementation of these recommendations is critical to maintaining the reliability of bulk power supplies in North America.

The report was written largely by the three co-chairs of the Electric System Working Group (David Meyer, Alison Silverstein, and Tom Rusnov), who also co-chaired the Task Force's Electric System Investigation. They did so with the benefit of extensive input and assistance from many members of the investigation team. Other members of the ESWG reviewed the report in draft and provided valuable suggestions for its improvement. Those members join us in this submittal and have signed on the following page.

Sincerely,



David H. Meyer
Senior Advisor
U.S. Department
of Energy
Co-Chair, Electric
System Working Group



Thomas Rusnov
Senior Advisor
Natural Resources
Canada
Co-Chair, Electric
System Working Group



Alison Silverstein
Senior Energy Policy Advisor
to the Chairman
Federal Energy Regulatory
Commission
Co-Chair, Electric
System Working Group



David Barrie
Senior Vice President
Asset Management
Hydro One Inc.

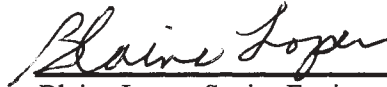

Blaine Loper, Senior Engineer
Pennsylvania Public Utility Commission

2



David Burpee, Director,
Renewable and Electrical Energy Division
Natural Resources Canada



David McFadden
Chair, National Energy and Infrastructure
Industry Group
Gowlings, Lafleur, Henderson LLP
Ontario



For Donald W. Downes

Donald Downes, Chairman
Connecticut Department of
Public Utility Control



David O'Brien, Commissioner
Vermont Department of Public Service



Joseph Eto, Staff Scientist
Lawrence Berkeley National Laboratory
(U.S.), and Consortium for Electric
Reliability Solutions



David O'Connor, Commissioner
Div. of Energy Resources
Massachusetts Office of Consumer Affairs
And Business Regulation



Jeanne Fox, President
New Jersey Board of Public Utilities

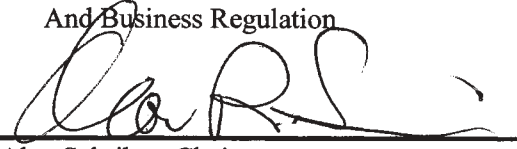

Alan Schriber, Chairman
Ohio Public Utilities Commission



H. Kenneth Haase
Senior Vice President, Transmission
New York Power Authority



Gene Whitney, Policy Analyst
National Science and Technology Council
U.S. Office of Science and Technology
Policy, Executive Office of the President



J. Peter Lark, Chairman
Michigan Public Service Commission



UNITED STATES
NUCLEAR REGULATORY COMMISSION
WASHINGTON, D.C. 20555-0001



Canadian Nuclear
Safety Commission

President and
Chief Executive Officer

Commission canadienne
de sûreté nucléaire

Présidente et
première dirigeante

February 27, 2004

Mr. James Glotfelty
Director, Office of Electric
Transmission and Distribution
U.S. Department of Energy
1000 Independence Ave., Suite 7B-222
Washington, DC 20585

Dr. Nawal Kamel
Special Assistant to the Deputy Minister
Natural Resources Canada
580 Booth Street
Ottawa, ON
K1A 0E4

Dear Mr. Glotfelty and Dr. Kamel:

Enclosed for incorporation into the Task Force report are revisions to the Interim Report and possible recommendations submitted for consideration by the Nuclear Working Group supporting the United States - Canada Joint Power System Outage Task Force. The members of the Nuclear Working Group join us in this submittal and have signed on the attached pages.

Please provide any comments related to the Canadian nuclear plants to either Mr. Pat Hawley (613-947-3992; hawleyp@cnsccsn.gc.ca) or Mr. Mark Dallaire (613-947-0957; dallairem@cnsccsn.gc.ca). Comments on the U.S. nuclear plants should be directed to either Mr. Cornelius Holden (301-415-3036; cfh@nrc.gov) or Mr. John Boska (301-415-2901; jpb1@nrc.gov).

Sincerely,

Nils J. Diaz
Chairman
U.S. Nuclear Regulatory Commission
U.S. Co-chair, Nuclear Working Group

Linda J. Keen
President and Chief Executive Officer
Canadian Nuclear Safety Commission
Canadian Co-chair, Nuclear Working Group

Enclosures: Nuclear Working Group Signature Pages (2)
Nuclear Working Group Final Report

cc w/encls: Mr. Ian Grant
Director General, Reactor Power Regulation
Canadian Nuclear Safety Commission

Mr. Samuel J. Collins
Deputy Executive Director, Reactor Programs
U.S. Nuclear Regulatory Commission

The members of the Nuclear Working Group hereby submit this report as input to the United States - Canada Joint Power System Outage Task Force:



Nils J. Diaz, Chairman
U.S. Nuclear Regulatory Commission
Co-chair, Nuclear Working Group

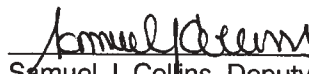

Samuel J. Collins, Deputy Executive Director
for Reactor Programs
U.S. Nuclear Regulatory Commission



William D. Magwood, IV, Director, Office of
Nuclear Energy, Science and Technology
U.S. Department of Energy



Edward Wilds, Bureau of Air Management,
Department of Environmental Protection
(Connecticut)



David O'Connor, Commissioner, Division of
Energy Resources, Office of Consumer
Affairs and Business Regulation
(Massachusetts)

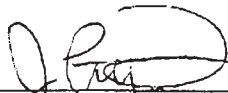

J. Peter Lark, Chairman, Public Service
Commission (Michigan)



Frederick F. Butler, Commissioner, New
Jersey Board of Public Utilities (New Jersey)



Paul Eddy, Power Systems Operations
Specialist, Public Service Commission (New
York)



Dr. G. Ivan Maldonado, Associate Professor,
Mechanical, Industrial and Nuclear
Engineering; University of Cincinnati (Ohio)



David J. Allard, CHP, Director, Bureau of
Radiation Protection, Department of
Environmental Protection (Pennsylvania)



David O'Brien, Commissioner
Department of Public Service (Vermont)

The members of the Nuclear Working Group hereby submit this report as input to the United States - Canada Joint Power System Outage Task Force:



Linda J. Keen
President and Chief Executive Officer
Canadian Nuclear Safety Commission
Co-chair, Nuclear Working Group

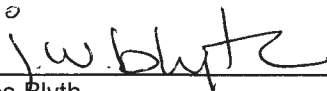

James Blyth
Director-General, Directorate of Nuclear
Substance Regulation
Canadian Nuclear Safety Commission



Ken Pereira
Vice-President, Operations Branch
Canadian Nuclear Safety Commission

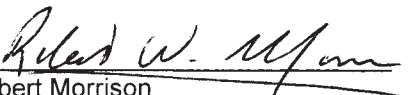

Dr. Robert Morrison
Senior Advisor to the Deputy Minister
Natural Resources Canada



Duncan Hawthorne
Chief Executive Officer
Bruce Power
(Representing the Province of Ontario)

Mr. James W. Glotfelty
Director, Office of Electric Transmission
and Distribution
U.S. Department of Energy
1000 Independence Avenue SW
Washington, DC 20585

Dr. Nawal Kamel
Special Assistant to the Deputy Minister
Natural Resources Canada
580 Booth Street
Ottawa, ON
K1A 0E4

Dear Mr. Glotfelty and Dr. Kamel:

Enclosed is the Final Report of the Security Working Group (SWG) supporting the United States - Canada Power System Outage Task Force.

The SWG Final Report presents the results of the Working Group's analysis of the security aspects of the power outage that occurred on August 14, 2003 and provides recommendations for Task Force consideration on security-related issues in the electricity sector. This report comprises input from public sector, private sector, and academic members of the SWG, with important assistance from many members of the Task Force's investigative team. As co-chairs of the Security Working Group, we represent all members of the SWG in this submittal and have signed below.

Sincerely,

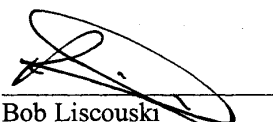

Bob Liscouski
Assistant Secretary for
Infrastructure Protection,
U.S. Department of Homeland Security
Co-Chair, SWG



William J.S. Elliott
Assistant Secretary to the Cabinet,
Security and Intelligence,
Privy Council Office
Government of Canada
Co-Chair, SWG

Attachment 1:

U.S.-Canada Power System Outage Task Force SWG Steering Committee members:

Bob Liscouski, Assistant Secretary for Infrastructure Protection, Department of Homeland Security (U.S. Government) (Co-Chair)	Sid Caspersen, Director, Office of Counter-Terrorism (New Jersey)
William J.S. Elliott, Assistant Secretary to the Cabinet, Security and Intelligence, Privy Council Office (Government of Canada) (Co-Chair)	James McMahon, Senior Advisor (New York)
<u>U.S. Members</u>	John Overly, Executive Director, Division of Homeland Security (Ohio)
Andy Purdy, Deputy Director, National Cyber Security Division, Department of Homeland Security	Arthur Stephens, Deputy Secretary for Information Technology, (Pennsylvania)
Hal Hendershot, Acting Section Chief, Computer Intrusion Section, FBI	Kerry L. Sleeper, Commissioner, Public Safety (Vermont)
Steve Schmidt, Section Chief, Special Technologies and Applications, FBI	<u>Canada Members</u>
Kevin Kolevar, Senior Policy Advisor to the Secretary, DoE	James Harlick, Assistant Deputy Minister, Office of Critical Infrastructure Protection and Emergency Preparedness
Simon Szykman, Senior Policy Analyst, U.S. Office of Science & Technology Policy, White House	Michael Devaney, Deputy Chief, Information Technology Security Communications Security Establishment
Vincent DeRosa, Deputy Commissioner, Director of Homeland Security (Connecticut)	Peter MacAulay, Officer, Technological Crime Branch of the Royal Canadian Mounted Police
Richard Swensen, Under-Secretary, Office of Public Safety and Homeland Security (Massachusetts)	Gary Anderson, Chief, Counter-Intelligence – Global, Canadian Security Intelligence Service
Colonel Michael C. McDaniel (Michigan)	Dr. James Young, Commissioner of Public Security, Ontario Ministry of Public Safety and Security

